



USER MANUAL



SV 104BIS

ACOUSTIC DOSIMETER

Warsaw, 2022-09-23
Rev. 1.02.AUS

Copyright © 2022 SVANTEK.
All rights reserved.



Note: Due to continuous product improvement SVANTEK reserves the right to make changes to product specifications without notice. To download the most up to date User Manual please visit our web site at www.svantek.com.

This User Manual presents the firmware revision **1.08.x**.

This User Manual presents some aspects of Supervisor software revision **1.9.x** and Assistant application for mobile devices revision **2.1.x**.

The succeeding software revisions (marked with the higher numbers) can change the view of some displays presented in the text of this manual.



WEEE Note: Do not throw the device away with the unsorted municipal waste at the end of its life. Instead, hand it in at an official collection point for recycling. By doing this you will help to preserve the environment.

The software described in this manual is furnished under a license agreement and may be used only in accordance with the terms of that agreement.

Copyright Notice

Copyright © 2022 Svantek Sp. z o.o.

All rights reserved.

Reproduction without permission is prohibited.

Trademarks

Trademarks or registered marks in this manual belong to their respective manufacturers.

Microsoft and Windows are registered trademarks of Microsoft Corporation.

The *Bluetooth*[®] word mark and logos are registered trademarks owned by Bluetooth SIG, Inc.

Disclaimer

Information in this document is subject to change without notice and does not represent a commitment on the part of Svantek.

Svantek provides this document “as is”, without warranty of any kind, either expressed or implied, including, but not limited to, its particular purpose. Svantek reserves the right to make improvements and/or changes to this manual, or to the products and/or the programs described in this manual, at any time.

Information provided in this manual is intended to be accurate and reliable. However, Svantek assumes no responsibility for its use, or for any infringements on the rights of third parties that may result from its use.

This product might include unintentional technical or typographical errors. Changes are periodically made to the information herein to correct such errors, and these changes are incorporated into new editions of the publication.

Technical Support Contact Information:

web: www.svantek.com

e-mail: support@svantek.com.pl

GENERAL WARNINGS, SAFETY CLAUSES, AND STANDARD INFORMATION



Note: If the equipment is used in a manner not specified by the manufacturer, the protection provided by the equipment may be impaired.



Note: The **SV 104BIS** dosimeter contains no user serviceable parts. Opening product case invalidates the warranty.



Note: When in normal use, always fit the **SA 122BIS** windscreen provided and make sure there is no display shipping protection foil in place. See Chapters [3.3](#) and [4.2](#).



Note: Under no circumstances should this equipment be cleaned using a solvent based cleaner (it can affect the case polymeric materials). Clean it with water dampened cloth only.



Note: Battery power indicator - To improve accuracy of remaining battery life indicator, run the dosimeter until it is fully discharged; then proceed with a full charge via the docking station. The procedure is recommended before first use. Repeat this procedure every year of use to maintain more accurate current battery condition indication.



Note: If the dosimeter is flooded / falls into water - the device loses the intrinsically safe guarantee and cannot be used in potentially explosive atmospheres.



Note: The dosimeter should be periodically checked that it does not become unsealed, e.g. as a result of a fall, because then it loses IP65 (Ingres Protection) rating.



Note: Dosimeter incorporates Bluetooth^{®1} wireless communication operating in 2.4GHz RF band and transmit power up to +9dBm.



Note: For air-transport turn off **Bluetooth interface** (Chapters [3.8.3](#), [6.3.9.4](#) and [7.8](#)).

¹ "The Bluetooth[®] word mark and logos are registered trademarks owned by Bluetooth SIG, Inc. and any use of such marks by SVANTEK is under license. Other trademarks and trade names are those of their respective owners.

HAZARDOUS AREA INSTALLATIONS SPECIFIC INFORMATION

The **SV 104BIS** instrument is designed to be used in potentially explosive environments.

1. The equipment shall only be charged in non-hazardous area by manufacturer's **chargers on a fireproof surface**. The recommended charging docking stations: **SB 104B-1** and **SB 104B-5**.
2. Whenever it is likely that the correct function or operating safety of the apparatus has been impaired, it must be made inoperative and be secured against unintended operation.
3. The dosimeter should be **mounted on conductive clothes and/or with direct contact with human body**. This assures a path to remove the accumulated electrostatic charge that could built-up on dosimeter.
4. Some parts of the enclosure are non-conducting and may generate an ignition-capable level of electrostatic charge under certain extreme conditions. The user should ensure that the equipment is not installed or used in a location where it may be subjected to extreme conditions (such as high-pressure steam), which might cause a build-up of electrostatic charge on non-conducting surfaces. Additionally, cleaning of the equipment should be done only with a water dampened cloth.
5. Before entering hazardous zone **check if there is no display shipping protection foil in place**, which is used on new products being sent to protect from accidental scratches. See Chapter [4.2](#).
6. The SV 104BIS instrument shall not be used in areas where a layer of coal dust may be deposited on the enclosure.
7. The microphone **windscreen and microphone should not be removed in a hazardous area**.
8. The equipment may be used with flammable gases and vapours with apparatus Groups IIA, IIB and IIC and with temperature classes T1, T2, T3 and T4.
9. The equipment is only certified for use in ambient temperatures in the range **-10°C to +50°C** and should not be used outside this range.
10. If the equipment is likely to come into contact with aggressive substances, then it is the responsibility of the user to take suitable precautions that prevent it from being adversely affected, thus ensuring that the type of protection is not compromised. Aggressive substances e.g. solvents may affect polymeric materials.
11. Any substitution of components may impair intrinsic safety.
12. Repair and **battery replacement of this equipment shall only be carried out by the manufacturer or by authorized and trained service personnel**. Any adjustment, maintenance and repair of the open apparatus under voltage must be avoided as far as possible and, if unavoidable, must be carried out only by trained service.
13. Calibration with non-intrinsically safe calibrators must only be performed on the **SV 104BIS** in a non-hazardous atmosphere.
14. The SA 123IS and SA 124IS optional mounting accessories are made of natural leather, stainless steel and EN 1149 antistatic velcro. Because the EN 1149 test may not reflect the conditions of end use, those responsible for Health & Safety in the work environment should perform an in-use test to determine if the additional accessories being considered as part of the total earthed system, is compatible with their requirements for protection against electrostatic discharge.

SPECIAL PRECAUTIONS WHEN USING AND CHARGING LITHIUM BATTERIES






SV 104BIS instrument contains extremely high energy density lithium-ion cell. Use special caution when working with lithium-ion cells. They are very sensitive to charging conditions and may explode or burn if mishandled.

- Do not replace the battery yourself. The battery is only manufacturer replaceable.
- Do not charge the instrument underground (mining) or in other hazardous locations.
- Always charge lithium batteries on a fire-proof surface.
- Do not charge the instrument near flammable materials such as boxes, paper and furniture.
- Immediately discontinue use of the instrument, while using, charging, or storing the instrument, if the instrument emits an unusual smell, feels hot, changes colour, changes shape, swells, or appears abnormal in any other way. Contact your sales location or **SVANTEK** if any of these problems are observed.
- Use caution to prevent puncturing or rupture of the instrument and cell within. Do not penetrate the instrument with nails, strike the instrument with a hammer, step on the instrument, or otherwise subject it to strong impacts or shocks.
- Do not place the instrument on or near fires, stoves, or other high-temperature locations. Do not use or store the battery inside cars in hot weather. Do not place the instrument in direct sunlight or use or store the instrument near a source of heat. Doing so may cause the battery contained inside to generate heat, explode, or ignite. Using the instrument in this manner may also result in a loss of performance and a shortened life expectancy.
- Do not place the instrument in microwave ovens, high-pressure containers, or on induction cooktop.
- Although the instrument is IP65 protected do not expose it extensively to water conditions which could cause the contained battery to get wet.
- The temperature range over which the instrument can be charged is **0°C to 35°C**. Charging the instrument at temperatures outside of this range may cause the battery to become hot or to break. Charging the instrument outside of this temperature range may also harm the performance of the battery or reduce the battery's expectancy.

Assure that all of these precautions are observed before leaving the instrument charging unattended.

- The temperature range over which the battery can be stored is -20°C to +50°C and the temperature range over which the battery can be discharged is -10°C to +50°C. Use of the battery outside of this temperature range may damage the performance of the battery or may reduce its life expectancy.
- If you notice a performance decrease of greater than 20% in instrument, the battery is at the end of its life cycle. Do not continue to use, and ensure the battery is disposed of properly. Contact your sales location or **SVANTEK**.

ENVIRONMENTAL PROTECTION MARKING OF THE UNIT

Marking on the Unit	Explanation
IP65	Dust-tight. Protected against water jets
	ATTENTION, CONSULT ACCOMPANYING DOCUMENTS
	Do not throw into standard municipal waste containers. The user is obliged to deliver used equipment to the manufacturer or to the recycling collection point
	This product has met EU consumer safety, health or environmental requirements
	This product has met ATEX explosive protection directives requirements
	This product can be recycled (sign is placed on the battery)

INDEX

1

1/1-octave analyser · 28
1/1-octave settings · 64
1/3-octave analyser · 29
1/3-octave settings · 64

A

Accessories · 17
Alarm · 31, 51
Alternate key functions · 25
Applications · 15
Assistant · 46
Audio recording · 68
Auxiliary settings · 66

B

Battery · 31
Battery check · 36
Bluetooth · 31, 44, 45, 47, 66

C

Calibration · 38, 65, 87
Calibration factor · 38
Charging · 33
Cleaning · 87
Combined keys functions · 26
Configuration panel · 55, 61
Control panel · 55

D

Dosimetry · 14

E

E-mail notification · 51

F

File manager panel · 55
Files downloading · 70
Files manager · 70
Files unloading · 70
Firmware update · 88

G

General settings · 64

I

Icons · 23
Instrument control · 24, 48
Instrument status view · 31
Interfaces · 20
Inventory panel · 55

K

Keypad · 24, 65
Keypad locking · 65

L

Language · 66
LED indicator · 22

M

Measurement procedures · 16
Measurement settings · 61
Measurement start · 42
Measurement stop · 42
Microphone · 88
Mobile device · 46
Mounting · 22
Mounting clips · 21

O

One result view · 27

P

Periodic testing · 88
Positioning · 22
Primary key functions · 24
Profiles · 27

R

Report · 79

Reset · 44, 45
Results list view · 28
Results view · 50
Risk mitigation · 90
Running SPL view · 27

S

Sampling frequency · 69
Security lock · 43
Session · 79
Settings · 58
Setup · 31, 37, 58
Signal recording · 68
SMS notification · 51
Software options · 18
Sound pressure · 14
Spectrum view · 28, 29
Standards · 14
Statistics · 65
Storage · 89
Supervisor · 54
Svantek service · 91

T

Threshold level · 69

Time-history settings · 62
Timer · 31, 43, 67
Transportation · 89
Troubleshooting · 89
Turning off · 35
Turning on · 35

U

Unit label · 36
Unit name · 36

V

Vibration marker · 66
View mode · 27
Views settings · 63
Voice comments · 41

W

Wave · 68
Wave recording · 68
Windscreen · 21, 88

CONTENTS

<u>GENERAL WARNINGS, SAFETY CLAUSES, AND STANDARD INFORMATION</u>	3
<u>HAZARDOUS AREA INSTALLATIONS SPECIFIC INFORMATION</u>	4
<u>SPECIAL PRECAUTIONS WHEN USING AND CHARGING LITHIUM BATTERIES</u>	5
<u>ENVIRONMENTAL PROTECTION MARKING OF THE UNIT</u>	6
<u>INDEX</u>	7
1 INTRODUCTION	13
1.1 Sound pressure	14
1.2 Dosimetry	14
1.3 Standards	14
1.4 Applications	15
1.5 Measurement procedures	16
2 KIT COMPONENTS	17
2.1 SV 104BIS dosimeter short form specification	17
2.2 Accessories included	17
2.3 Accessories available	18
2.4 Firmware options available	18
3 GETTING STARTED	19
3.1 System description	19
3.2 Input / output interfaces	20
3.3 Windscreen	21
3.4 Mounting clips	21
3.5 Mounting and positioning SV 104BIS	22
3.6 LED status indicator	22
3.7 Status bar icons	23
3.8 Manual control of the instrument	24
3.8.1 Primary key functions	24
3.8.2 Alternate key functions	25
3.8.3 Alternate combined keys functions	26
3.9 Three instruments in one – ACOUSTIC PROFILE concept	27
3.10 The VIEW mode presentation concept	27
3.10.1 Running SPL view mode	27
3.10.2 Primary “ONE RESULT” view mode	27
3.10.3 RESULTS LIST view mode	28
3.10.4 1/1-octave analysis spectrum view mode	28
3.10.5 1/3-octave analysis spectrum view mode	29
3.10.6 INSTRUMENT STATUS view mode and Bluetooth security PIN code	31
3.11 ALARM screen review	31

4	RUNNING AND OPERATING BASIC PROCEDURES	33
4.1	Charging SV 104BIS	33
4.2	Before you turn the instrument on	34
4.3	Turning on/off	35
4.4	Battery check	36
4.5	Reviewing unit label	36
4.6	Measurement setup - basic configuration	37
4.7	Calibration	38
4.8	Voice comments recording	41
4.9	Before and after measurement run	42
4.10	Starting and stopping measurement run	42
4.11	Auto-run mode information	43
4.12	Security lock	43
4.13	Reviewing measurements	43
4.14	Control of the instrument via Bluetooth® wireless interface	44
4.15	Switching off microphone compensation	44
4.16	Data downloading and uploading	45
4.17	Resetting dosimeter	45
5	ASSISTANT MOBILE APPLICATION	46
5.1	Installing Assistant on a mobile device	46
5.2	Connection via Bluetooth®	47
5.3	Control via Bluetooth®	48
5.3.1	Instruments' status screen	48
5.3.2	Results view / control screen	50
5.3.3	SMS and e-mail notifications	51
5.4	Checking the software version and exiting the application	53
6	SUPERVISOR BASIC OPERATIONS	54
6.1	Installing and connecting	54
6.2	Supervisor main window	55
6.3	Editing the instrument's settings	58
6.3.1	Editing settings	59
6.3.2	Applying settings	59
6.3.3	Using presets	60
6.3.4	Profile settings	61
6.3.5	Measurement parameters settings	61
6.3.6	Time-history data logging settings	62
6.3.7	VIEW configuration	63
6.3.8	Spectrum configuration	64
6.3.9	General settings	64
6.3.9.1	Calibration	65
6.3.9.2	Statistical levels	65

6.3.9.3	Keyboard security	65
6.3.9.4	Auxiliary settings	66
6.3.10	Auto-Run settings (timer, pauses)	67
6.3.11	Recording options	68
6.3.11.1	Wave recording configuration	68
6.4	Working with data files	70
6.4.1	Downloading files	70
6.4.2	Data Browser	71
6.4.2.1	File Manager	72
6.4.2.2	File details	73
6.4.2.3	File preview	75
6.4.2.4	Using assignments	76
6.4.2.5	Summary reports	77
6.5	Sessions and reporting	79
6.5.1	Creating and managing sessions	79
6.5.2	Validation tool	81
6.5.3	Session's Tollbar	82
6.5.4	Session source data	83
6.5.5	Session Panels	83
6.5.6	Generating reports from sessions	85
7	SV 104BIS MAINTENANCE	87
7.1	General recommendations for use	87
7.2	Cleaning	87
7.3	In situ calibration	87
7.4	Periodic testing	88
7.5	Changing the microphone and windscreen	88
7.6	Firmware update	88
7.7	Storing the instrument	89
7.8	Transportation and carrying	89
7.9	Troubleshooting	89
8	RISK ASSESSMENT AND MITIGATION OF RISK	90
9	SVANTEK SERVICE	91
APPENDIX A	REMOTE CONTROL	92
A.1	Input / Output transmission types	92
A.2	FUNCTION #1 - Input/Output of the control setting codes	92
A.3	FUNCTION #2 - measurement results read-out in DOSE METER mode	94
A.4	Function #3 - Read-out of the measurement results in 1/1 OCTAVE or 1/3 OCTAVE mode	96
A.5	FUNCTION #4 - read-out of the data file from the internal Flash-Disk or RAM memory	96
A.6	FUNCTION #5 - statistical analysis results read-out	97
A.7	FUNCTION #7 - special control functions	98
A.8	FUNCTION #9 - write-in the data file into the internal flash-disc	103

A.9 Function #D – Read / Write the data files from the external memory (SD Card)	103
A.10 Control setting codes	105
APPENDIX B DATA FILE STRUCTURES	108
B.1 General structure of the SV 104BIS file	108
B.2 Structure of the file containing results from logger's file	123
B.2.1 The contents of the files in the logger	123
B.2.1.1 Record with the results	123
B.2.1.2 Record with the state of the markers	124
B.2.1.3 Record with the breaks in the results registration	125
B.2.1.4 Record with the breaks account PAUSE in the results registration	125
B.2.1.5 Record with the wave file name	125
B.2.1.6 Record with Summary Results	125
B.2.1.8 Record with name of the comment file	126
APPENDIX C TECHNICAL SPECIFICATIONS	128
C.1 Specification of SV 104BIS as DOSIMETER	128
C.1.1 Specification of SV 104BIS as dosimeter in standard configuration	128
C.2 Specification of the SV 104BIS as 1/1 and 1/3 OCTAVE ANALYSER	158
C.3 Frequency characteristics of the implemented digital filters	167
C.4 General specification of the SV 104BIS	169
APPENDIX D DEFINITIONS AND FORMULAE OF MEASURED VALUES	173
D.1 Basic terms and definitions	173
D.2 Definitions and formulas of the SLM function results	175
D.3 Definitions and formulas of the additional Dosimeter function results	177
D.4 Statistical levels – Ln definition	179

1 INTRODUCTION

Now, the **SV 104BIS** instrument is even more revolutionary approach to occupational health and safety noise monitoring offering **voice comments**, **signal recording** and **vibration shock detection** functions which are new and useful concepts in an instrument of this size. It is a cable-free dosimeter and is typically attached to the user's shoulder, close to the ear using the mounting clips supplied.

This personal dosimeter has an **incredibly robust** 1/2" MEMS microphone (part number **ST 104B**) enabling easy and automatic calibration using most commonly available acoustic calibrators.

The class beating, high resolution, **amazing colour OLED** screen displays information in both text and graphical form and offers excellent visibility in dark sites as well as in full daylight conditions. This makes taking noise measurement a real pleasure.

Three independent acoustic profiles allow parallel measurements with separately defined filters and RMS detector time constants. Each profile provides an extensive number of results (like **Leq**, **Lmax**, **Lmin**, **Lpeak**, **L**, **LE**,...). All required weighting filters (**A**, **C**, **Z**) can be calculated in parallel.

For instance, it is trivial to set one profile to monitor noise parameters using the ACGIH (American Conference of Governmental Industrial Hygienists) pre-set, second profile set to OSHA HC (Occupational Safety and Health Administration - Hearing Conversation) pre-set and simultaneously monitor noise with the OSHA PEL (Occupational Safety and Health Administration – Permissible Exposure Level) settings.

Using the computational power of its digital signal processor the SV 104BIS instrument can simultaneously measure the dosimeter results and perform real time **1/1 Octave** & **1/3 Octave** analyses including calculations of statistical levels.

An inbuilt tri-axial accelerometer for **vibration shock detection** firmly places SV 104BIS as both the most technically advanced and the most robust personal dosimeter out there providing also information on the time when dosimeter is not used by the worker.

Advanced **time history logging** for each profile provides safe and complete information about measured signal in the internal **large 8GB memory**.

The instrument is powered from internal new generation Li-ion **rechargeable batteries** offering circa **45 hours²** of continuous operation. Ultra-low battery self-discharge is about 1% per year. The **powering and charging** of the instrument is possible with the use of **SB 104B-1** or **SB 104B-5 docking station** with the USB interface enables easy data exchange with a PC.

The instrument works with Svantek dedicated health and safety software packages – **Supervisor**, mobile **Assistant**, and also with the full analysis package **SvanPC++**.

Robust and lightweight design and Low Energy **Long Range Bluetooth® Smart** wireless interface enhances the exceptional features of this new generation instrument. Add to it the **automatic calibration** feature and one can say: "Never before has a noise dosimeter been so accomplished yet so affordable, making your measurements more **accurate and reliable than ever before**".

To get started quickly with SV 104BIS, the first part of the manual describes basic noise dosimetry information followed by a guide to setting up the dosimeter and running measurements.

² Depending on configuration.

1.1 SOUND PRESSURE

The human ear responds to audible sound pressure levels in the range from 20 μ Pa (hearing threshold) to 20 Pa (pain threshold), resulting in the enormous scale 1:1,000,000. Since using such a large arithmetic scale is not practical, a logarithmic scale in decibels (dB) was introduced which is also in agreement with physiological and psychological hearing sensations. Therefore, it is common that sound pressure is measured in decibels. Below there is sample information about expected sound levels for different sources.

Sound source	Sound level [dB]
Jet aircraft, 50 m away, or gunshot at close range	140
Threshold of pain	130
Threshold of discomfort	120
Chainsaw, 1 m distance	110
Disco, 1 m from speaker	100
Vacuum cleaner, distance 1 m	70
Conversational speech, 1 m	60
Quiet library	40
Rustling leaves	10
Hearing threshold	0

Table 1-1 Example sound source levels

1.2 DOSIMETRY

Noise is definitely a serious hazard in many workplaces. In case exposure to noise from machinery processes and equipment is not correctly eliminated or controlled, it may cause permanent hearing loss in workers. The, so called, inner ear is very fragile part of our hearing sense, which with current knowledge in medicine, cannot be truly repaired. Therefore, it is of great importance to protect our senses from excessive noise. Exposure to high levels of noise may also create physical and psychological stress, reduce productivity and interfere with normal communications. This may lead to accidents and injuries by making it difficult to hear moving equipment, other workers, and warning signals. Undoubtedly hearing loss has a very significant impact on the quality of life for many workers and their families.

Therefore, measuring noise exposure in the workplace is fundamental part of all good hearing conservation and noise reduction programs. The aim of taking a measurement with a noise dosimeter is to evaluate the average exposure of employees to noise during a normal shift. Wherever the worker goes the noise dosimeter goes too so that it captures all of the harmful noise during the typical day.

The dosimeter may be worn for the complete shift if the work pattern is so variable that it is difficult to predict exactly what will occur or it may be worn for a shorter but representative period and then the full day's dose extrapolated from that sample.

1.3 STANDARDS

The effects of high sound exposure on hearing have been studied for many years. As far back in 1954 AIHA (American Industrial Hygiene Association) – Rosenwinkel & Stewart – described a “new device which integrates sound energy over finite time periods.” In 1956 – von Witternand & von Gierke obtained a patent for a noise exposure meter for “indicating the total time that noise exceeded a certain predetermined level”. Since

then, measurements could be conducted over long periods of time and the instrument was worn by personnel under normal work conditions.

Finally, organizations developed standards to regulate personal noise exposure. International standards are specified by health and safety regulations such as the European Union Parliament and Council Directive 2003/10/EC of February 6, 2003 on minimum health and safety requirements regarding the exposure of workers to the risks arising from physical agents (noise) or International Electrotechnical Commission IEC 61252 guidelines. The EU directive links to the ISO 9612:2009 Acoustics – Determination of occupational noise exposure – Engineering method.

In the United States, the Occupational Safety and Health Administration (OSHA) 29 Code of Federal Regulations (CFR) 1910 General Industry Regulations: Standard No. 1910.95 Occupational noise exposure, the Mine Safety and Health Administration (MSHA), and the American Conference of Governmental Industrial Hygienists (ACGIH) have created slightly different regulations and limitations on tolerable noise exposure. Noise requirements are to ensure that the hazards associated with the exposure of workers to noise are eliminated or properly controlled.

Organization	Website address
ISO	http://www.iso.org
IEC	http://www.iec.ch
OSHA	http://www.osha.gov
MSHA	http://www.msha.gov
NIOSH	http://www.cdc.gov/niosh
ACGIH	http://www.acgih.org
CCOHS	http://www.ccohs.ca
...	

Table 1-2 Standardization organizations' websites

Additionally, at present dosimeters should meet relevant accuracy and performance requirements defined by:

- **IEC 61252** Personal Sound Exposure Meters
- **ANSI S1.25** Personal Noise Dosimeters

1.4 APPLICATIONS

The SV 104BIS noise dosimeter is extremely well suited to ISO, OSHA, ACGIH, MSHA, NIOSH, CFR 1910.95, HSE L108 workplace noise measurements in noise exposure assessments. NIHL: Noise Induced Hearing Loss remains noticeably significant occupational disease. It is notably severe in the mining, construction, oil & gas industry but also in a wide variety of manufacturing sectors and other commercial operations. The dosimeter comes with pre-defined setups that suit different measurement requirements and offer versatile possibilities to be specifically configured by the user for special requirements if needed:

- measurement and control of the industrial noise
- work site assessments
- sites/plants/facilities survey monitoring systems
- hearing conservation compliance, noise induced hearing loss (NIHL)
- transportation noise studies
- personal noise verifications
- peak dosimeter for example in military applications.

One of the most desirable SV 104BIS features is the unique data logging function that stores significant number of noise parameters at regular intervals and superimposed random vibration shock or audio events during a measurement run.

Due to the unattended nature of noise dosimetry, it is important for workers to be fully engaged with the risk assessment process. Motion sensing (No Motion Time) is particularly useful in cases of cheating to tamper with the instrument or try to impact on the results, by for example instrument being taken off for the majority of the time.

The addition of Bluetooth® wireless connectivity and the supporting mobile devices **Assistant** application enables remote control and monitoring of the instrument's status such as battery usage, memory capacity and measurement progress without having to disturb the worker.

Noise profiled results can be easily transferred to the **Supervisor** or **SvanPC++** software packages. The noisiest times can be immediately seen in the graphical report and actions directed to the appropriate area. This makes checking for different regulatory bodies' compliance and ensuring if hearing conservation programs are needed definitely easier than ever before. SV 104BIS answers all the important questions such as WHEN and HOW did the noise exposure appear? The data logging measurements can be started immediately, or they can be pre-programmed in advance so that measurement run can begin and end automatically at a pre-set start and end time without the need for any onsite supervision.

Additionally, SV 104BIS allows for custom **voice note comments** to be added before or after the measurement run, and therefore this is the ideal instrument for the professional occupational hygienist to use for all noise exposure studies.

1.5 MEASUREMENT PROCEDURES

Preferably, when taking measurements, the noise dosimeter should be attached to the employee at the start of a shift and collected at the end of the whole shift. In case a shorter period is sampled then care should be taken to ensure that the result is representative of the full shift exposure. Shorter sampled periods require that the sampler has a deep and full understanding of the expected working tasks during the shift and the duration cycles of those tasks.

Before performing any noise measurements, ensure that employees selected for evaluation are operating equipment or performing tasks under normal (representative) conditions, and emphasise the importance of continuing to work in their usual manner (wearing the dosimeter should not interfere with normal duties). Explain the purpose and procedures of sampling to the employee who will be wearing the dosimeter and the importance of not touching, tapping or interfering with the microphone. Instruct the employee not to remove the dosimeter unless absolutely necessary.

The general procedure for taking measurements could be as follows:

1. Check that the indicated instrument battery life is at least twice the time required for the measuring period.
2. Check the instrument setup mode is appropriate and change if necessary.
3. Check the calibration of the instrument and adjust the settings if required.
4. Secure the instrument onto the shoulder of the employee selected for sampling. Refer to the chapter with specific requirements regarding orientation of the microphone.
5. Start the recording session manually if it is not programmed for an automatic timed start.
6. At the end of the measurement period, stop the recording session, and remove the dosimeter from the employee.
7. Recheck the dosimeter's calibration. If the instrument is not within the calibration limits then the results are invalid (usually if a discrepancy is found between two successive checks of more than $\pm 0.5\text{dB}$ in the reference level, then the results of the measurements taken between the two checks should be considered invalid and the cause investigated, and the measurement repeated).
8. Follow your organisation's specific procedure for personal noise exposure recordings analysis
9. Ensure the report is submitted to the appropriate person.
10. Distribute copies of noise exposure recordings to test participants, explain the results and ensure that their hearing protection adequately protects against the recorded noise exposure levels.

2 KIT COMPONENTS

2.1 SV 104BIS DOSIMETER SHORT FORM SPECIFICATION

- Acoustic Dosimeter conforming to the IEC 61252 ed1.2 (2017), ANSI/ASA S1.25-1991 (R2017), Class 2 IEC 61672-1 ed2.0 (2013), IEC 61010-1 (2010), IEC 60079-0 ed7.0 (2017), IEC 60079-11 ed6.0 (2011), CAN/CSA C22.2 No 61010-1; CAN/CSA C22.2 No 60079-0; CAN/CSA C22.2 No 60079-11, ANSI/UL 61010-1; ANSI/UL 60079-0; ANSI/UL 60079-11 standards
- **ST 104B** MEMS microphone, 1/2" housing, patented, with **LIFETIME WARRANTY!**
- **OLED colour display** (128 x 64 pixels) with super brightness and contrast
- Large **8 GB memory**
- Wireless connectivity with low energy **Long Range Bluetooth® Smart** (5.2) interface
- **USB 2.0** high speed interface (available only through the docking station)
- Parallel **Slow, Fast, Impulse** detectors for the measurements with **A, C, Z** filters
- Frequency Range **20 Hz ÷ 10 kHz**
- Measurement range better than **53 dBA RMS ÷ 143 dBA Peak**
- Dynamic Range better than **100 dB**
- Exchange rates **2, 3, 4, 5, 6**
- Measurement results: **Run Time (TIME), Lpeak, Lmax, Lmin, L, DOSE (%), D_8h, PrDOSE, Leq, LAV, LE, SEL8, E, E_8h, LEPd, PSEL, Ltm3, Ltm5, Lstat, PTC, PTP, ULT, TWA, PrTWA, Lc-a, OVL, No Motion Time**
- **3** independent user configurable acoustic measurement profiles
- Easy in use **predefined setups**
- **Time-history data logging** of Leq/Lav/Lmax/Lmin/Lpeak with variable 0.1 s to 1 hr logger step and separate summary results intervals with statistical levels
- **1/1 Octave** real time analysis - 9 filters with centre frequencies from 31 Hz to 8 kHz (meeting Class 1 requirements of IEC 61260-1:2014) presented as a bar graph with Leq and Lmax band levels plus overall A, C and Z broadband weightings (as option called SF 104BIS OCT)
- **1/3 Octave** real time analysis - 28 filters with centre frequencies from 20 Hz to 10 kHz (meeting Class 1 requirements of IEC 61260-1:2014) presented as a bar graph with Leq and Lmax band levels plus overall A, C and Z broadband weightings (as option called SF 104BIS 3OCT)
- **Wave recording**, triggered and continuous mode, 12/24 kHz sampling rate, WAV format (as option called SF 104BIS WAV)
- **Voice Comments** records audio on demand, created before or after measurement, added to measurement file
- **Vibration shock detector** with user selectable variable threshold: 1g-15g
- **Automatic acoustic field calibration** with one touch activation before and after measurement
- Operational time > **45 hours** (*display off, Bluetooth® off, octave analysis off*)
- Extremely **compact, lightweight** and **robust** case with **IP65** ingress protection

2.2 ACCESSORIES INCLUDED

- **ST 104B** 1/2" MEMS microphone for the SV 104BIS dosimeter
- **SA 122BIS** foam windscreen

2.3 ACCESSORIES AVAILABLE

- **ST 104B** ½" MEMS microphone for the SV 104BIS dosimeter
- **SA 122BIS_3** Windscreens for the SV 104BIS dosimeter 3 pcs per pack
- **SV 34B** Class 2 acoustic calibrator: 114dB@1000Hz
- **SB 104B-1** 1-bay docking station (including **SC 16** – USB type A to USB type B cable)
- **SB 104B-5** 5-bay docking station with **SB 33** power supply (including **SC 16** – USB type A to USB type B cable)
- **SC 104BT** Equivalent Impedance for electrical calibration
- **SA 144** Carrying Case for 5 Dosimeters and Docking Station for 5 Units
- **SA 147** Waterproof Carrying Case for Noise Dosimeter and Single Docking Station
- **SA 123IS** Hard hat mounting accessory for the SV 104BIS dosimeter
- **SA 124IS** Harness mounting accessory for the SV 104BIS dosimeter



Note: *SV 34B, SB 104B-1, SB 104B-5, SB 33, SC 16, SC 158, SA 147, SA 73, SC 104BT are not intrinsically safe and therefore cannot be used in hazardous areas (a flammable or combustible atmosphere.)*



Note: *SA 123IS and SA 124IS are made of natural leather, stainless steel and EN 1149 antistatic velcro. because the EN 1149 test may not reflect the conditions of end use, those responsible for Health & Safety in the work environment should perform an in-use test to determine if the additional accessories being considered as part of the total earthed system, is compatible with their requirements for protection against electrostatic discharge.*

2.4 FIRMWARE OPTIONS AVAILABLE

- **SF 104BIS OCT** real time 9 band 1/1-octave analysis option
- **SF 104BIS 3OCT** real time 9 band 1/1-octave and 28 band 1/3-octave analysis option
- **SF 104BIS WAV** wave recording option



Note: *Software options can be purchased in any time as only the introduction of a special code is required for their activation. The activation of the optional functions can be made with the use of the Supervisor software – see Chapter [6.2](#).*

3 GETTING STARTED

3.1 SYSTEM DESCRIPTION

The following figure shows the SV 104BIS controls and ports:



Figure 3-1 SV 104BIS at a glance

3.2 INPUT / OUTPUT INTERFACES

SV 104BIS is equipped with a set of useful interfaces:

- microphone connector (essential for measuring)
- charging connector and fast communication port (reserved for docking stations)
- Bluetooth® 5.2 wireless connectivity and the supporting mobile devices **Assistant** application enables remote control and monitoring of the instrument's results and status

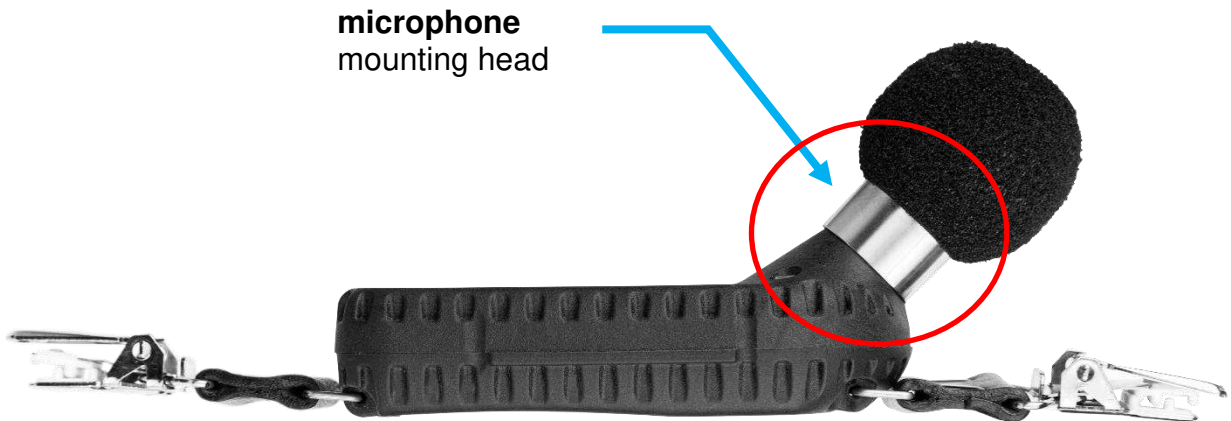


Figure 3-2 SV 104BIS side view – microphone connector

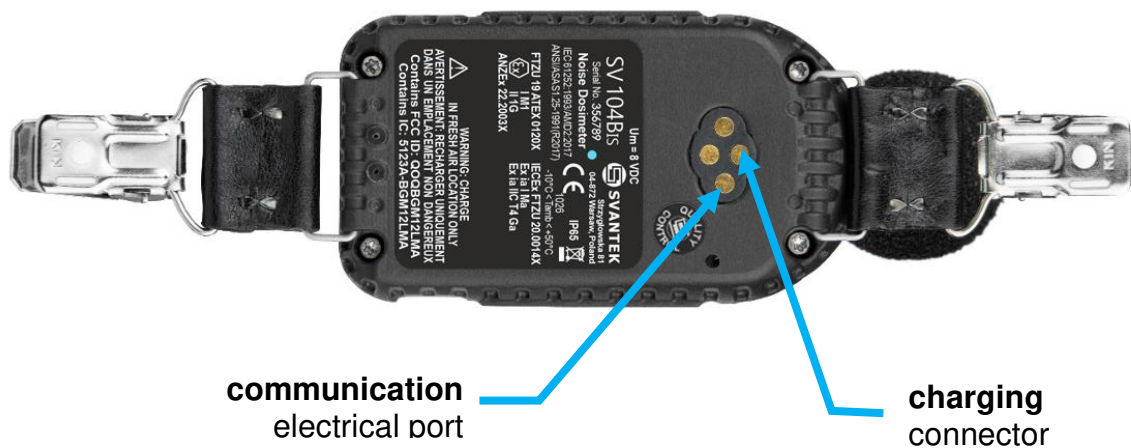


Figure 3-3 SV 104BIS back view - charging and communication port (reserved for docking stations)



Note: Full description of the connectors is given in Appendix C.

3.3 WINDSCREEN

During use, it is strongly recommended that SV 104BIS is fitted with the supplied **SA 122BIS** antistatic windscreen. To calibrate the dosimeter, it is necessary to remove the windscreen to gain access to the microphone. It is not necessary to remove the windscreen to record the voice note comments.

SV 104BIS uses windscreen with reliable screwed technique to fit tightly onto the microphone housing. To remove the windscreen just unscrew it by holding the lower half of the foam and windscreen housing. See the markings engraved to unscrew. Once SV 104BIS has been calibrated, refit the windscreen by carefully screw it back over the microphone again.



Figure 3-4 SA 122BIS windscreen

3.4 MOUNTING CLIPS

Upon delivery, SV 104BIS will be fitted with the standard mounting clips made of natural leather. Mounting clips can be changed using a pliers.



Figure 3-5 SV 104BIS standard mounting clips

3.7 STATUS BAR ICONS

The upper part of the display is designed as basic status information provider. See the description below.

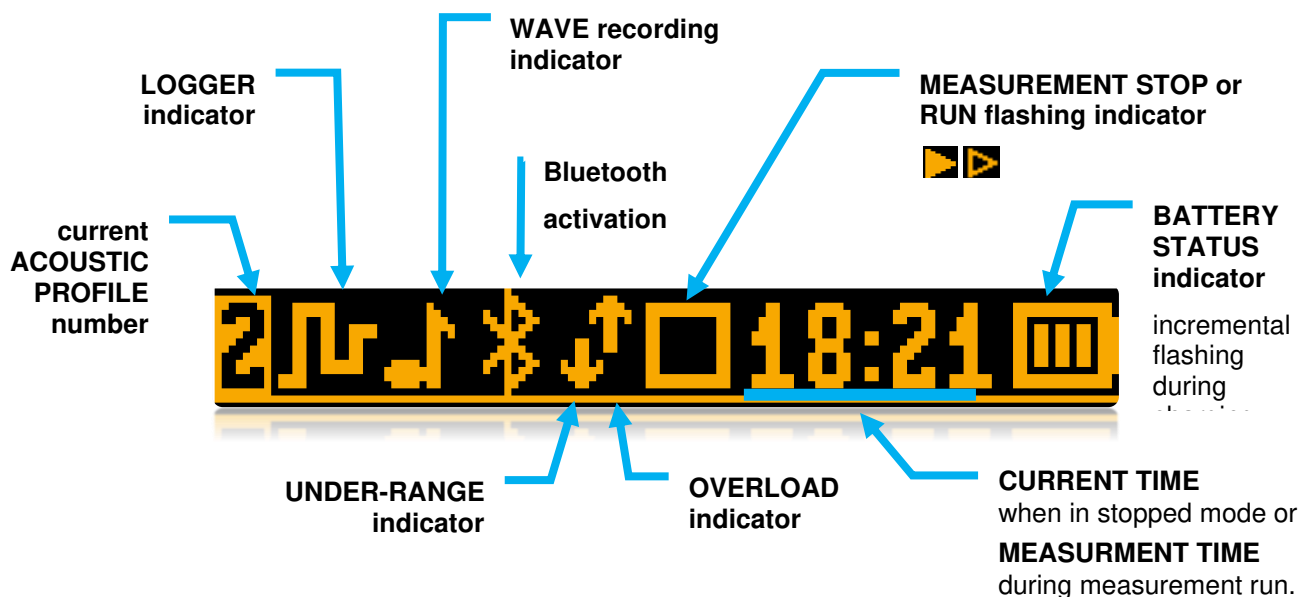



Figure 3-7 SV 104BIS display icons description

Overload detector

The instrument has the built-in overload detectors. Both A/D converter and input amplifier overload conditions are detected. The overload in the measurement channel (in its analogue part) and the overload of the analogue / digital converter are both detected. The “overload” indication appears when the input signal amplitude is 0.5 dB above the declared “Peak measurement range”. This condition is checked once per second or with the Logger Step if it is less than 1 second.


An overload is indicating by the flashing  icon which is displayed during the period from the overload detection till the end of the Integration Period. If the overload disappears to the Integration Period end, the overload icon will not be displayed from the start of the next measurement cycle.

When an overload is detected, the special marker will be recorded to the logger file with the data logging step.

The overload time is measured by the OVL result during the Integration Period and is saved in the logger file as part of Summary Results.

Underrange detector




The instrument has the built-in underrange detector. The “underrange” indication appears when the RMS value for the elapsed time is below the lower linear operating range. This is checked once per second.

An underrange is indicating by the flashing  icon which is displayed during the period of the underrange detection. When an underrange is detected till the Integration Period, the special marker will be recorded to the logger file with the Integration Period step. If during the Integration Period the signal level increases and the total RMS is greater than the minimum, the icon stops displaying and the underrange marker is not recording.

3.8 MANUAL CONTROL OF THE INSTRUMENT

Although the Instrument is small, its keypad is designed to be minimal, but still highly ergonomic and easy to use providing effective operational capabilities. Thanks to that, the number of the control keys of the instrument is reduced to only three.

Generally, the user can operate the instrument by:

- changing the **VIEW** mode with the  key
- selecting the required **ACOUSTIC PROFILE** with the  key
- scrolling through the results with the  key.



Note: To save power consumption and extend battery life SV 104BIS will automatically switch off the display after 30 seconds if no button on the keypad is pressed. The LED indicator will still inform the user about the current state of operation and any possible alarm conditions. Press any key, to reactivate the display.

3.8.1 Primary key functions

On the front panel of the instrument the following control keys are located. See below for primary (short press) key functions description:

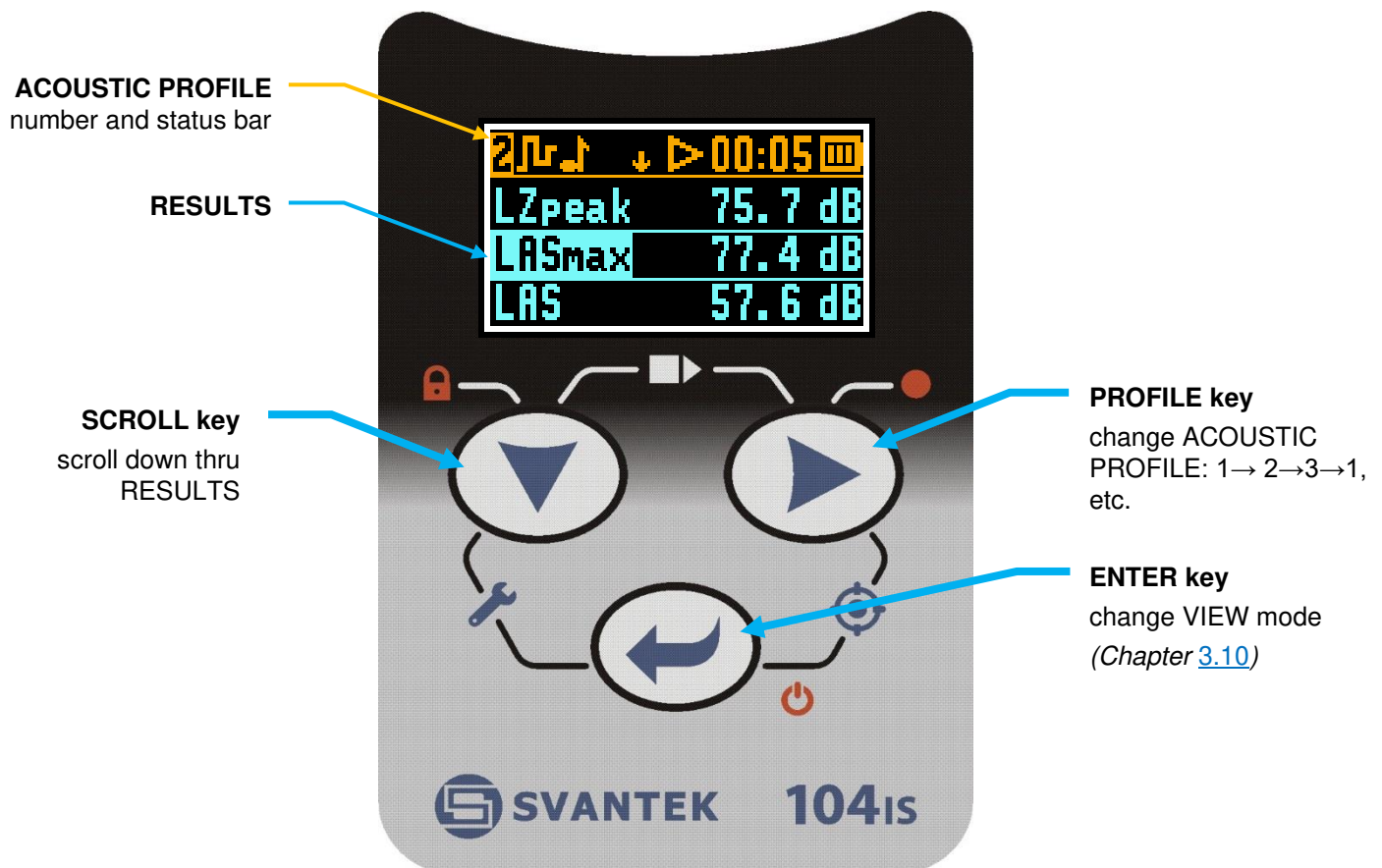





Figure 3-8 Control keypad on the front panel – primary key functions

3.8.2 Alternate key functions

Alternative **long press of a single key** (keypad icons marked with red colour) allows quick access to special functions:

- **POWER ON/OFF** the unit by holding down the  key
- Record the **VOICE COMMENT** by holding down the  key
- **LOCK** keypad and screen by holding down the  key.

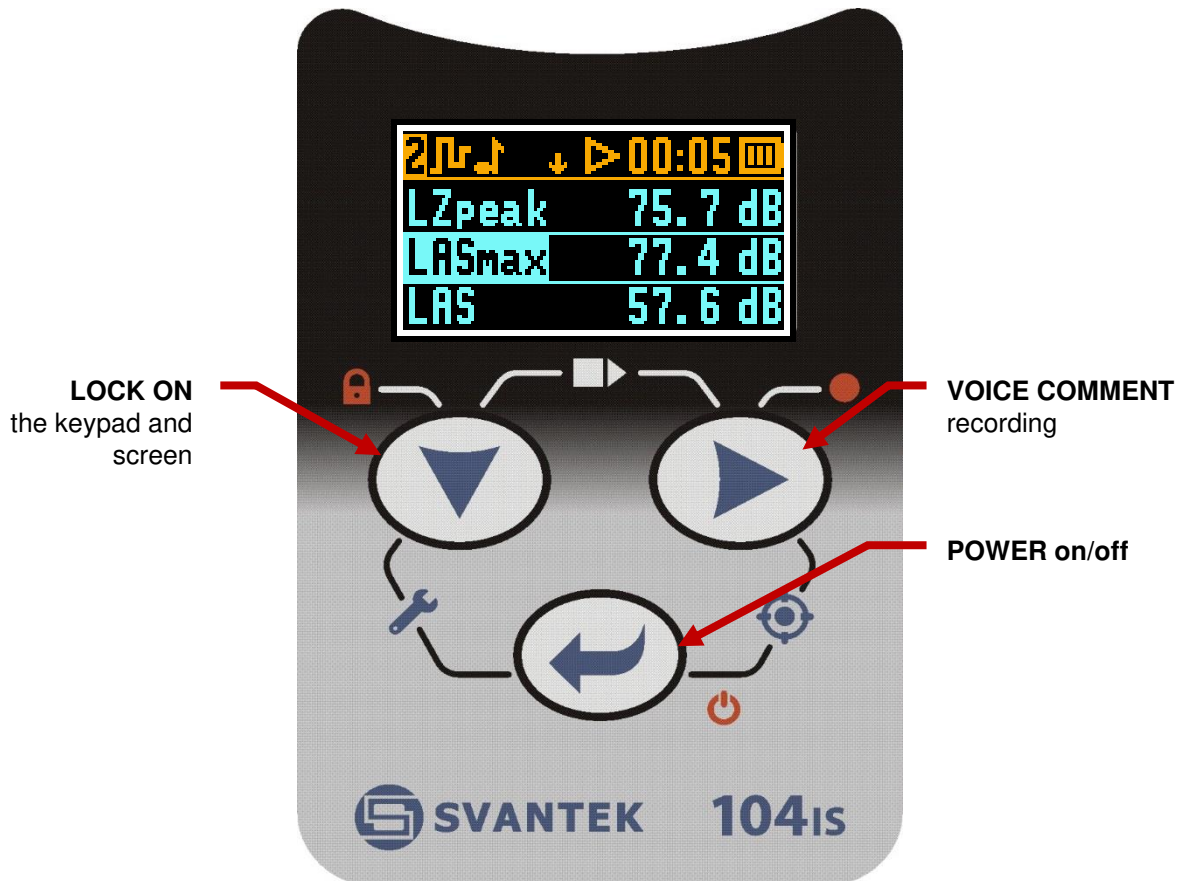





Figure 3-9 Control keypad on the front panel – alternate key functions

Holding down individual key for few seconds during which a countdown is displayed, SV 104BIS gives you time to decide if you really wish to access the function that is going to be executed:

- Shutting down 3... 2... 1... for the  key
- Keyboard lock 3... 2... 1... for the  key
- Voice comment 3... 2... 1... for the  key.

If you release the key too early, SV 104BIS returns to the last used **VIEW** mode and the selected control is not executed.

3.8.3 Alternate combined keys functions

Additionally, **combined short press of two keys simultaneously** (keypad icons marked with white colour) allow quick access to even more functionalities.

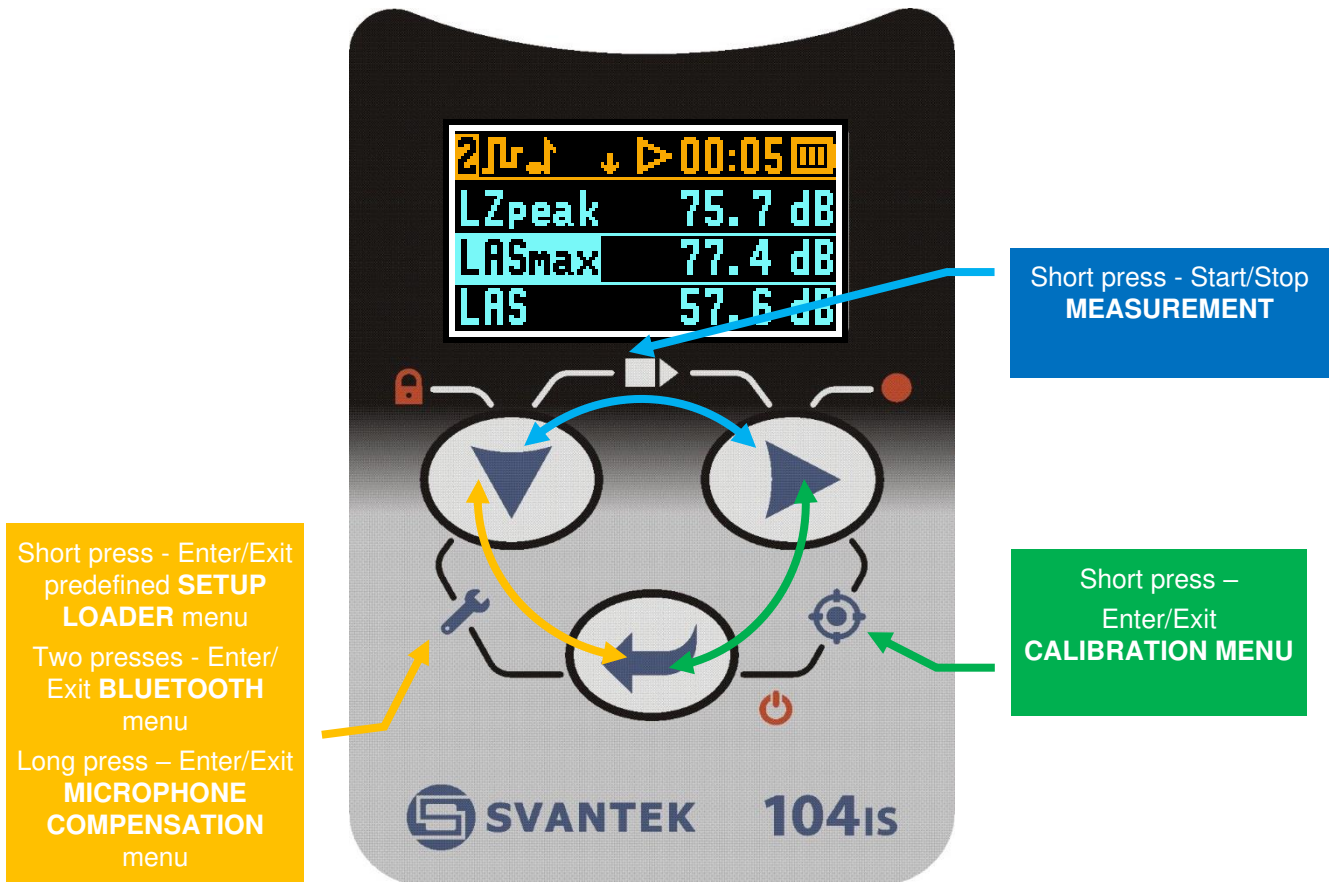




Figure 3-10 Control keypad on the front panel – alternate combined keys function





Note: Extra additional keypad functionality is also available to display the instrument's **Unit Label** screen showing the current firmware revision number. It is accessible by a **short press of all three keys at once**.



Note: Press the  and  keys simultaneously **twice** to access Bluetooth menu.



Note: Microphone compensation settings are accessible by holding down the  and  keys simultaneously for three seconds.

Warning: Changing microphone compensation filter setting is not recommended for purposes other than laboratory calibration!

3.9 THREE INSTRUMENTS IN ONE – ACOUSTIC PROFILE CONCEPT

SV 104BIS is able to monitor and log noise by enabling up to three different parameter configuration settings, also referred to as “**ACOUSTIC PROFILE**”. One can set profile no 1 to run measurements using the OSHA HC (Occupational Safety and Health Administration - Hearing Conversation) parameters and at the same time set profile no 2 to monitor the noise with the OSHA PEL (Occupational Safety and Health Administration – Permissible Exposure Level) parameters while profile no 3 is set to ACGIH parameters. This is the true triple instrument in one.

3.10 THE VIEW MODE PRESENTATION CONCEPT

Such an advanced noise dosimeter as SV 104BIS offers a large number of parameters for the operator to inspect. Therefore, all information is divided in a neatly organized manner as **VIEW** modes for each PROFILE.

The **VIEW** mode is a way in which the measurement parameters are presented to the operator. In other words, when you change the VIEW mode, specific measurement parameters and status information will be presented in different manner as distinct screen content.

SV 104BIS features the following VIEW modes, where most of them can be individually disabled:

- Running instantaneous SPL view mode (Chapter [3.10.1](#)) - *can be disabled with PC software*
- Primary “one-result” parameters view mode (Chapter [3.10.2](#)) - *cannot be disabled*
- Results list view mode (Chapter [3.10.3](#)) - *can be disabled with PC software*
- 1/1-octave analysis spectrum LEQ view mode (Chapter [3.10.4](#)) - *can be disabled with PC software*
- 1/1-octave analysis spectrum MAX view mode (Chapter [3.10.4](#)) - *can be disabled with PC software*
- 1/3-octave analysis spectrum LEQ view mode (Chapter [3.10.5](#)) - *can be disabled with PC software*
- 1/3-octave analysis spectrum MAX view mode (Chapter [3.10.5](#)) - *can be disabled with PC software*
- Instrument Status view mode (Chapter [3.10.6](#)) - *can be disabled with PC software*



3.10.1 Running SPL view mode

The Running SPL view mode is used when measurement run is not actually running, that is when the instrument is in standby mode before or after a measurement. In this mode the current SPL result is calculated and displayed, but not stored in the instrument's memory. The purpose of this information is to give the user a first indication of the sound levels about to be measured. This can be useful for some measurements. The instrument behaves as a simple general-purpose sound pressure level meter in this view mode.



Figure 3-11 Running SPL view mode screen

3.10.2 Primary “ONE RESULT” view mode

The One Result view mode is always available in all measurement modes and cannot be disabled. In the one result mode, any measurement result, selected with the  key, may be presented. The user may change the actual profile view by pressing the  key. This view mode is useful if in low vision conditions or is suitable for operators with some visual impairment.

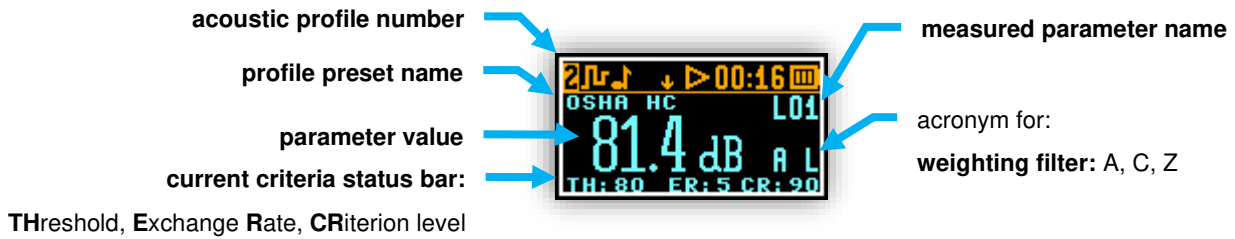


Figure 3-12 Primary ONE RESULT view

3.10.3 RESULTS LIST view mode


To get information about a number of results at one time it is handy to switch to the “results list” view mode. Up to three parameters at a time are accessible for the operator. In this view the user can scroll the list of results starting from the profile name and configuration with the  key.



Figure 3-13 RESULTS LIST view

3.10.4 1/1-octave analysis spectrum view mode



Note: The 1/1-octave analysis is switched on with the use of the Supervisor software – see Chapter [6.3.5](#).





Note: The 1/1-octave analysis is an optional function and should be activated before use. Activation of the optional functions can be made with the use of the Supervisor software – see Chapter [6.2](#).

The instrument operates as a real time 1/1-octave band analyser (RTA). In addition, and if enabled, 1/1-octave analysis is performed in parallel with the dosimeter operations. All 1/1-octave digital pass-band filters (with 9 centre frequencies from 8 kHz down to 31.5 Hz; in base 10 system) are working in real-time with the broadband frequency weighting filters (Z, A or C) and the linear LEQ detector. This enables the user to pre-weight a spectrum with one of the selected broadband frequency curves if required for a particular application such as the provision of hearing protectors in the control of high workplace noise levels.



Note: The three overall TOTAL LEQ results are measured with the weighting filters (A, C, Z) without taking into account the settings of the level meters for profiles. The spectra are always linearly averaged. Thus, the TOTAL values from 1/1 octave band analysis can be different from those obtained for the profiles (if the LEQ Integration was set as Exponential).

The results of 1/1-octave analysis (so-called spectrum) can be examined by the user on a display in the **Spectrum VIEW** presentation mode. 1/1-octave spectra for all 9 centre frequencies of pass-band filters together with the 3 TOTAL overall values measured with the user selected frequency weighting filters are presented in the Spectrum mode, if enabled in the configuration setup. Spectrum cursor can be moved left and right with the  and  keys respectively.

With the use of the **Supervisor** software, the user can select which spectrum (**LEQ**, **MAX** or both) will be available for view (Chapter [6.3.7](#)).

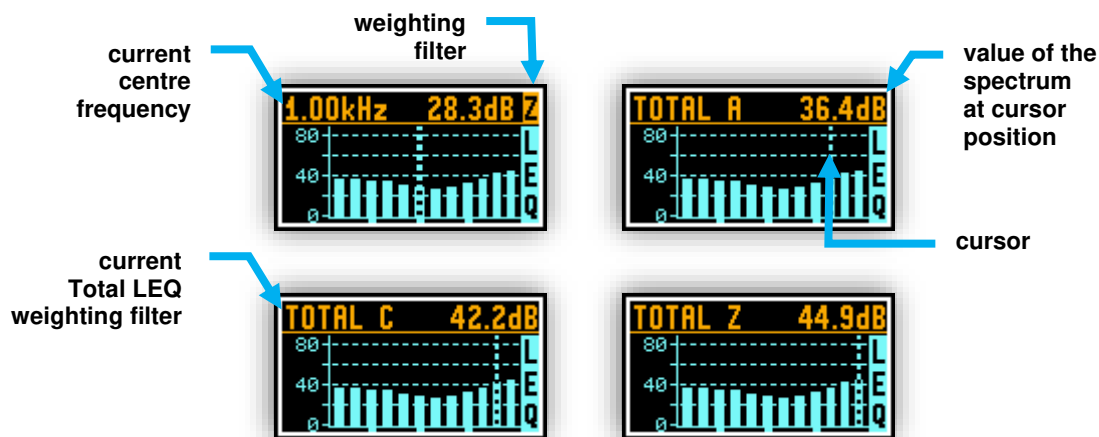


Figure 3-14 1/1-octave analysis LEQ spectrum graph view

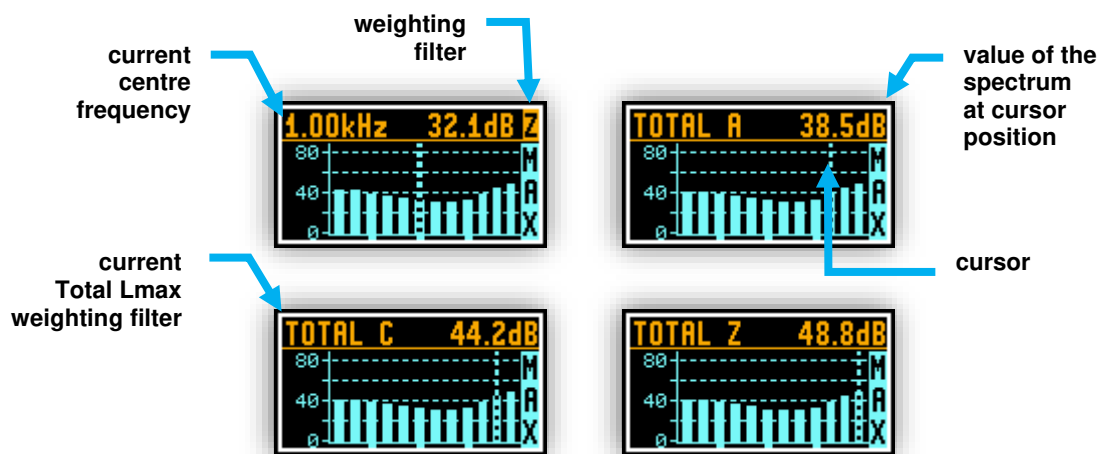


Figure 3-15 1/1-octave analysis MAX spectrum plot view

3.10.5 1/3-octave analysis spectrum view mode



Note: The 1/3-octave analysis is switched on with the use of the Supervisor software – see Chapter [6.3.5](#).





Note: The 1/3-octave analysis is an optional function and should be activated before use. Activation of the optional functions can be made with the use of the Supervisor software – see Chapter [6.2](#).

The instrument can also operate as a real time 1/3-octave band analyser (RTA). In addition, and if enabled, 1/3-octave analysis is performed in parallel with the dosimeter operations. All 1/3-octave digital pass-band filters (with 28 centre frequencies from 10 kHz down to 20 Hz; in base 10 system) are working in real-time with the broadband frequency weighting filters (Z, A or C) and the linear LEQ detector. This enables the user to pre-weight a spectrum with one of the selected broadband frequency curves if required for a particular application such as the provision of hearing protectors in the control of high workplace noise levels.



Note: The three overall TOTAL LEQ results are measured with the weighting filters (A, C, Z) without taking into account the settings of the level meters for profiles. The spectra are always linearly averaged. Thus, the TOTAL values from 1/3-octave band analysis can be different from those obtained for the profiles (if the LEQ Integration was set as Exponential).

The results of 1/3-octave analysis (so-called spectrum) can be examined by the user on a display in **Spectrum VIEW** presentation mode. 1/3-octave spectra for all 28 centre frequencies of pass-band filters together with the 3 TOTAL overall values measured with the user selected frequency weighting filters are presented in the Spectrum mode, if enabled in the configuration setup. Spectrum cursor can be moved left and right with the  and  keys respectively.

With the use of the **Supervisor** software, the user can select which spectrum (**LEQ**, **MAX** or both) will be available for view (Chapter [6.3.7](#)).

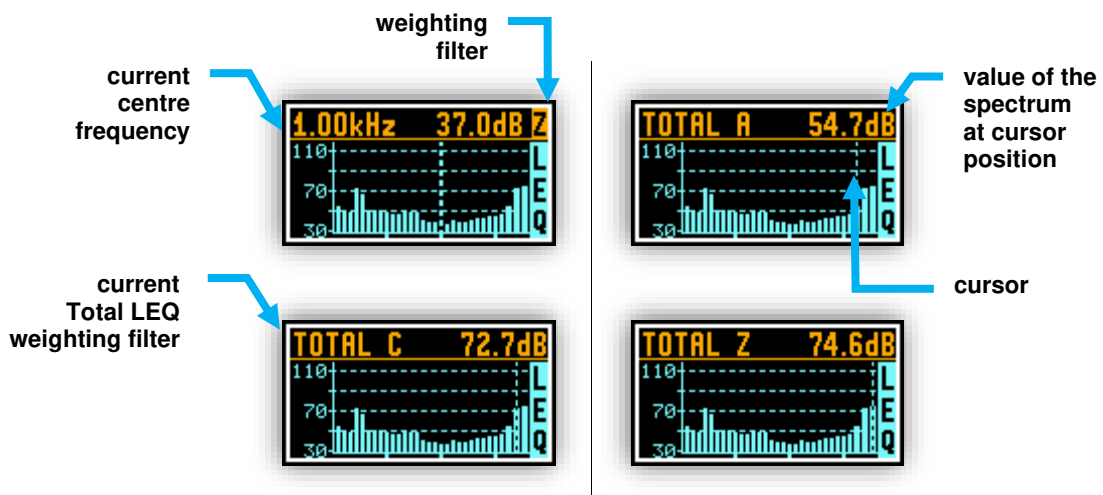


Figure 3-16 1/3-octave analysis LEQ spectrum plot view

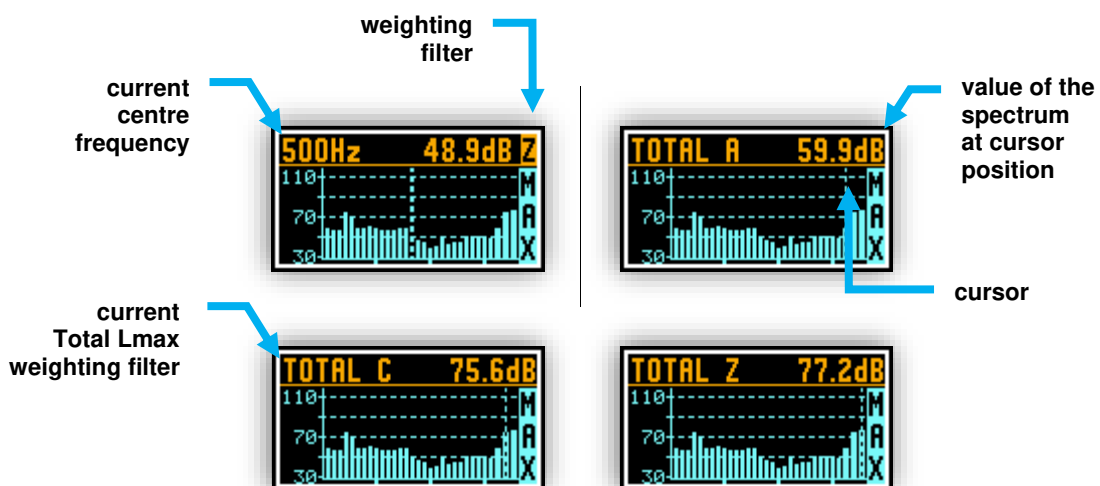


Figure 3-17 1/3-octave analysis MAX spectrum plot view

3.10.6 INSTRUMENT STATUS view mode and Bluetooth security PIN code

The Instrument Status view presents:

- the battery charge status (**Bat.Charge**) along with estimated working time which is left until the battery is expected to be completely drained (**Bat.Left**)
- current configuration information (**Setup**),
- Bluetooth status (**On** or **Off**) and PIN code,
- Timer status (**On** or **Off**) and time left to start.

The Instrument Status screen is moved down and up with the  and  keys respectively.

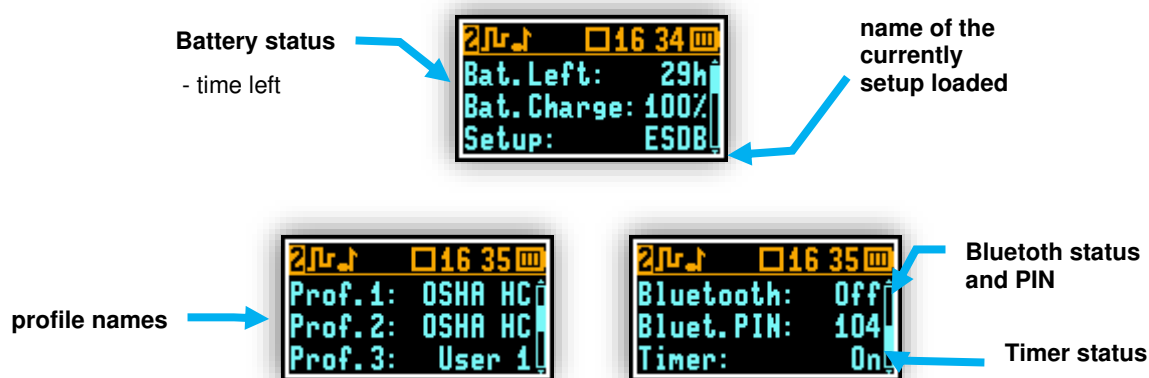


Figure 3-18 INSTRUMENT STATUS view mode screens

The Bluetooth security PIN enables the user to protect the instrument's access via Bluetooth® by **Assistant** mobile application. PIN is defined in the Supervisor software (Chapter [6.5.7.4](#)).

When **Timer** is **On** there are additional positions in the Status list with time left to start.



Figure 3-19 Timer information

3.11 ALARM SCREEN REVIEW

Apart from simple LED alarm indications (Chapter [3.6](#)) there are a few alarm conditions when ALARM presentation screens will appear. During a measurement run SV 104BIS will immediately turn on the display at the time that the programmable alarm condition is exceeded. The detailed alarm state condition for each profile is presented to the user. Press any key, to confirm the information.

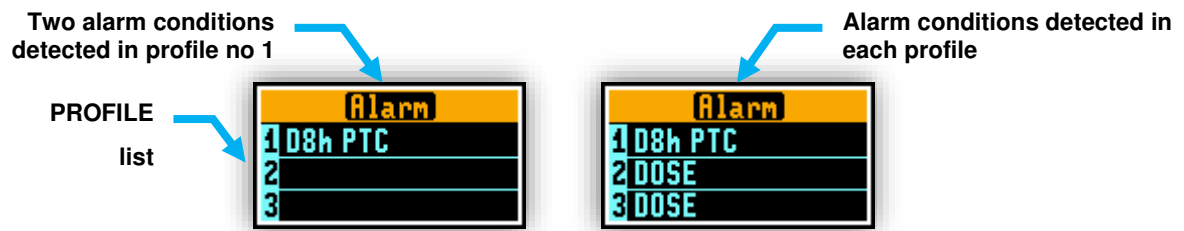


Figure 3-20 ALARM view screens



Note: At any time when battery power is almost exhausted the “low battery” alarm screen may inform you about immediate recharging requirement.

4 RUNNING AND OPERATING BASIC PROCEDURES

4.1 CHARGING SV 104BIS

SV 104BIS can be charged only with the use of docking station for a single unit (1-bay docking station **SB 104B-1**) or for five units (5-bays docking station **SB 104B-5**).

Both docking stations are equipped with the USB Type B connector and can be connected with a PC for data transfer with the **SC 16** cable. SB 104B-1 is also powered via the USB port whilst SB 104B-5 is powered by the **SB 33** power supply (9V AC/DC).



Figure 4-1 1-bay and 5-bay docking station (SB 104B-1 and SB 104B-5)

To charge SV 104BIS place it onto the docking station charger and ensure the power cable is connected. SV 104BIS will automatically turn on the display during charging and present how much charge is within the instrument. SV 104BIS will display 'Charging completed' once charging is completed. This should take approximately 7 hours from a fully discharged state. A charging time of about 2 hours will be sufficient to perform greater than 10 hours of measurement. A fully charged instrument holds enough charge to run for approximately 45 hours.

Note that once disconnected from the docking station, the dosimeter will automatically switch off. If put again onto the docking station the internal battery is float charged. This keeps the battery performance in steady condition. If the battery is fully discharged prior to being placed on a charger, it trickles charges for a maximum 1h time prior to the fast charge cycle, this prevents damage to the batteries.

Docking stations are equipped with the LED. Table below describes LED statuses of the Docking Station.

Charger LED status indication		Description
SB 104B-1	OFF	Dock station is not powered on
	GREEN	Indicates the dock station is powered on and fully operational
	RED	Dock station is powered on, but not fully operational
	RED flashing quickly, 2 times per second	Charging error – ambient air temperature limit exceeded
SB 104B-5 <i>LED on the top</i>	OFF	Dock station is not powered on
	GREEN	Indicates the dock station is powered on and fully operational
	RED	Dock station is powered on, but not fully operational
SB 104B-5 <i>LED on the side</i>	RED flashing quickly, 2 times per second	Charging error – ambient air temperature limit exceeded

Table 4-1 Docking station LED status description

When the dosimeter is on the docking station, its LED shows its charging status.

LED status indication	Description
GREEN continuous	Dosimeter is charged.
RED continuous	Dosimeter is charging.
RED flashing quickly, 2 times per second	Charging error - temperature limits inside the dosimeter exceeded.
Not lit	Not charging but not charged (communication is on) <i>If so, probably the battery may be damaged or unusable, because charger IC in dosimeter has time limiter and turns off LED when charging is impossible.</i>

Table 4-2 LED status description of the SV 104BIS when dosimeter is on the Docking Station



Note: The battery inside SV 104BIS uses lithium-ion technology which requires special consideration and handling techniques due to the extremely high energy density (see “SPECIAL PRECAUTIONS WHEN USING AND CHARGING LITHIUM BATTERIES” clause on page 5). Ensure the SV 104BIS is fully charged prior to use by installing it(them) at the Dock Station.



Note: Charging is allowed only in safe area. See the SPECIAL PRECAUTIONS WHEN USING AND CHARGING LITHIUM BATTERIES clause on page 5.



Note: To charge a fully discharged battery, it would take approximately 8 hours.



Note: To charge dosimeters with the use of SB 104B-5, it is necessary to use 9V AC/DC power supply such as the SB 33 to provide enough current performance. USB connection doesn't ensure enough power to charge dosimeter(s) with the use of SB 104B-5.

4.2 BEFORE YOU TURN THE INSTRUMENT ON

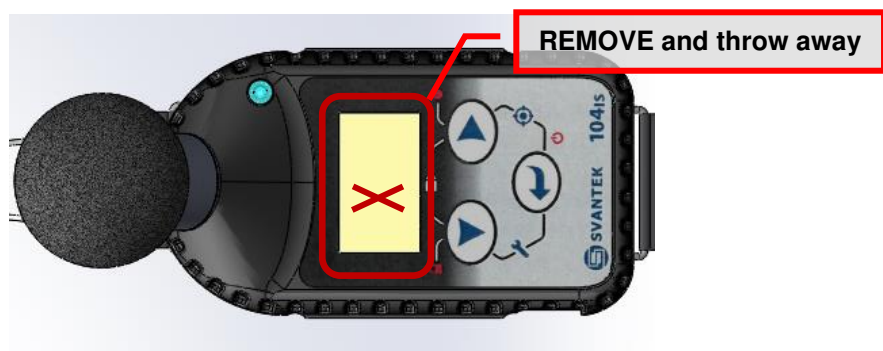
There are only a few things to remember:

- Make sure the microphone is properly fastened onto mounting head before turning on the instrument.
- When in use for a measurement run, always use the SA 122BIS windscreen provided.




Note: On new products there is a display shipping protection foil which is used on new products being sent to protect from accidental scratches. It is ~25x15mm foil rectangle.

Peel off the protection foil and throw away.



4.3 TURNING ON/OFF

TURNING ON: To switch the power on the operator should hold the  key for a couple of seconds. The instrument switches on and goes the self-test routine (during this time the manufacturer's logo, the name of the instrument and firmware version is displayed).

If testing is successful SV 104BIS will run through a short start-up sequence, showing the current configuration setup loaded along with the names of all of three profiles, followed by battery state screen. After this, the instrument will enter the stopped (ready to measure) mode and enter the running SPL mode if it was enabled.




Note: Warm up time - After power on, the instrument should be warmed up for at least 30 seconds before starting measurement.



Note: If you leave the instrument in stopped (ready to measure) mode, the display will be switched off after 30 seconds, and the unit will turn off after approximately 5 minutes of no keypad activity to save the batteries.



Note: SV 104BIS will show a warning screen if the battery capacity is below 2 hours of potential measurement time.

TURNING OFF: To shut down the instrument the operator should hold the  key for a couple of seconds during which a countdown ("Shutting down" 3... 2... 1...) is displayed. Thus, SV 104BIS gives you time to decide if you really want to turn off the instrument. If you release the key too early, SV 104BIS returns to the last presented **VIEW** mode.

If enabled in the configuration setup there may be presented an additional, double-check, warning screen. This is for the operator to be aware and convinced the instrument is really to be turned off. See figure below:

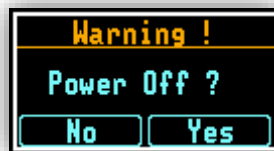


Figure 4-2 Power-off warning screen




Note: SV 104BIS will automatically shut down after 5 minutes in the stopped mode.



Note: If **auto-run** (timer) mode is active, SV 104BIS will automatically stop the measurement when the set time is over and then turn off. If no **auto-run** mode is used and specific time has not been preset, the unit will continue to measure until the battery is exhausted. Just before switching off, the measurement run will be stopped and all data until that point will be saved securely for later download to the PC.

4.4 BATTERY CHECK

Observe the battery icon in the instrument's icon status bar or press the  key until the Instrument Status view mode is presented and check the battery state. If it is too low, charge the batteries (Chapter [4.1](#)).

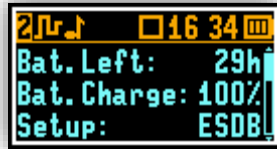





Figure 4-3 Instrument Status - Battery state

Battery status screen is moved down and up with the  and  keys.

Press  to change to the next **VIEW** mode.



Note: Battery state of charge calculation is based on internal charge counter and should be considered only as an overall, not very precise estimation. Therefore, the time left could be noticeably different. Although the newest technology cells are used the slight degradation over time is inevitable thus aging requires occasionally factory based (or authorised service centre) replacement of the rechargeable battery cells.






Note: Battery power indicator - To improve accuracy of remaining battery life indicator, run the dosimeter until it is fully discharged; then proceed with a full charge via docking station. The procedure is recommended before first use. Repeat this procedure every few months of use to maintain more accurate current battery condition indication.

4.5 REVIEWING UNIT LABEL

Unit label screen provides information about elementary dosimeter properties such as:

- Copyrighted manufacturer name: **SVANTEK (C)**
- Instrument name: **SV 104BIS**
- Unit serial number: **SN XXXXX**
- ST 104B microphone serial number: **SN ST104B XXXXX**
- Unit name: **XXXXXXXX** [user programmable name]
- Firmware version: **Version X.XX.X**
- File system version: **FS Version X.XX**
- CRC value: **CRC(OK) XXXX**
- Standards list, that the dosimeter conforms to:
 - **IEC 61252:2020**
 - **ANSI S1.25:1991 (R2017)**
 - **Class 2: IEC 61672-1:2013**
 - **Class 1: IEC 61260-1:2014**

To access the **Unit Label** screen short press altogether three keys: ,  and  at the same time.

The following screen will be presented:

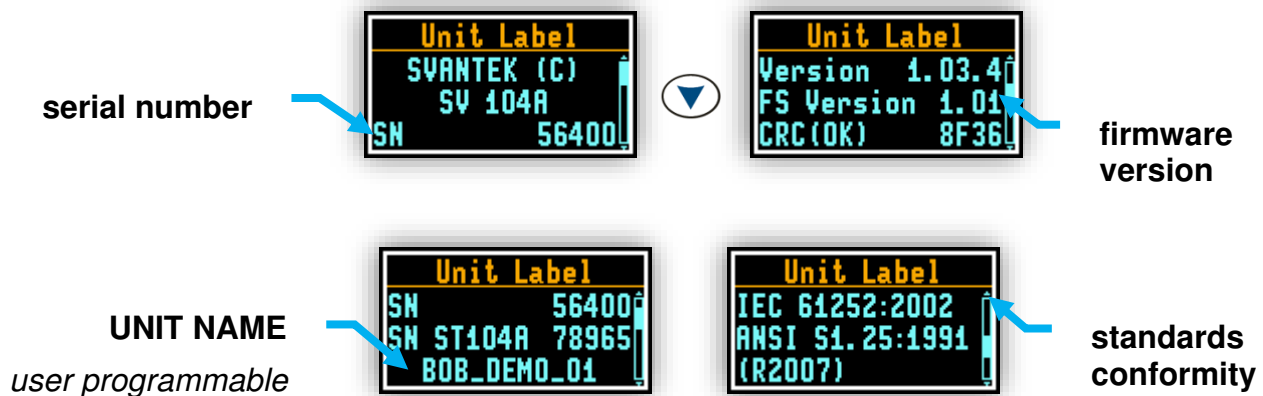




Figure 4-4 Unit label screens

Unit label screen is moved with the  or  keys.

To exit the Unit Label screen just shortly press the  key. Then SV 104BIS will return to the last presented **VIEW** mode.



Note: The personalized **Unit Name** can be set arbitrarily with **Supervisor** software.

4.6 MEASUREMENT SETUP - BASIC CONFIGURATION

Press two keys  and  at the same time. The **Load Setup** menu will appear with the list of loaded configuration setups to choose.

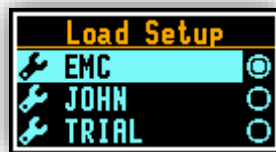


Figure 4-5 Load setup menu

To abandon setup selection, press again  and  at the same time. Otherwise select the required configuration setup with the  key navigating thru the list with the  or  key.

The following screen will appear, that will allow you to confirm you really want to load the selected setup or cancel the selection and return to configuration setup list:

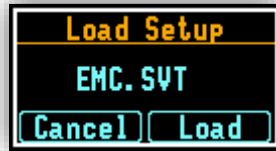




Figure 4-6 Load setup confirmation

Press the  key to cancel the setup loading, or the  key to confirm loading selected setup configuration. Confirming the loading of configuration setup leads to the screen with status of the loading procedure:

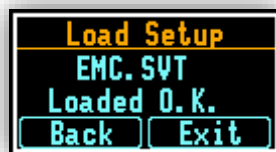




Figure 4-7 Status of setup loading

After successfully setup loading it is possible to return back to the list of predefined setups by pressing the  key or go further to the measurement screen by pressing the  key.



Note: Detailed description of uploading setup files onto SV 104BIS can be found in Chapter [7.6](#) of this manual.

4.7 CALIBRATION

The SV 104BIS dosimeter is offered with the dedicated **ST 104B** MEMS microphone with ½" housing. The instrument is factory calibrated with the supplied microphone for the standard environmental conditions. Because the microphone sensitivity is a function of the temperature, ambient pressure and humidity, the absolute calibration of the measurement channel should be performed locally.


Svantek offers the **SV 34B** sound calibrator 114dB@1000Hz for the SV 104BIS instruments.



Note: Calibration with use of SV 34B is allowed only in a safe area.

The instrument has an automatic calibration function, which can be enabled or disabled with the use of the Supervisor software (see Chapter [6.3.9.1](#)). One of the important instrument settings is the sound pressure level generated by the calibrator. By default, the automatic calibration is enabled, and the calibrator signal level is set to 114 dB.

If the automatic calibration is enabled the instrument performs the acoustic calibration automatically, when the calibrator is placed over the microphone (first remove the windscreen). The calibrator level is automatically detected, and the calibration procedure is started.

The user simply has to press the  key to confirm the calibration results. Calibration is only allowed in the stopped mode. A sound measurement cannot be in progress while the calibration is being performed.



Note: It is advised to perform an acoustic calibration of the instrument each time before and after the measurement run. A single calibration at the start of each day of use is usually sufficient for most regulations.



Note: The calibration factor is always added to the results in the Dosimeter or 1/1-octave or 1/3-octave analyses modes.



Note: The manufacturer's recommended factory calibration interval is every 12 months for this instrument to be confident in its continuing accuracy and compliance with the international specifications. Please contact your local SVANTEK distributor for further details.

To calibrate the instrument manually the user has to enter the **Calibration** menu.

1. Adjust the actual calibration level of the calibrator to be used with the  and >  keys.

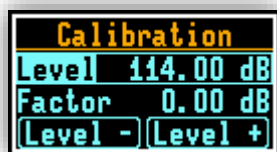





Figure 4-8 Calibration menu

2. Attach the acoustic calibrator **SV 34B** (or equivalent 114dB@1000Hz) carefully yet tightly over the microphone of the instrument.



Note: It is also possible to use an electro-mechanical pistonphone, which generates the signal (ca 124 dB) or different type of acoustic calibrator dedicated for 1/2" microphones with an alternative output level such as 94 dB at 1 kHz. In any case, before starting the calibration measurement, the user has to set the level of the signal generated by the given calibrator (Level position), which is stated in the calibration certificate of the unit (the default expected value of the Calibration Level set by the manufacturer of SV 104BIS is equal to 114 dB).

3. Switch on the calibrator and wait ca 30 seconds for the tone to stabilise before starting the calibration measurement.
4. Start the calibration measurement by pressing the  key.
5. The calibration measurement time is set to 1 second with 3 seconds' delay. Calibration stops when either 5 consecutive results will not differ from themselves by more than 0.02 dB or 10 consecutive results will not differ from themselves by more than 0.05 dB. It is possible to stop the calibration measurement by pressing two keys at the same time  and .

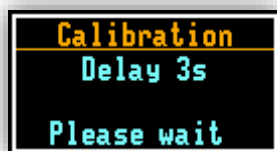


Figure 4-9 Calibration - initial delay screen

6. Delay before starting calibration measurement is counted down on the display. After the measurement, its result is presented on the display.

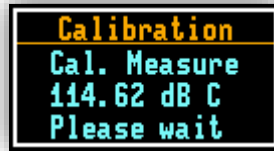
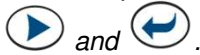


Figure 4-10 Calibration in progress screen




Note: To quit the calibration procedure without saving the calibration factor press at the same time



7. It is recommended to repeat the calibration measurement few times. The obtained results should be almost the same (with ± 0.1 dB difference). The reasons for the unstable results are as follows:
- the calibrator is not properly attached to the instrument
 - there are external acoustic disturbances such as high noise levels close by
 - the calibrator or the measurement channel (for example the microphone) is damaged.



Note: During the calibration measurement, the external disturbances (acoustic noise or vibrations) should not exceed a value of 100 dB (when using a calibrator that generates a level of 114 dB).

8. Press  to accept the measurement result.

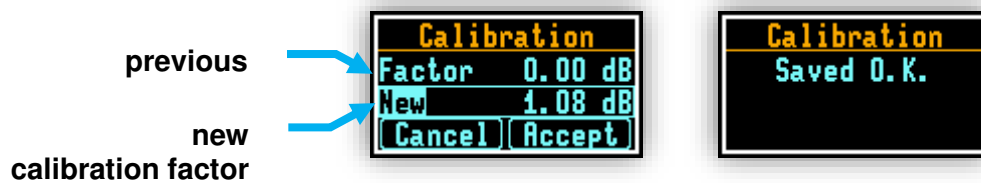


Figure 4-11 Calibration confirmation screen



Note: If a calibration factor does not meet tolerance criteria ± 2 dB, you still can manually accept the microphone, but the results could possibly be affected - see [Figure 4-12](#).

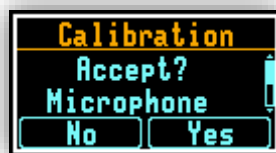



Figure 4-12 Calibration - microphone not in tolerance screen

9. Post calibration. If enabled remotely, the post processing is performed automatically under acceptance of the calibration measurement. SV 104BIS automatically adds the results to the previously saved files. Before saving the calibration factor, the text "**Post Calibration**" appears.

4.8 VOICE COMMENTS RECORDING

In order to record a comment, the user should press the  key for a few seconds during which a countdown ("Voice comment" 3... 2... 1...) is displayed. Thus, SV 104BIS gives you time to decide if you really want to record a voice comment. In case you release the key too early, SV 104BIS returns to the last used **VIEW** mode.

Entering the voice comment recording usually brings up a window with a question to which logger file the voice comment is to be linked - to the previous or to the next one. NOTE: This window will be skipped if there are no previous logger files or the unit is just turned on.

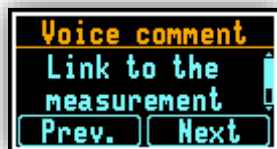




Figure 4-13 Voice comment linking screen

After selecting an answer by pressing the  or the  key the record command window will open.

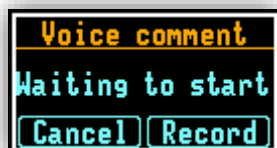


Figure 4-14 Voice comment recording command screen


After starting the recording with the  key flashing circle that indicates recording in progress will appear on the screen.



Figure 4-15 Voice comment recording in progress screens


Further, one can continue to record a comment about the measurement and press the  key to finish recording. The recording end will be confirmed with the screen comment "Saved O.K.".



Figure 4-16 Voice comment record confirmation screen



Note: The voice comment can be recorded before or after the measurement run takes place and linked to the Previous or the Next measurement run. But be beware, that linking to the previous measurement will not be possible in case when the unit is switched off and on again or there are no previous logger files. In this case the recording screen will appear (with default linking the comment to the next logger file).

4.9 BEFORE AND AFTER MEASUREMENT RUN

Before starting a measurement ensure:



- 1 the instrument is turned on (Chapter [4.3](#))
- 2 there is sufficient battery operating life and free memory by checking the status screen (Chapter [3.10.6](#))
- 3 required configuration setup is selected (Chapter [4.6](#))
- 4 SV 104BIS is calibrated, because it affects the results (Chapter [4.7](#))
- 5 the windscreen is put on because it protects the microphone from industrial environment such as dust and moisture or from effects of impact (Chapter [3.3](#)).

After stopping the measurement run, make sure:

- 1 the calibration is still maintained (Chapter [4.7](#))
- 2 the data is properly downloaded to PC for further analysis (Chapter [4.16](#))
- 3 the instrument is turned off (Chapter [4.3](#)).

4.10 STARTING AND STOPPING MEASUREMENT RUN

START:

To start measurements the user has to press the  and  keys at the same time. The results of the measurement are displayed in the last used result's display view mode. As an example, ONE RESULT view mode is displayed. ONE RESULT view mode is always available for most functions of the instrument. The results of the measurements can also be presented in other view modes, which can be enabled or disabled and adjusted to the user's needs.

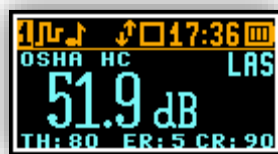




Figure 4-17 One profile mode screen view

STOP:

The same combination of keys:  and  allows the user to stop the measurement run. All run results are always saved automatically, there is no need to save them manually.



Note: The instrument can be started or stopped remotely thru wireless Bluetooth® interface. See Chapter [5](#) for mobile application description.

4.11 AUTO-RUN MODE INFORMATION


Note, that when auto-run mode (timer and/or pause) is configured, there is information on the screen available for the user. There is no need to turn on the instrument manually. All the timer procedures can be easily pre-programmed with the use of the **Supervisor** software.



Figure 4-18 Auto-run mode – timer and programmable pause screen

4.12 SECURITY LOCK

Please consider locking the keypad and display during the measurement to prevent the wearer or anybody else from tampering with the measurement run. SV 104BIS can be set up to automatically go into locked mode when it starts (Chapter [6.3.9.3](#)). That automatically prevents any tampering, but the unit can still be unlocked, if necessary, with proper sequence of key presses.

Locking SV 104BIS: To lock the instrument the operator should hold the  key for a couple of seconds during which a countdown (“Keyboard lock” 3... 2... 1...) is displayed and the unit gives you time to decide if you really want to activate security lock. If you release the key too early, SV 104BIS returns to the last presented **VIEW** mode.

Unlocking SV 104BIS: To unlock the instrument the operator should press the keys in the correct sequence. The sequence is pre-programmed in the configuration setup (Chapter [6.3.9.3](#)).



Figure 4-19 Unlocking the unit sequence screens






Note: The instrument is automatically unlocked when it is placed on the docking station.

4.13 REVIEWING MEASUREMENTS

Most of the parameters can be inspected in real-time during either measurement run or stopped mode of operation. If the display screen is turned off just press any key (but watch notice below).

The keys on the keypad of the instrument enable you to navigate thru most of the parameters. For specific information on the **VIEW** modes, see Chapter [3.10](#).

- Use the  key to move down the list through the various measurements.
- Use the  key to change the ACOUSTIC PROFILE you would like to inspect.

- Use the  key to change the VIEW mode.



Note: In most cases the keypad will be probably locked. To gain access to the results and unlock the keypad see Chapter [4.12](#).



Note: After reviewing results remember to lock the keypad again in order to maintain the integrity of the measurement run by preventing uncontrolled access to the instrument.

4.14 CONTROL OF THE INSTRUMENT VIA BLUETOOTH® WIRELESS INTERFACE

The Long-Range Bluetooth® Low Energy wireless connectivity and the supporting **Assistant** mobile application enables remote control and monitoring of the instrument's status such as battery usage, memory capacity and measurement progress and results without having to disturb the worker. You can be sure, that confidence in the measurement minimizes the likelihood of having to repeat an examination due to potentially impaired data and therefore maximizes your performance. For more detailed description of the remote-control, see Chapter [5](#).



Note: After reviewing results remember to lock the keypad again in order to maintain the integrity of the measurement run by preventing uncontrolled access to the instrument.

The Bluetooth connection between the instrument and **Assistant** mobile application can be established after setting up the PIN code. PIN code is defined through the **Supervisor** software (see Chapter [6.3.9.4](#)).





By pressing the  and  keys simultaneously **twice** the user can enter the **Bluetooth** menu. Pressing the  key the user can turn the Bluetooth® on or off. Press  and **Accept** to confirm selection.



Figure 4-20 Switching the Bluetooth® on



Note: By default, **Bluetooth®** is disabled. For Air-transport **Bluetooth® should be disabled**. Make sure that correct settings file is applied or switch it off manually - see Chapter [3.8.3](#).

4.15 SWITCHING OFF MICROPHONE COMPENSATION

The ST 104B microphone is digitally compensated. In addition to it the free filed and the SA 122BIS windscreen effects are compensated with the Free Field compensation filter. By default, both compensations are active.

For laboratory approval testing or calibration measurements it is necessary to disable one or both compensation filters (see Appendix C).





To access the **Microphone** menu, press the  and  keys simultaneously and keep them pressed for 3 seconds. Pressing the  key the user can switch on or off the compensation. Press  and **Accept** to confirm selection.



Figure 4-21 Disabling the Free Field filter

4.16 DATA DOWNLOADING AND UPLOADING

Downloading and uploading data can be done with the use of docking stations and the **Supervisor** software (see Chapter 6.4.1).

The docking stations exchange data with a PC by the USB protocol.


Both docking stations are equipped with the USB-B plug and require the **SC 16** cable.



Figure 4-22 USB connections of the SB 104B-1 and SB 104B-5 docking station

In the case data transmission is failed, docking stations should be reset. To reset the docking station, disconnect all cables from the docking station to cut off the power.

4.17 RESETTING DOSIMETER

- **FACTORY SETTINGS:** clears any setup configuration and brings back the default factory settings. You can reset the factory settings with the use of the **Send 'clear setup' command** if you click right mouse button at the instrument row of the Supervisor's Inventory panel (Chapter 6.2).
- **HARDWARE RESET:** internal hardware reset; the setup configuration is not changed. Hold down the  key for about 30 seconds and then release it. If the instrument was switched on, the screen will shut down after approx. 20 seconds. Turn on the instrument as usually (Chapter 4.3).



Note: Hardware reset is only to be used in extreme situations such as an instrument hang-up. Be aware, that a hardware reset:

- will stop any pre-programmed auto-run modes
- will stop measurement run
- **HARDWARE RESET works, even if the keyboard becomes locked out!**

5 ASSISTANT MOBILE APPLICATION

Assistant is an application for mobile devices (smartphones and tablets) running on Android platform (5.0 or higher) and iOS platform (9.0 or higher) that extends functionalities of SV 104BIS. The application uses the Bluetooth® interface enabling current results to be previewed on a mobile device as well as controlling the measurement Start / Stop.

Assistant also signals an alarm when the certain limits are exceeded. The unique feature of the application is functionality of sending an email or SMS on pre-programmed alarm conditions.

The Assistant application supports also other Svantek instruments (e.g., SV 100A vibration whole-body dosimeter, SV 971A and SV 973 sound level meters).

5.1 INSTALLING ASSISTANT ON A MOBILE DEVICE

To install Assistant on your mobile device:

1. Download the Assistant installation file from the svantek.com website to your mobile device - smartphone / tablet with Android 5.0+ or iOS 9.0+ systems.

You can also download *Assistant* from the *Play Store* application.

2. Go to the folder on your mobile device with the downloaded installation file *assistant_x.x.x.apk*, tap it and follow installation procedure.

To start working with Assistant, select its icon in your device and tap it.



Figure 5-1 Assistant welcome screen

Assistant may ask you to enable Bluetooth® and Localization services on your smartphone or tablet. Assistant will detect visible instruments automatically.

5.2 CONNECTION VIA BLUETOOTH®

Assistant compatible instruments with enabled Bluetooth® will broadcast their basic status and some basic data will be visible on a mobile device running the application.

Instruments with Bluetooth® interface enabled and powered off are also detected and displayed. If some instruments are switched off, they appear on the instrument list with the comment “Turned off”. You may switch them on by clicking on the instrument’s bar.

If an instrument is protected by the PIN code you will be asked to enter this code in a special screen, otherwise *Assistant* will not be able to download data from the instrument.

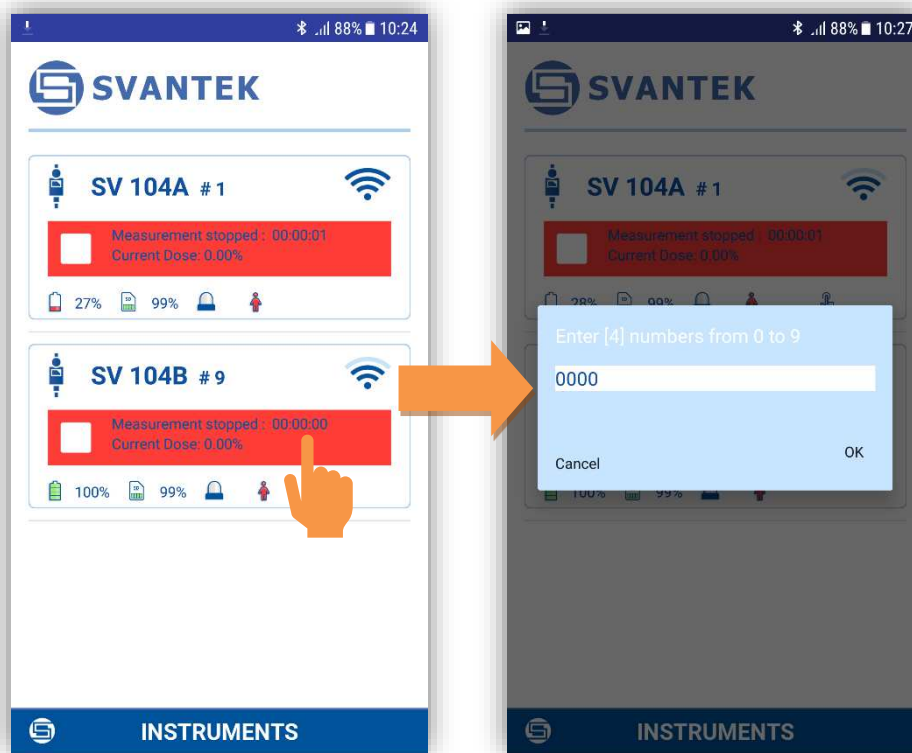


Figure 5-2 Assistant scanning/status screen



Note: You will not get access to the instruments that are under control of other simultaneously running **Assistant** applications on another mobile device.



Note: It is recommended that SV 104BIS is in the locked mode to discourage the wearer from tampering and is described in Chapter [4.12](#).

5.3 CONTROL VIA BLUETOOTH®

The Assistant application has two main screens: scanning/status screen and result view/control screen.

Tapping the fields inside the instrument frame you can go to the instrument's results view and measurement control screen.

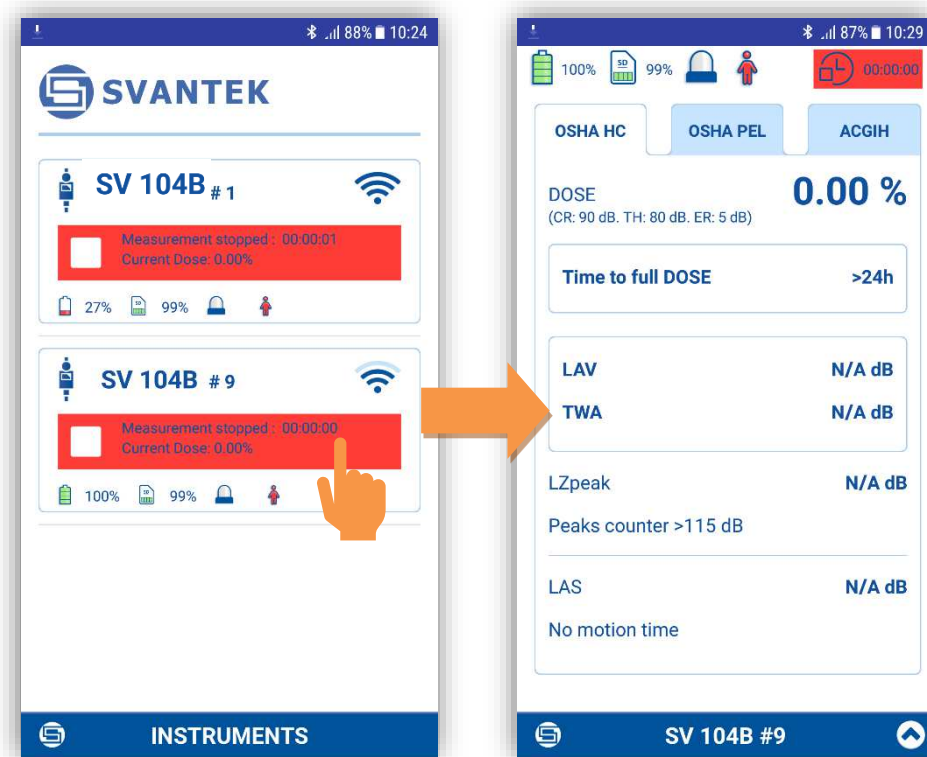


Figure 5-3 Changing main view screens

If you wish to come back to the scanning/status screen just press the “Exit” button on your mobile device.

5.3.1 Instruments' status screen

In the scanning/status screen you may observe the state of a set of instruments.

Each instrument status is displayed in the frame that contain up to three fields. First field displays the instrument name and serial number. Instrument's unique name can be defined via Assistant and also via the Supervisor software (Chapter 6.2). Second field shows the instrument status (**Turned off**) or if it is turned on – the measurement status. If the measurement is stopped the field is red, if in progress it is green, if in pause – yellow.

The third field contains several icons that inform you about:



93%

Internal **battery** status of the selected instrument. The battery capacity is displayed in percentage. If battery is close to be empty its colour changes to red.



99%

Internal **memory** status of the selected instrument. The green area and the percentage display the empty memory capacity.



Dose **alarm**. If dose is above the threshold level the icon is red and the mobile device starts to vibrate.



Movement of the controlled person. If the controlled person is moving the icon is green, otherwise the icon is red.



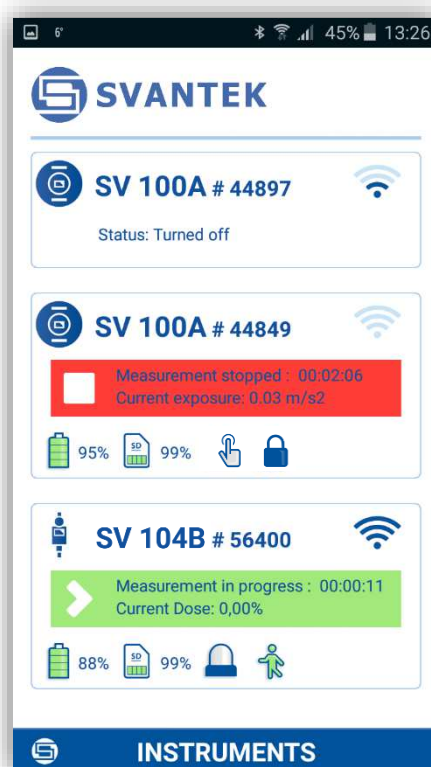
Someone is using the instrument's **keyboard**.



Lockout status because of other current device control over this instrument.

As an example:

- The instrument SV 100A #44897 is switched off.
- The instrument SV 100A #44897 is switched on and measurement is stopped. Battery charging is 95%, free memory is 99%, no alarm, the controlled person is not driving a vehicle.
- The instrument SV 104B #56400 is switched on and measurement is running. Current Dose value is displayed. The controlled person presses the instrument's button, and this instrument is already controlled by another mobile device. Note, that since scanning there may be a few seconds' delay.



5.3.2 Results view / control screen

The result view/control screen enables you viewing measured results of the particular instrument and controlling the measurement.

From this screen, you can **Pause**, **Start** or **Stop** a measurement run tapping the appropriate icon on the measurement control bar. Stopping the measurement run requires confirmation.

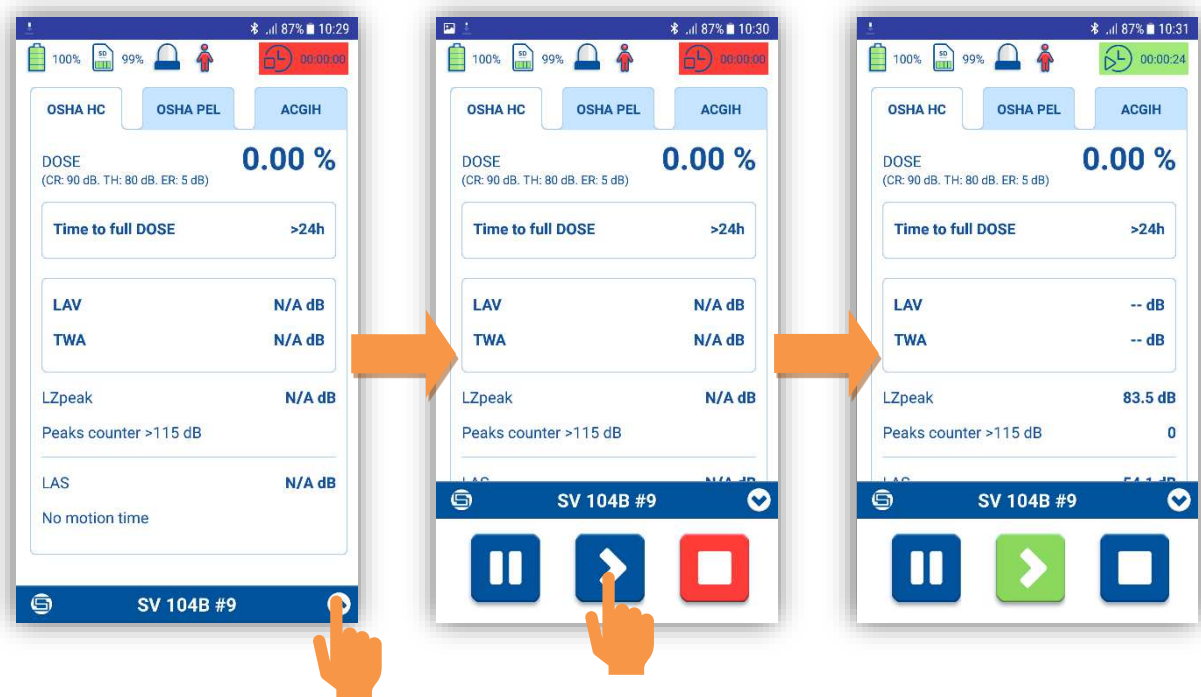
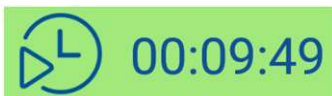


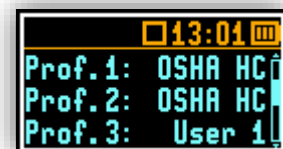
Figure 5-4 Assistant results review and pause/start/stop screen

As in the scanning/status screen the same icons in the upper screen line describe the instrument status. In addition to them, the integration time is displayed.



Integration time. If the measurement is in progress, the field turns green and time shows the elapsed measurement time. If the measurement is stopped or paused, the field turns red or yellow, and the time change will be stopped.

You can also navigate thru the **acoustic profiles** (Chapter 3.9) by pressing certain tab at the top of the screen with profile's names, defined in the setup.



You can change the **Time to full DOSE** parameter within **Assistant** application by pressing its bar on the screen.

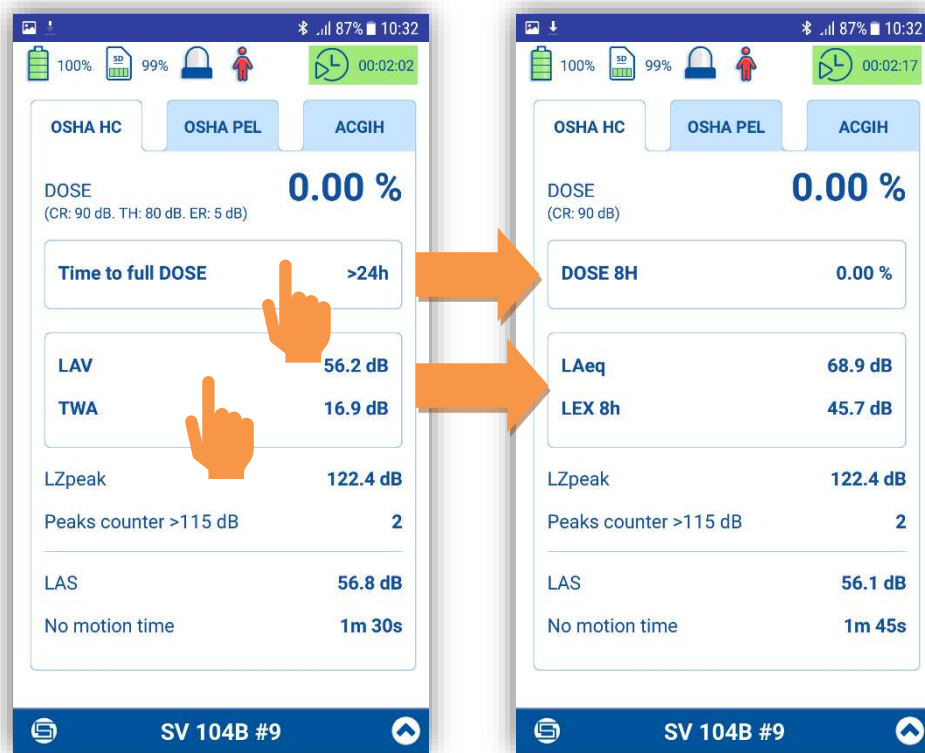

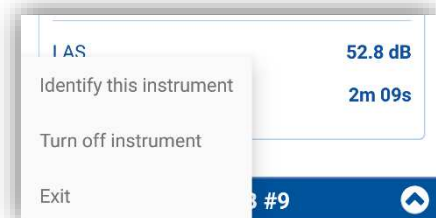


Figure 5-5 Changing of results to be viewed

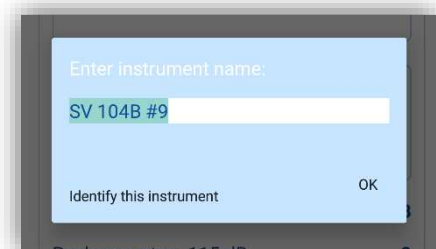
After pressing the  button, the pop-up menu appears in which you can:

- Identify corresponded instrument.
- Turn the instrument off.
- Exit the application.



After tapping the **Identify this instrument** position, the pop-up box with the current name of the corresponded instrument will appear. If you tap "Identify this instrument", the instrument shows its name which will blink for 5 seconds then the instrument returns to the previous screen.


At the same time, you can change the name of this instrument.



5.3.3 SMS and e-mail notifications

Assistant can also send e-mail / SMS messages directly from the application or send automatic SMS notifications based on pre-programmed alarm conditions. Alarm conditions are set in the **Supervisor** software and uploaded as **setup** configuration files (Chapters: [4.6](#) and [6.3](#)).

The notification is sent when the specified alarm limit is exceeded.

The recipient and contents of the E-mail or SMS is defined by tapping the  button, and then selecting the appropriate command from the pop-up menu.

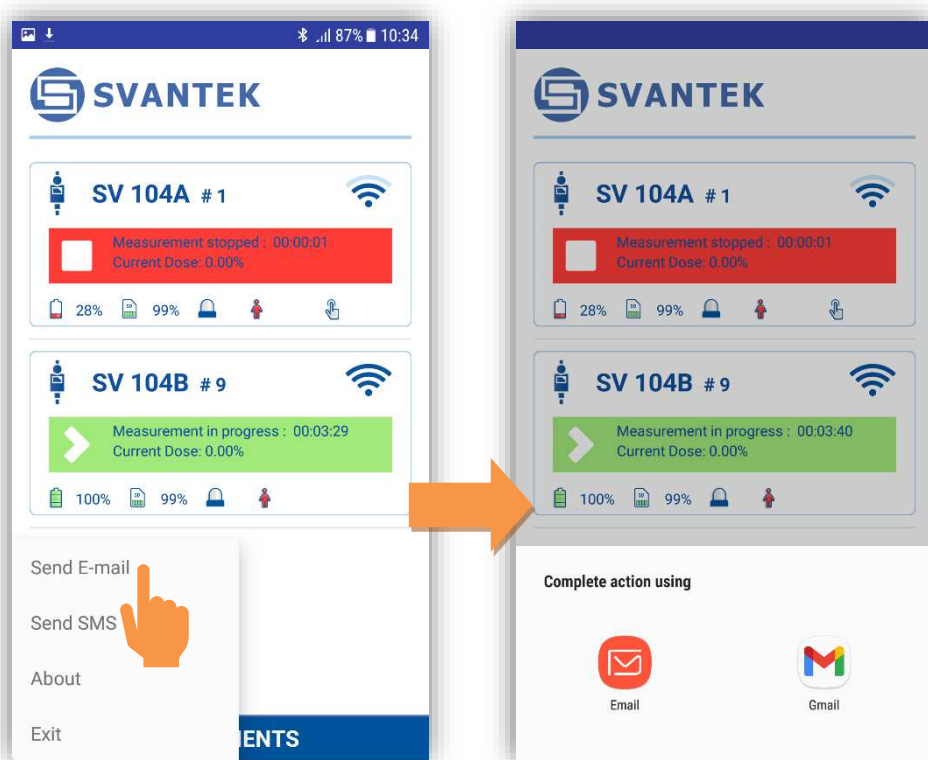


Figure 5-6 Sending e-mail

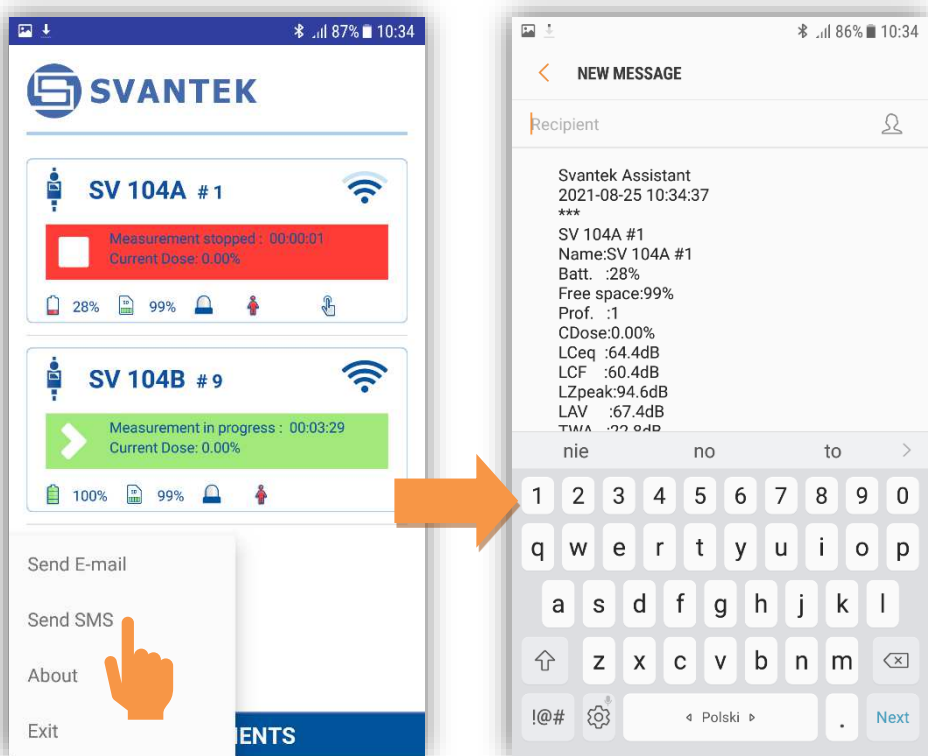



Figure 5-7 Sending SMS

5.4 CHECKING THE SOFTWARE VERSION AND EXITING THE APPLICATION

To check the software version, tap the  button in the lower left corner and select the **About** command.

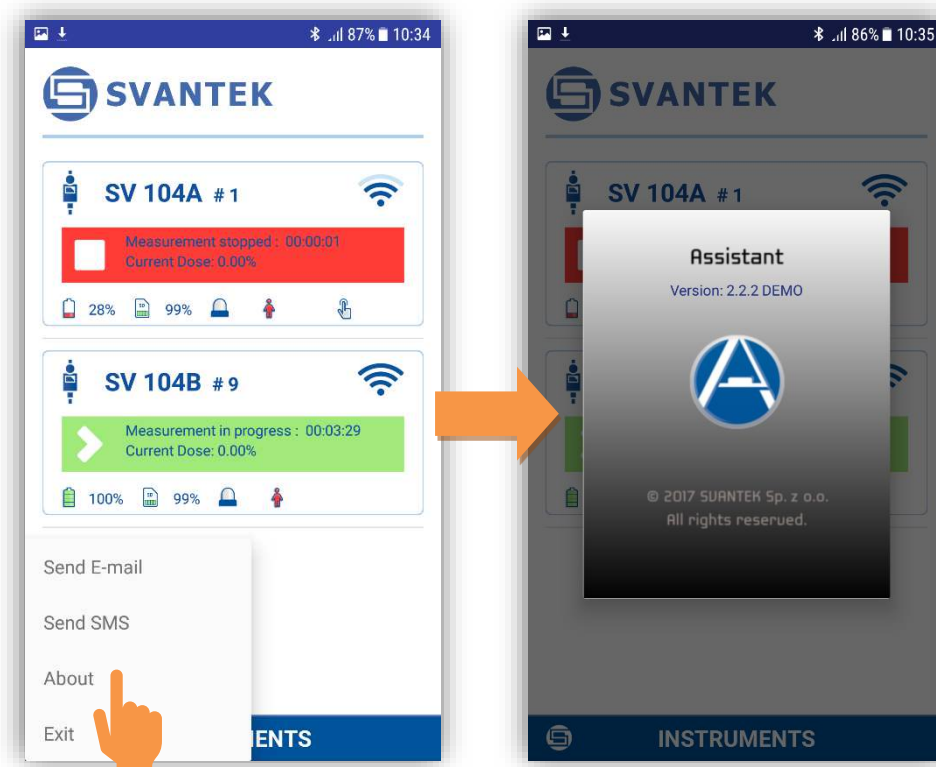



Figure 5-8 Checking the Assistant version

To exit the application, tap the  icon in the lower left corner and select the **Exit** command.

6 SUPERVISOR BASIC OPERATIONS

This chapter explains how to download data and configure dosimeter settings as well as analyse data and prepare reports with the **Supervisor** software.

Supervisor can be used in two modes - *Advanced* or *Lite*. *Supervisor Lite* is recommended for Health and Safety professionals who are just starting to work with the program. This manual gives an overview of the basic features of the Lite option. Both program options are widely described in Supervisor User Manual.

6.1 INSTALLING AND CONNECTING

Download the **Supervisor** installation file to your PC and run the installation program. The USB drivers are integrated with the installation file and you do not have to download them yourself from the website.

After installation, you are ready to connect the SV 104BIS dosimeter.


- Plug the **SC 16** USB-B cable into the **SB 104B-1** or **SB 104B-5** docking station.
Note: The **SB 104B-5** docking station should be powered with the **SB 33** power supply.
- Plug the opposite side of the USB cable into the computer.
- SV 104BIS is powered and charged directly through the docking station. Once enough charged, the dosimeter screen will be switched on automatically with current charging information only.
- Turn on the dosimeter – long press of the  key.
- Once switched on, run the **Supervisor** software and choose its mode – Advanced or Lite.



Figure 6-1 Choosing the Supervisor mode

You can also switch between the modes when Supervisor is running by clicking the Svantek icon and clicking in the opened menu **Run as Supervisor Advanced** or **Run as Supervisor Lite**.



Note: This User Manual describes the basic features of the **Supervisor Lite** mode and most important operations with the SV 104BIS instruments, like: instrument configuration, data download and report generation. To have full description of the Supervisor software, follow Supervisor User Manual.

6.2 SUPERVISOR MAIN WINDOW

The **Supervisor** main window is divided into few panels. Panels expose areas of interest of professional users and satisfy user's needs to find, configure, download, review and assess stored data in a very simple but professional way.

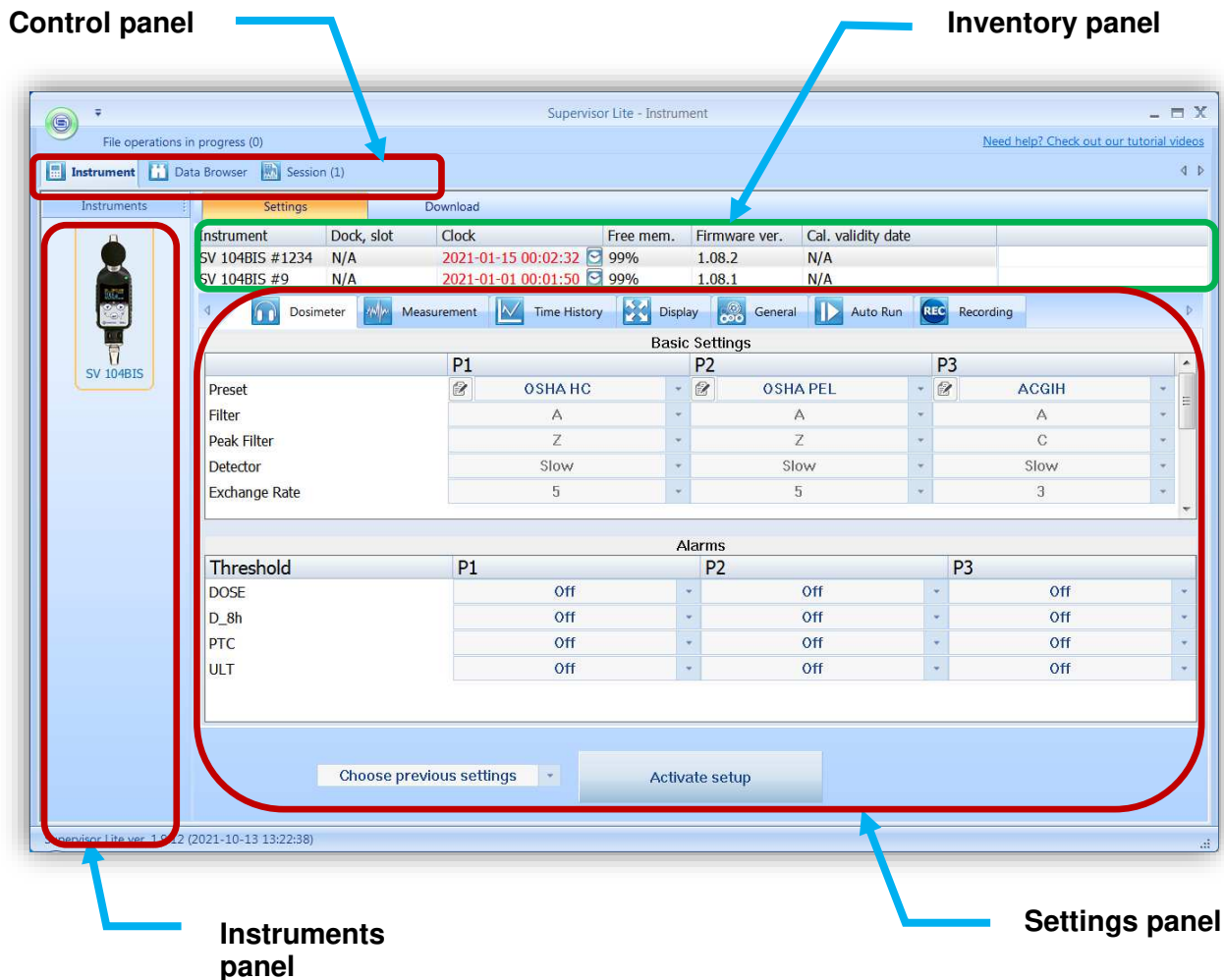


Figure 6-2 Supervisor main window


When a connected Svantek instrument is detected by Supervisor, it is added to the *Instruments* panel. The currently selected instrument is in the orange frame. The instrument information is presented in the *Inventory* panel.

Settings and *Download* tabs relate to the selected instrument type. If you click the instrument in the *Instruments* panel the program automatically downloads the setup file from this instrument and shows its settings in the *Settings* panel. At the same time the program downloads the list of instrument files and shows it in the *Download* panel.

If you have more than one instrument of the same type, the *Inventory* panel will be extended to present credentials of all these instruments. The *Settings* panel will present the setup of the first connected instrument and the *Download* panel will present the list of files of all connected instruments.

The *Inventory* table contain information about the Svantek instruments:

- *Name* – the instrument's name.

- *Clock* – the date and time set in the real-time clock of the Svantek instrument; you can adjust it to match the PC's date and time by pressing the  button. You can also right-click on the row corresponding to the selected instrument in order to open a context menu, allowing to specify the date and time manually.
- *Free memory* – the amount of free space on the instrument's SD card in percent. This option is available only for selected types of Svantek instruments.
- *Firmware version* – the version number of firmware installed on the instrument.
- *Last setup upload date* – the date and time when the last setup file was uploaded from Supervisor to the Svantek instrument.
- *Last uploaded setup name* – the name of the last setup file uploaded from Supervisor to the Svantek instrument.
- *Last setup activation date* – the date and time when the last setup file was activated (applied) in the Svantek instrument using Supervisor.
- *Last activated setup name* – the name of the last setup file activated (applied) in the Svantek instrument using Supervisor.
- *Instrument calibration certificate* – the title of the calibration certificate.
- *Calibration validity date* – date of calibration certificate's validity.
- *Calibrator Serial Number* – serial number of the instrument's calibrator.
- *Instrument Calibration Report* and *Calibrator Calibration Report*.

You can customize the Inventory table by clicking right mouse button on it and selecting/deselecting appropriate positions in the pop-up menu.

The calibration validity date in the Inventory panel is coloured according to the time remaining until the validity period is exceeded. By default, the colours mean the following:

- Black means that there are at least 90 days left;
- Yellow means that there are at least 14, but less than 90 days left;
- Orange means that there are less than 14 days left;
- Red means that the calibration validity period is already exceeded.

Connected	Instrument	Cal. validity date
No	SV 104BIS #64	2021-11-03
No	SV 104BIS #40	2021-01-01

Figure 6-3 Calibration validity date is coloured according to the proximity of the expiration date

In case of the SV 104BIS instruments connected to a PC via the SB 104B-5 Docking Station, an additional column is displayed, showing the serial number (number after #) of the Docking Station and the number of the slot occupied by each SV 104BIS instrument, as illustrated in the figure below.



Settings		Download	
Instrument	Dock, slot	Clock	Firmware ver.
SV 104BIS #8	#3500, 4	08/07/2021 10:26:40 	1.08.1
SV 104BIS #4	#3500, 1	08/07/2021 10:26:42 	1.08.1

Figure 6-4 Inventory panel view in case of SV 104BIS instruments connected via the SB 104B-5 Docking Station

The Inventory panel gives you more capabilities to manage the selected instrument, like: Refresh Catalogue, Set Clock, Edit name, etc.; if you click right mouse button on the instrument's row.

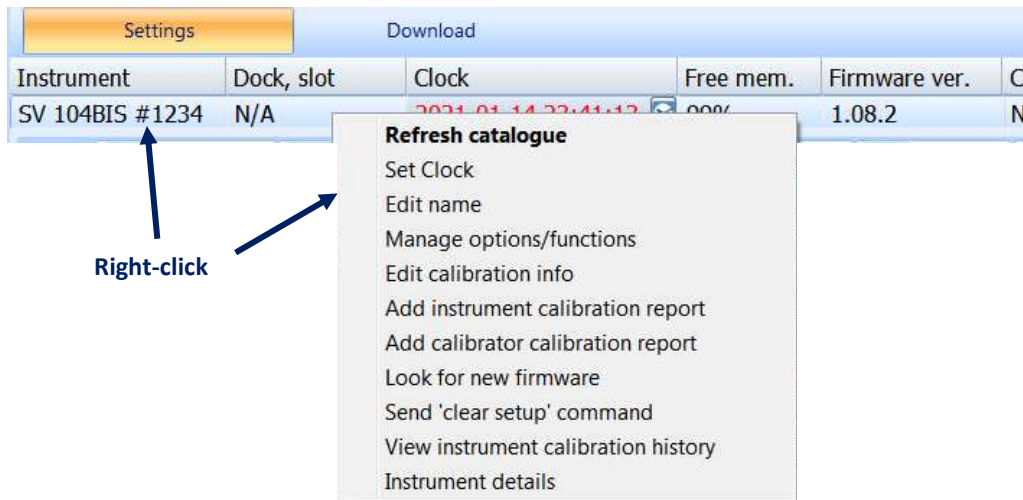


Figure 6-5 Inventory panel and its capabilities

The instrument's name can be specified using the *Edit name* command.

In order to unlock additional options or measurement functions of the SV 104BIS instrument that are available for purchase, use the *Manage options/functions* command in the instrument's context menu. When you click on this command, Supervisor downloads a list of available functionalities from the connected instrument and displays it in the form of two lists: one for options and one for measurement functions.

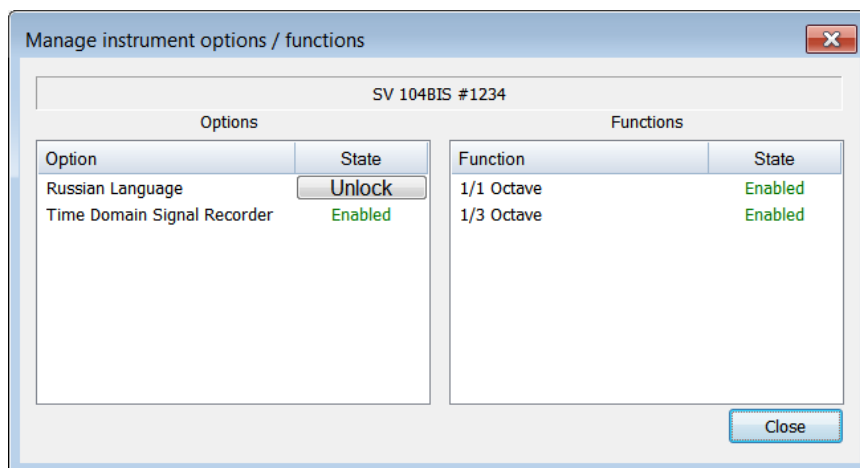


Figure 6-6 Manage instrument options / functions dialog box

The *State* column, located at the right-hand side of each option / function, contains the 'Enabled' label for unlocked options / functions, and the 'Unlock' button for the ones that have not yet been unlocked. If you wish to unlock an option or function that you purchased, press the 'Unlock' button and enter the unlocking code in the window that appears.

Note: If wrong code is entered three times since the instrument was last turned on, any later attempt to lock or unlock an option will fail (regardless on whether the entered code is correct or not) until the instrument is restarted.

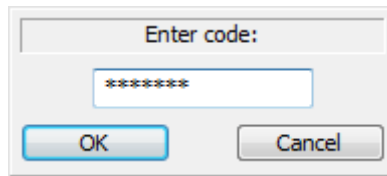


Figure 6-7 Entering code for unlocking an additional option or measurement function

You can also lock again an unlocked option / function by right-clicking on its name, selecting 'Lock' and entering the same code that was used for unlocking.

In order to search for the latest firmware for your instrument in the Internet, right-click on the instrument's line in the Inventory table and, in the context menu, select the *Look for new firmware* command.

6.3 EDITING THE INSTRUMENT'S SETTINGS

The *Settings* tool of Supervisor enables one to modify the instrument settings using the clear graphical interface and activate them on the connected instruments of the same type. In order to use the *Settings* tool, open the *Settings* tab in the *Instrument* window .

If you click the instrument in the *Instruments* panel the program automatically downloads the setup file from this instrument and shows its settings in the *Settings* panel.

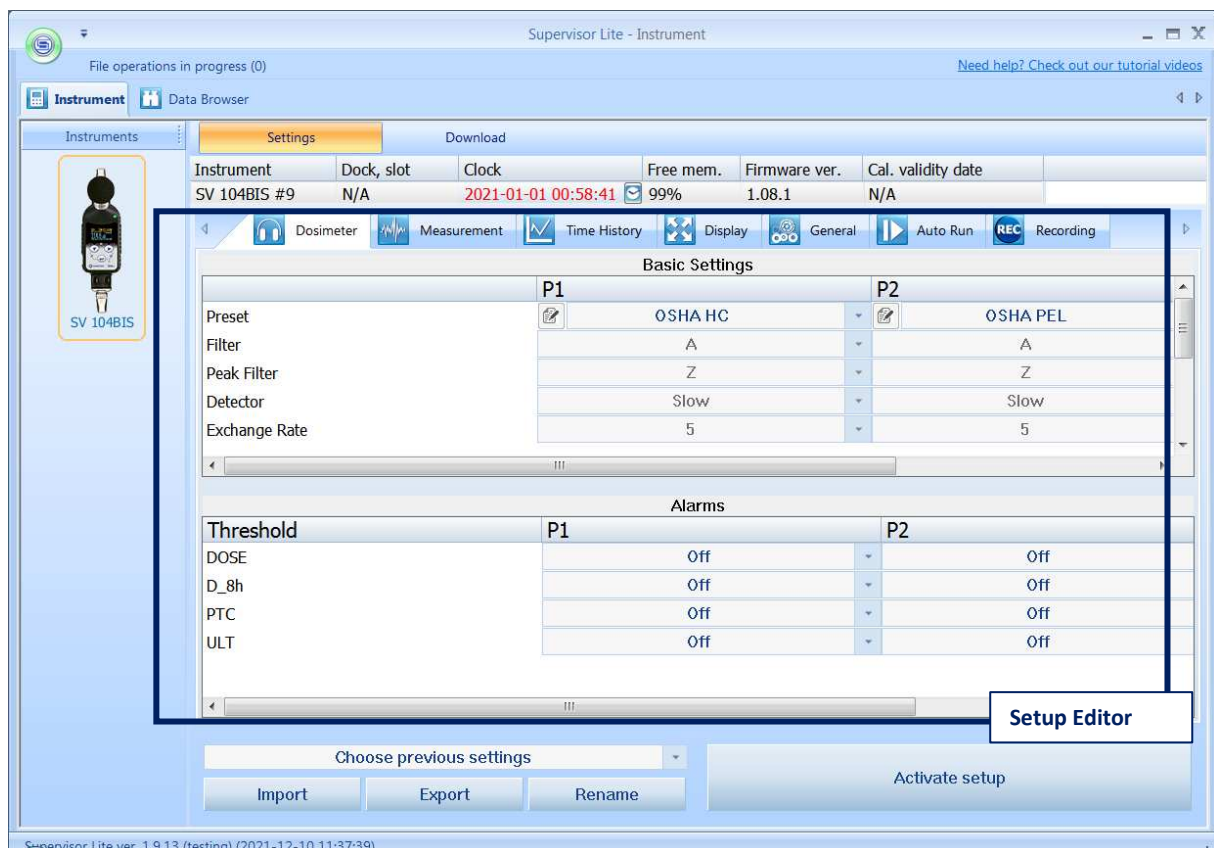


Figure 6-8 Using Supervisor to edit Svantek instruments' settings

Using the buttons below the Setup Editor, you can:

- choose up to ten previous settings that have been used most recently with this type of instrument,
- *Import* a setup file from a PC catalogue,
- *Export* current settings as a setup file to a PC catalogue,
- *Rename* previous settings.

6.3.1 Editing settings

The settings are divided into several categories, such as *General*, *Measurement*, *Spectrum*, etc. They can be accessed using the tabs located on the bar at the top of the Setup Editor panel. The availability of particular categories depends on the type of instrument the edited setup file is compatible with. In case there are too many categories to display all the tabs simultaneously, you can use the ◀ and ▶ buttons to scroll the bar.

The settings can be easily edited using the following elements of the Setup Editor's graphical interface:

- check boxes – allowing you to select some out of several possibilities,
- list boxes – allowing you to select one out of several possibilities,
- text fields – allowing you to specify a text value (e.g. a file name),
- binary buttons – allowing you to enable or disable an option.

In some cases, the 'Settings currently not available' message may appear, all settings in a particular category being unavailable for modification. It only occurs if the particular category of settings is triggered by enabling an option from another category in the same setup file. For example, the *Spectrum* settings will be available only if an analyser function (e.g. 1/1 Octave) is selected in the *Measurement* category of settings.



Figure 6-9 Example of a category of settings unavailable due to some other options in the same setup file being disabled

6.3.2 Applying settings

Changes that are made in setup files using the Setup editor are not automatically applied. To apply settings, you should press the *Activate setup* button.

After changing the settings, the *Activate setup* button changes its colour.

If you changed the settings for the one instrument type but haven't activated them, the program will warn you about this before leaving the Setup editor.

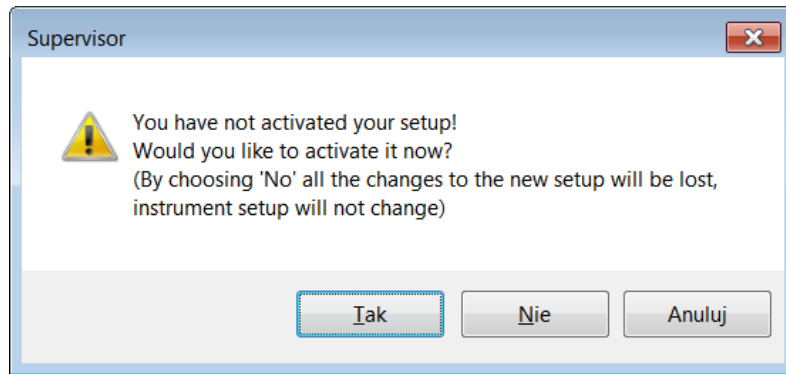


Figure 6-10 Warning that the setup was not activated

If you want to reinstall previous settings, press the *Choose previous settings* button and select the date of previous settings.

6.3.3 Using presets

The dosimetry profiles (available in the *Dosimeter* category of settings in the Setup editor) can be configured using so-called “presets”. A preset is a set of values of parameters related to the dosimetry profile, such as *e.g.* Filter or Detector. There are two types of presets: predefined and user defined. The six predefined presets are provided with Supervisor by default and are compliant with the following health and safety norms:


- OSHA HC – Occupational Safety and Health Administration Hearing Conservation,
- OSHA PEL – Occupational Safety and Health Administration Permissible Exposure Level,
- MSHA HC – Mine Safety and Health Administration Hearing Conservation,
- MSHA PEL – Mine Safety and Health Administration Permissible Exposure Level,
- ACGIH – American Conference of Governmental Industrial Hygienists,
- Nordic – standards specific for the Nordic countries.

Except of these predefined presets, you can create up to three user defined presets, consisting of custom parameters values.

Different presets can be selected for each profile independently. In order to configure one of the profiles according to a preset, use the *Preset* list-box. The first preset on the list, marked as [*Current*], represents the profile configuration currently saved in the edited setup file. It is provided so you can reset the changes you made in Setup editor by selecting it. If you make any changes in the *Current* preset, its name will be cleared (the currently selected preset will be named *None*).

When you select one of the predefined presets, the elements of the interface related to the parameters whose values are specified by the preset will be disabled. In order to change the values of those parameters, you need to select the current preset or a user-defined preset.

Note: Presets do not specify the values of all parameters; the parameters whose modification remains possible after selecting a predefined preset do not belong to the presets. These parameters are separated from the ones belonging to presets with a blank row.

You can create a user-defined preset by selecting one of the three last presets on the list and configuring the profile in a way you want it to be stored in the preset. The changes are automatically remembered by Supervisor. You can change the name of the preset using the  button.

Note: The three user-defined presets correspond only to the currently selected type of Svantek instrument. Different three presets are stored for each instrument type.

6.3.4 Profile settings

The main settings where specific acoustic profile configuration can be set are located under “Dosimeter” tab. There are already predefined pre-sets in each profile column. By choosing predefined configuration some obvious fields will be automatically greyed. Others must be setup by the user.

There are three additional user-defined pre-sets whose names can be changed during configuration with use of the little icon (notes with a pen) which is then enabled.

Apart from alarm **DOSE** threshold there are three additional source of warning alarm, which can be set. See figure below.

Basic Settings			
	P1	P2	P3
Preset	User 1	OSHA PEL	ACGIH
Filter	Z	A	
Peak Filter	A	Z	
Detector	Fast	Slow	Slow
Exchange Rate	2	5	3
Criterion Level	85dB	90dB	85dB
Threshold Level	75dB	90dB	80dB
ULT Threshold Level	115 dB	115 dB	115 dB

Alarms			
Threshold	P1	P2	P3
DOSE	Off	Off	Off
D_8h	Off	Off	Off
PTC	Off	Off	Off
ULT	Off	Off	Off

Figure 6-11 Dosimeter settings - profile configuration tab

Note: Some profiles can be disabled to be seen later during measurement run (Chapter [6.3.7](#)).

6.3.5 Measurement parameters settings

Within the measurement tab you can choose in which mode of operation the SV 104BIS should work: Dosimeter, or Dosimeter with 1/1-octave or 1/3-octave analysis.



Note: Enabling 1/1 or 1/3-octave analysis shortens battery life, so take it into consideration and double check the battery status before measurement run.

Other basic parameters configuration is shown on the figure below:

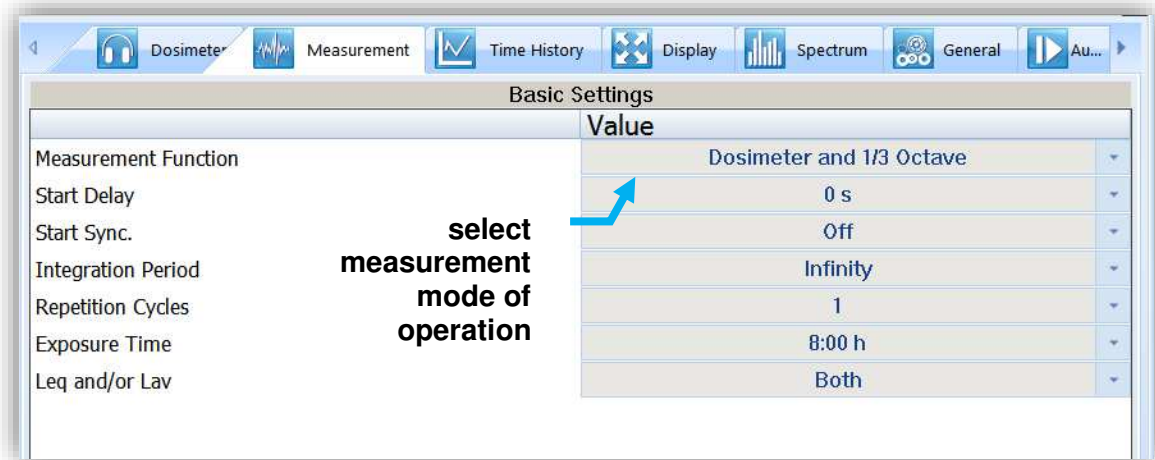


Figure 6-12 Measurement configuration settings tab

6.3.6 Time-history data logging settings

To enable logging the time-history data go to the “**Time History**” settings tab and switch the very first switch button on the left panel.

- In the **left panel** named “**Time History Setup**” there are basic configuration fields related to: how frequently do you want to log the parameters, what name the logger file should have, and if extended summary results should be saved.

Note: Summary results are saved on the “**Integration Period**” basis (not on “**Logger Step**” time).

- Right panel** named “**Profile Results**” is accessible only if the “**Logger**” switch button is set to “**On**”. You can choose, which basic results for each acoustic profile should be logged during measurement run and saved in the internal storage memory.

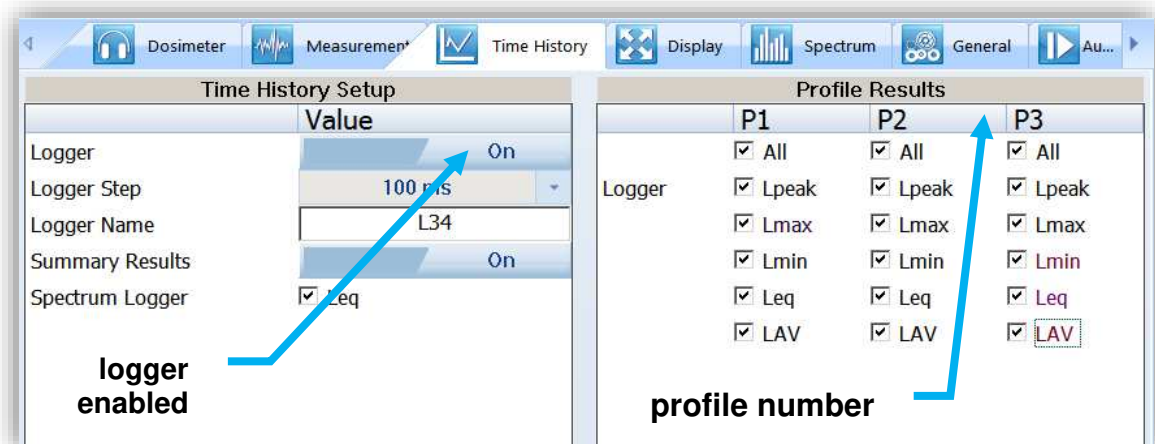



Figure 6-13 Time History (logger) settings tab


6.3.7 VIEW configuration

As mentioned in Chapter 3.10 there are quite a few VIEW modes accessible on the display, when the dosimeter is performing a measurement run.

- In the **left panel** named **“Modes & Views”** you can select which VIEW mode will be present when you press the  key on the dosimeter keypad.

Note: If you do not want to use all three ACOUSTIC PROFILES it would be convenient for you to enable only one acoustic PROFILE to be displayed – just select the required one.

Note: The “ONE-RESULT” (Chapter 3.10.2) is the only VIEW mode that is always present and cannot be disabled.

- In the **right panel** named **“Display Results”**, you will find a list of over a dozen measurement parameters, that can be configured to be presented on the SV 104BIS display, when you press  key. See Appendix D to review acronyms for each parameter.

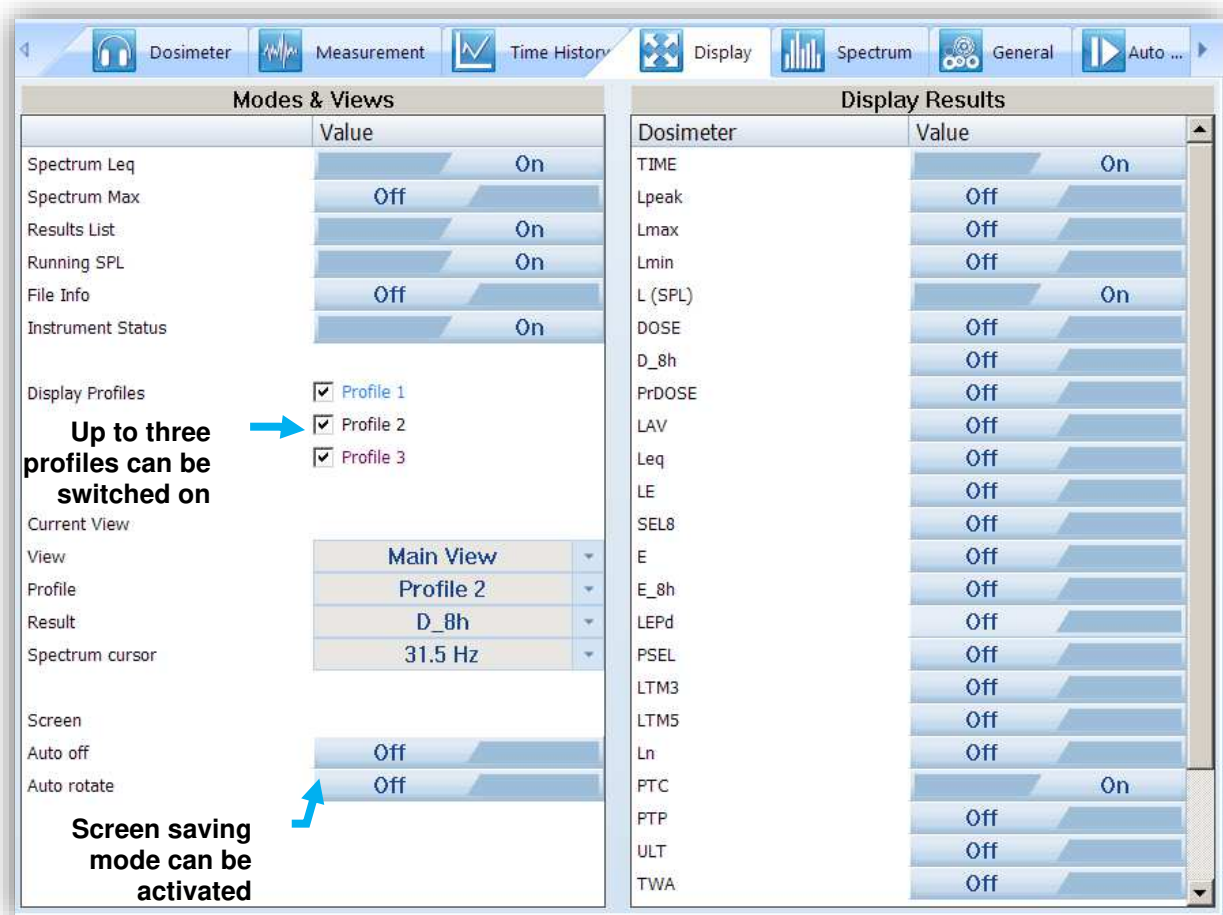


Figure 6-14 Display VIEW configuration tab

6.3.8 Spectrum configuration

Real time 1/1 or 1/3-octave analysis is an additional optional feature. Therefore, it has its own settings tab. Within this tab there are the following panels:

- named **“Data”**: This configures the weighting filter that is to be used with octave calculation
- named **“Display Scale”**: Here the visible dynamic range of the graphical plot can be set, as well as the grid visibility enabled.

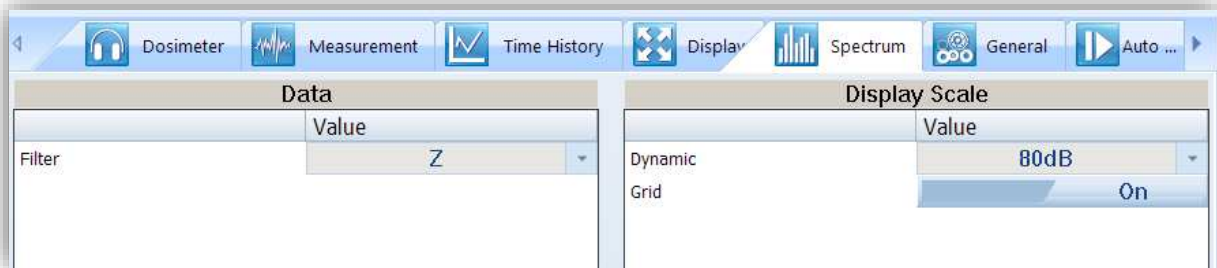


Figure 6-15 Spectrum configuration tab

6.3.9 General settings

General settings tab concerns to many different usability options: see the followed by chapters to understand exactly how to configure these instrument settings.

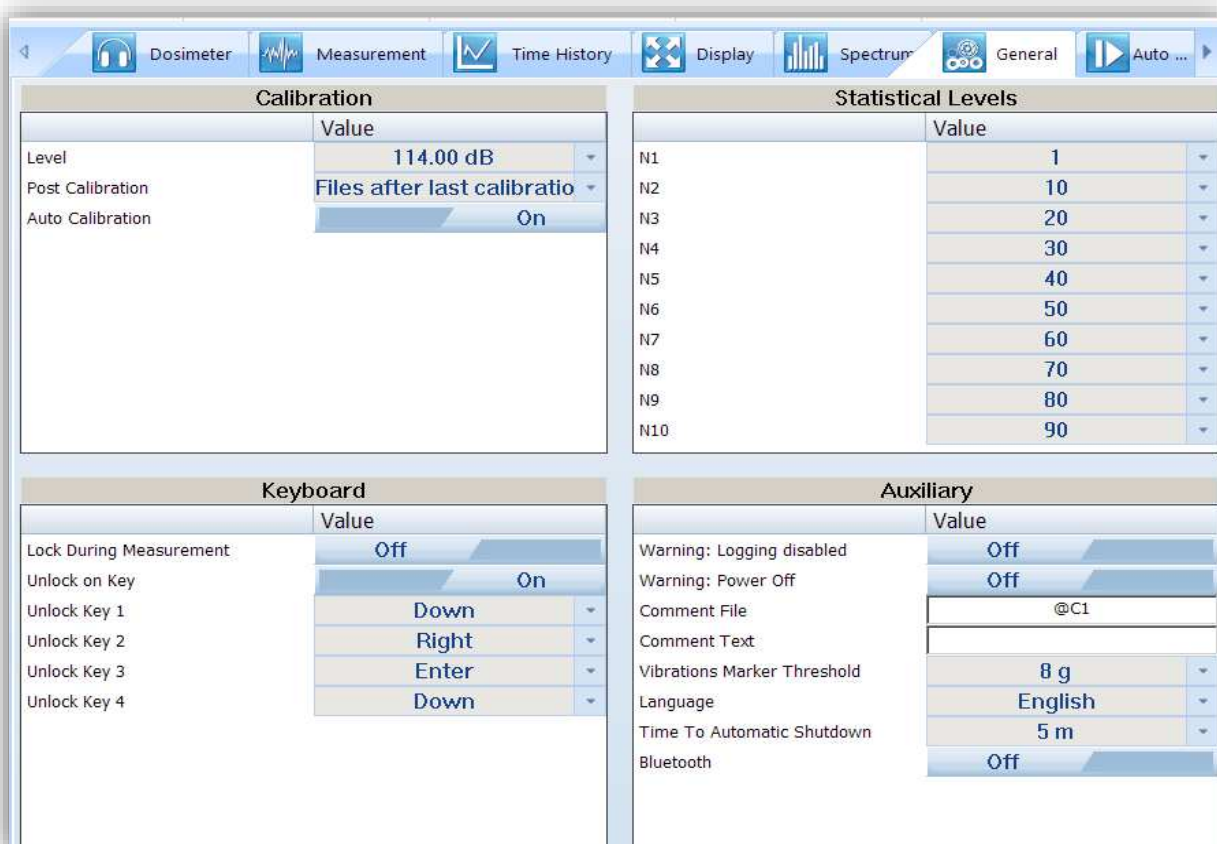


Figure 6-16 General settings tab

6.3.9.1 Calibration

Sometimes it is required to perform so called post-calibration of the instrument. The **Post Calibration** position enables the user to perform additional calibration after a measurement session and add the results to the file saved in the memory. In the panel below, there are three options for saving results: not to save “**Off**”, save in the last file “**Last File**” or save in the files which will be created after last calibration (“**Files after last calibration**”). Auto-calibration can be disabled if required for any reason.

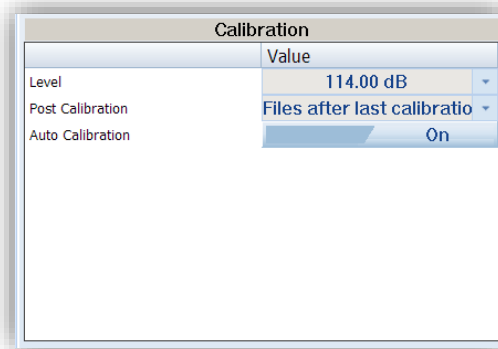


Figure 6-17 Calibration settings panel

6.3.9.2 Statistical levels

In the **Statistical Level** panel, it is possible to define ten percentile statistical levels, named from N1 to N10. The default statistical levels have the following settings: 1, 10, 20, 30, 40, 50, 60, 70, 80 and 90. All values have to be within the integer range [1, 99]. Each value can be set independently from the others.

	Value
N1	1
N2	10
N3	20
N4	30
N5	40
N6	50
N7	60

Figure 6-18 Statistical levels settings panel

6.3.9.3 Keyboard security

The security setting enables you to protect access to the instrument when in use with a simple keypad password to prevent users from inadvertently terminating a measurement run. This feature is set through the **Supervisor's "General"** settings tab.

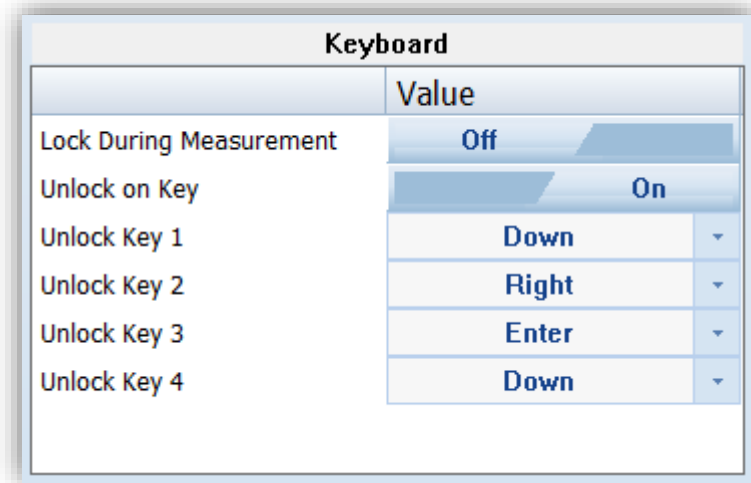



Figure 6-19 Keyboard security settings panel

To turn on the security option: switch on “**Lock During Measurement**”. SV 104BIS will disable the keyboard every time, the measurement run is started.

See Chapter [4.12](#) how to lock and unlock the SV 104BIS instrument.

If “**Unlock on Key**” is set to **On**, SV 104BIS will require special code to be input by pressing four keys defined in this panel in a particular sequence

If “**Unlock on Key**” is set to **Off**, SV 104BIS can be locked/unlocked without providing Lock/Unlock sequence.

Simply hold the  key for a couple of seconds during which a countdown (“**Keyboard lock/unlock**” 3... 2... 1...) is displayed and the unit gives you time to decide if you really want to activate/deactivate the security lock. If you release the key too early, the operation will be cancelled.

6.3.9.4 Auxiliary settings

Under auxiliary settings panel it is possible to:

- Enable additional warning screens to be displayed under certain conditions:
 - “**Logging disabled**” it warns the operator that time history results will not be stored
 - “**Power off**” additional confirmation just before switching off.
- “**Comment file name**” defines the name of the Voice note comment file. “**Comment Text**” is also able to be entered here if required.
- “**Vibration Marker**” is used on the basis of acceleration threshold setting (**Off, 1g,...15g**) the lower the threshold level selected then the more sensitive the dosimeter will be to possible bumps and shocks during use.
- “**Language**” enables the user to change the menu language displayed on the screen of the dosimeter. The default language is English.
- “**Time To Automatic Shutdown**” enables the user to change time period after which the unit will be shut down if no key will be pressed.
- “**Bluetooth**” enables the user to switch on or off the Bluetooth® connection.
- “**Bluetooth PIN**” code configuration is required to establish connection.



Note: For Air-transport **Bluetooth® interface should be turned off**. Make sure that correct settings file is applied.

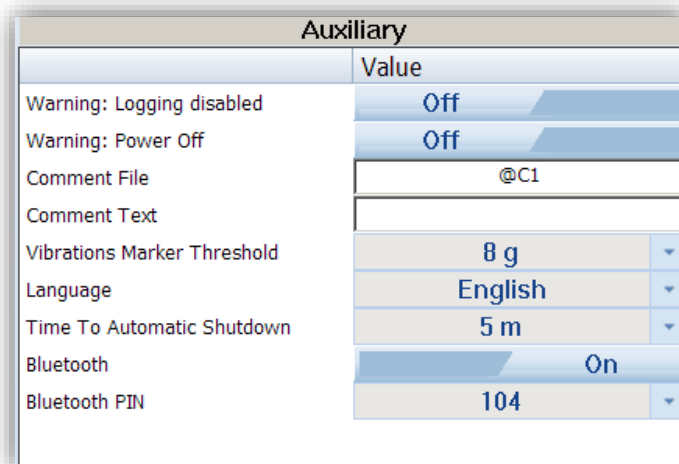


Figure 6-20 Auxiliary settings panel

6.3.10 Auto-Run settings (timer, pauses)

In the **Pause** panel the user may program five independent pauses in real time – **Begin** and **End** of the pause.

The **Timer** panel enables the user to program the internal real time clock to act as a delayed start and stop timer. The instrument can be switched on by itself at the pre-selected programmed time and it can then perform the measurement run, which was used before it was last switched off. Auto-run feature is useful if you wish to pre-set the instruments to run and stop for a specific period, such as a week-long study.

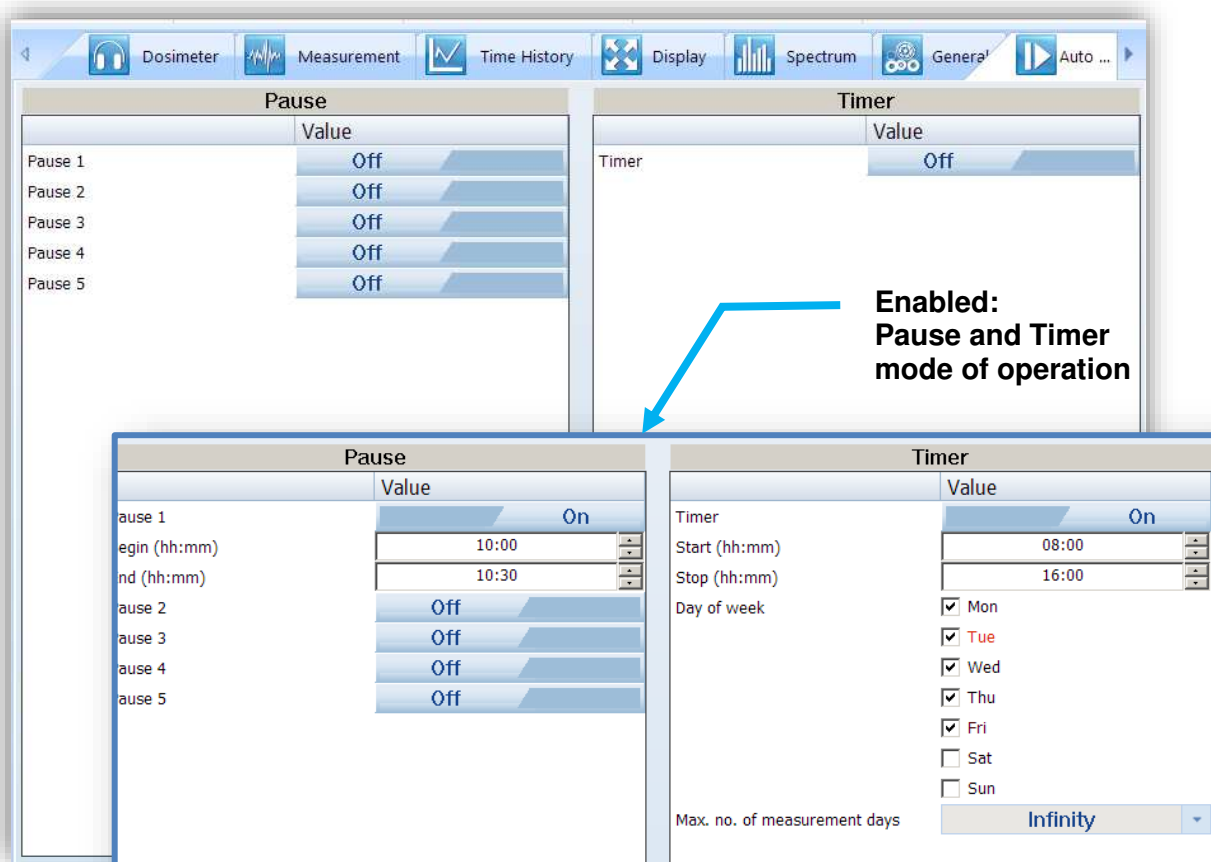


Figure 6-21 Auto-run configuration tab

The timer can be switched off “**Off**” or switched on “**On**”.

In case the timer function is active (**On**) and the instrument is switched on the **Time** screen appears until the programmed measurement runs are finished.

The **Start (hh:mm)** and **Stop (hh:mm)** positions determines the time for the measurement to start and to stop automatically. The required hour and minute should be selected.

The **Day of week** determines the days in a week when the measurements should start. The timer can be programmed (**Max. no. of measurement days**) up to 100 days ahead or without limitation (**Inf**) and during these days’ settings of the current state of the **Real Time Clock** is taken into account. Make sure to check that the real-time clock settings for the measurement location are correct before beginning a delayed timer measurement.

6.3.11 Recording options

Recording tap has two panels – **Event Recording** and **Wave Recording**. For SV 104BIS only the **Wave Recording** option is available.



Note: The **Wave Recording** is an optional function and should be activated before use. Activation of the optional functions can be made with the use of the Supervisor software – see Chapter [6.2](#).

6.3.11.1 Wave recording configuration

In the **Wave Recording** panel, you can configure an audio signal recording in a separate *.wav type file. For this purpose, select the **Recording Mode** other than *Off*, *Continuous*, *Trigger Slope +*, *Trigger Slope -*, *Trigger Level +* or *Trigger Level -*. These modes require different sets of parameters and use different ways of signal recording (triggering) which are described below.

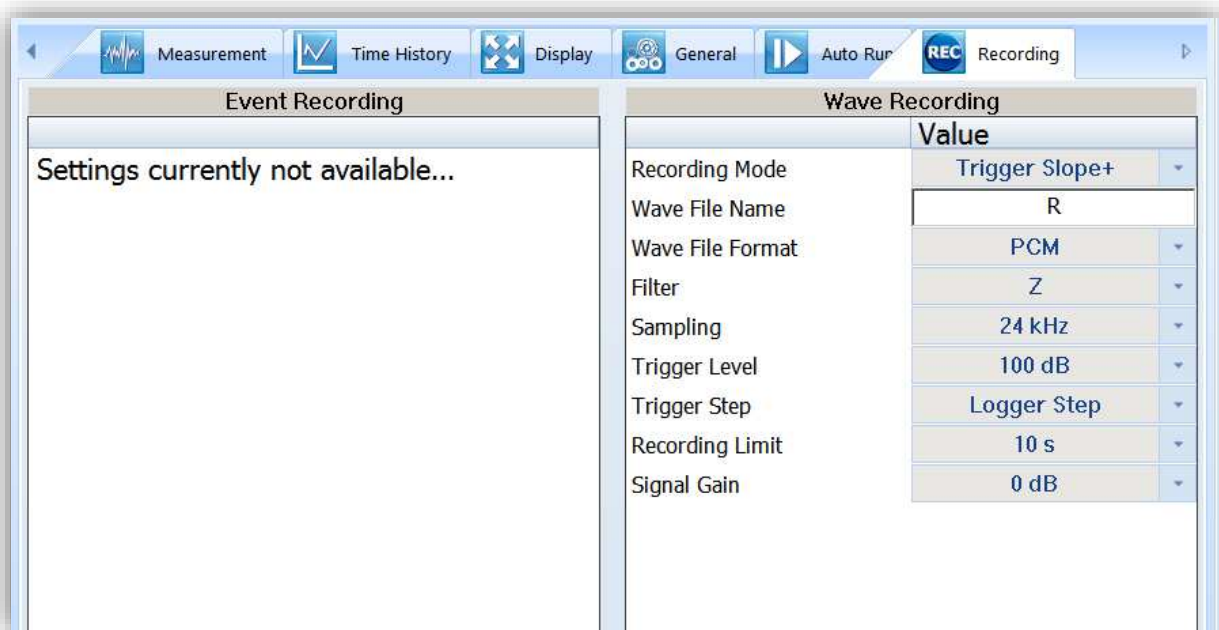


Figure 6-22 Wave recording configuration panels

There are four basic parameters of audio recording available for all modes: **Wave File Format** (*PCM* or *Extensible*), **Filter** (*Z, A, CB*), **Sampling** frequency (*12kHz* or *24kHz*) and **Signal Gain** (from *0 dB* to *35 dB*).

Continuous mode means that the audio recording starts with the measurement start and stops with the measurement stop.

Trigger Slope + / Trigger Slope – modes mean that the audio recording starts when rising value of the *Leq* measured in the first profile by **Trigger Step** (with value equal to *Logger step, 0.5 ms, 100 ms* or *1 s*) passes above/below the threshold level (**Trigger Level**), which means for *Slope +* that the previous result was below the threshold level, and the next one became above the threshold level. The recording lasts for minimum time, defined by the **Recording Limit** parameter, and during this time the instrument continues to check the trigger condition with **Trigger Step** interval. Provided that the **Trigger Step** is shorter than the **Recording Limit**, if next trigger condition is met during the **Recording Limit** time, the instrument triggers recording again, so it will be continued from this moment by additional **Recording Limit** time and so on. If during next recording time there are no triggers, the recording will be stopped after the last trigger plus **Recording Limit** time.

Trigger Level + / Trigger Level – modes mean that the audio recording starts when the value of the *Leq* measured in the first profile by **Trigger Step** (with value equal to *Logger step, 0.5 ms, 100 ms* or *1 s*) is greater/lower than the threshold level (**Trigger Level**). In other cases, the recording doesn't start, but if it has been already started it can be continued until the **Recording Limit** time has elapsed. If during the **Recording Limit** time a trigger condition appears, the recording will be prolonged for another **Recording Limit** time from the moment of that trigger condition and so on. If during next recording time there are no triggers, the recording will be stopped after the last trigger plus **Recording Limit** time.

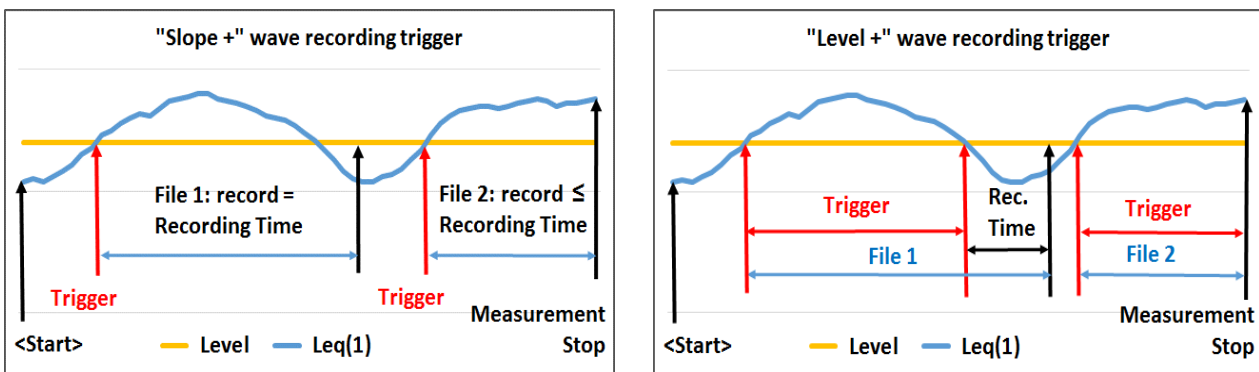


Figure 6-23 *Slope +* vs *Level +* wave recording trigger



Note: In some cases, the instrument may split a wave file automatically! The reason for this is the limited RAM of the instrument in which the audio data is buffered.

6.4 WORKING WITH DATA FILES

6.4.1 Downloading files

In order to download files from the connected Svantek instrument(s), open the *Download* tab in the *Instrument* window.

The *Download* panel contains a list of files stored in the instrument's memory in the form of a table. Various types of files are displayed there, e.g., measurement files, wave files, etc. The first three columns of the table contain basic information about the files: name, size in bytes and date of creation. The last three columns contain additional information (concerning location, users and tasks) assigned to files. Files that have not yet been downloaded are displayed with bold font.

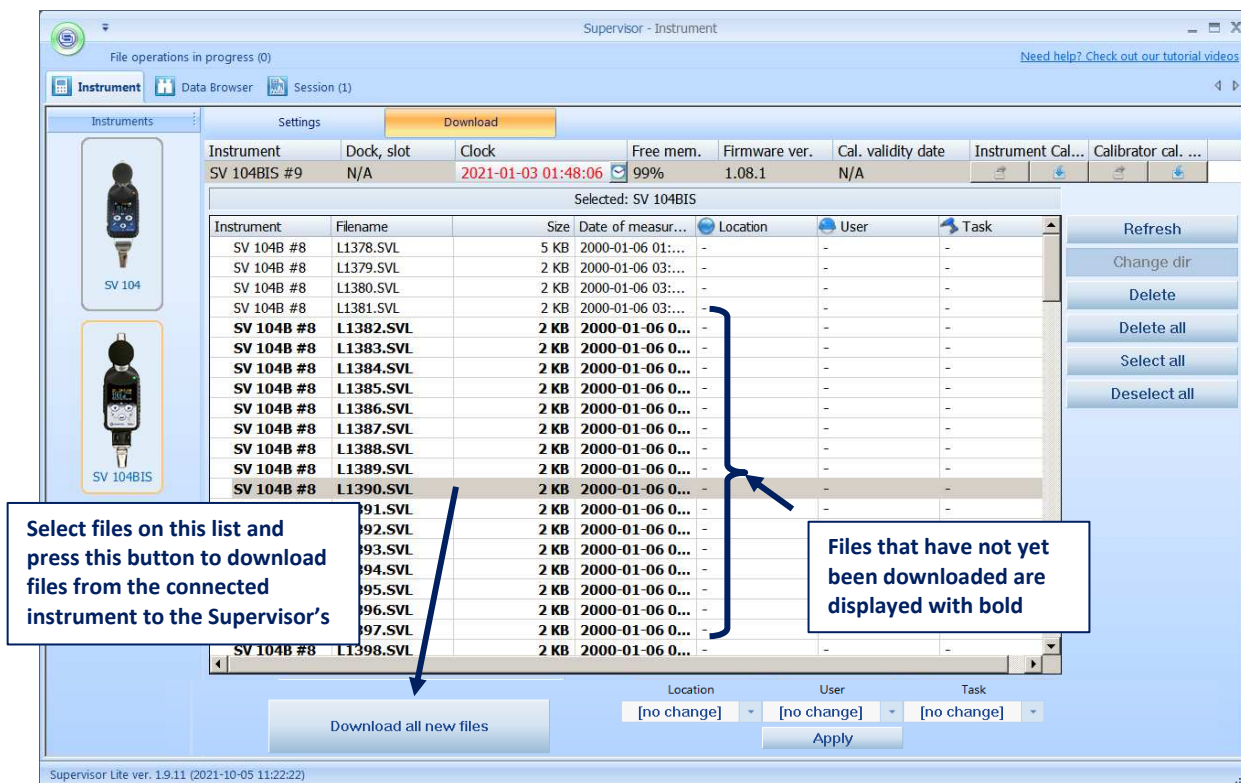


Figure 6-24 SV 104BIS Download window

To download files, use the *Download* button located below the files table on the left side of the *Download* panel. If one or more files are selected in the table, pressing the *Download* button will cause the download of the selected files. Otherwise, pressing this button will cause the download of all of the files stored on the connected instrument.

Note: You can select files by clicking a row of the table. Clicking with the CTRL or SHIFT button pressed allows to select multiple files.

Note: You can download individual files by double-clicking on them.

Files from the instrument are downloaded to the special internal Supervisor catalogues that are created automatically in the parent catalogue with the name "Catalogue". Created catalogues by default have names of the instruments, for example, SV 104B, SV 104BIS, etc.

After the downloading procedure is completed, a window, containing information about success or failure of downloading, is shown.

The buttons located at the right side of the Download panel enable you to perform some basic operations concerning the files stored in the connected instrument:

- *Refresh* – updates the list of files, so that all the files created after you entered the Download panel will also be shown.

Note: Every time the list of files is refreshed, a new “downloading session” begins, i.e. a new subdirectory is created for the downloaded files. This is why sometimes the overwrite warning does not appear even though two files of the same name are downloaded — after beginning a new download session, the file will be stored in a different location, thus eliminating the possibility of overwriting.

- *Change dir* – for SV 104BIS instruments this button is inactive.
- *Delete* – deletes a selected file from the instrument’s memory.
- *Delete all* – deletes all result, logger, and WAVE files in the instrument’s current working directory.
- *Select all* – selects all files in the table.
- *Deselect all* – clears the selection.

All downloaded files are stored in the Supervisor’s database and they can be viewed and processed using the Data Browser, which is described in the following chapter. The Data Browser is automatically opened each time files are downloaded from a connected Svantek instrument.

Whenever you download / upload files from / to a connected instrument, Supervisor displays the progress in the *File operations* panel, located at the top-left corner of the application window.

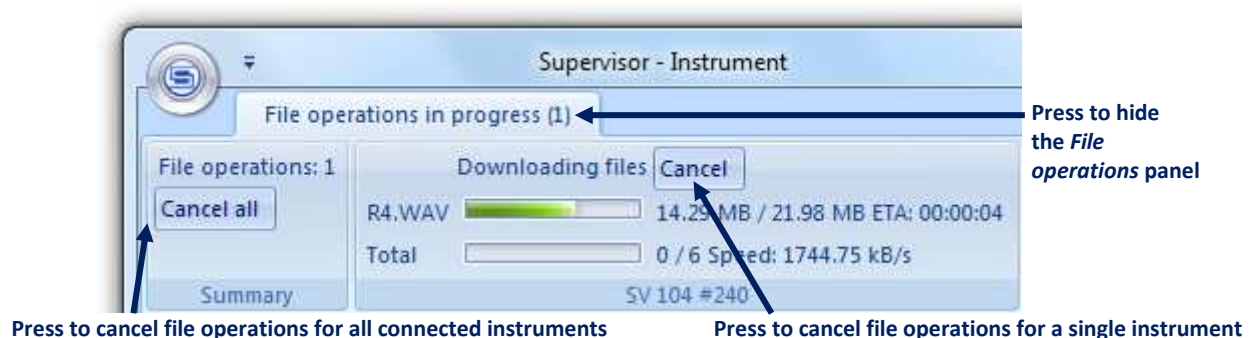


Figure 6-25 File operations panel

Each instrument can perform one operation at a time. If multiple instruments are connected and performing file operations at the same time, you can cancel them all by pressing the *Cancel all* button.

You can show/hide the *File operations* panel by clicking on the *File operations in progress* tab.

6.4.2 Data Browser

In order to view all the files downloaded from Svantek instruments and stored in the Supervisor’s database, open the Data Browser using the button located in the top-left corner of the Supervisor window.

The Data Browser is composed of three panels:

- on the left side of the window, the File manager panel contains a list of all files stored in the Supervisor’s database and allows you to select a group of files to be displayed in detail

- on the right side of the window, the File list panel contains a list of files belonging to a selected group and allows to open a file for further processing
- below the file list panel, the File preview panel enables to preview data contained in a selected file.

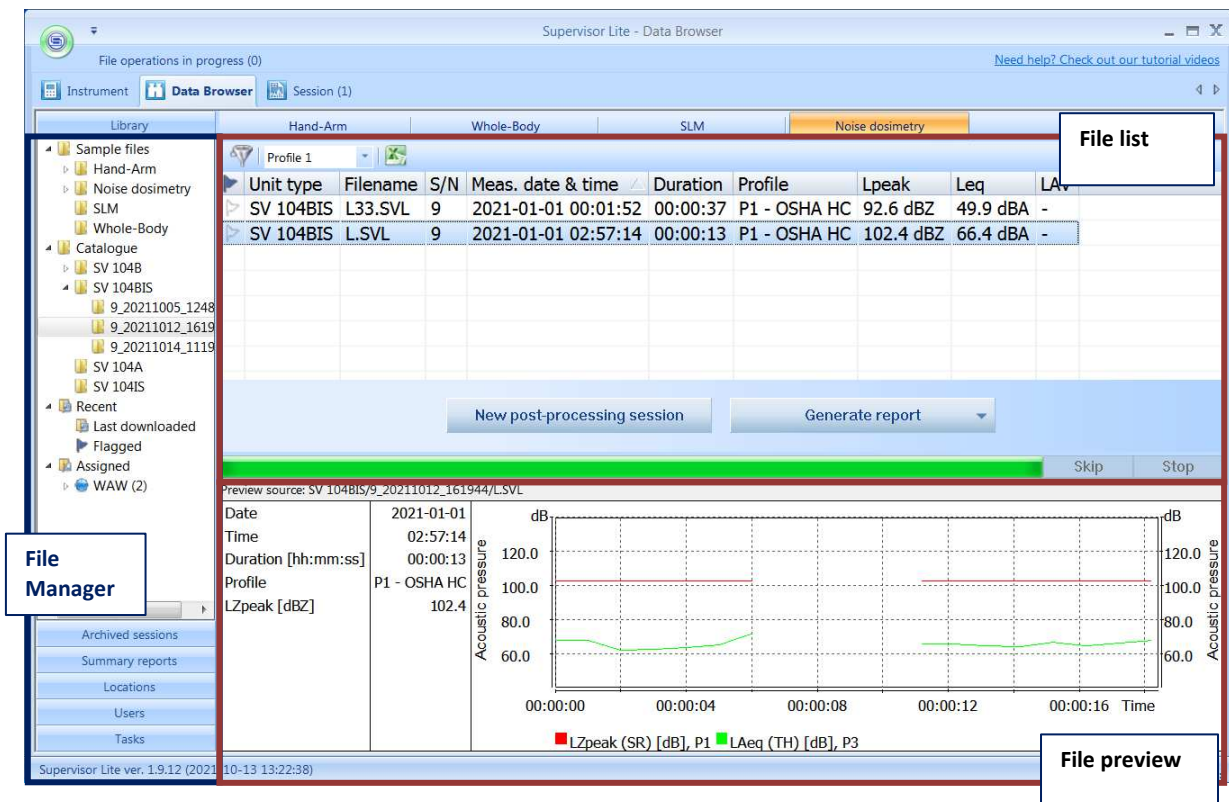


Figure 6-26 Data Browser window

6.4.2.1 File Manager

The File Manager panel can be used to select a group of files to be displayed in detail. It is divided into six sub-panels: *Library*, *Archived sessions*, *Summary reports*, *Locations*, *Users*, and *Tasks*. Each of them can be accessed by pressing the horizontal bar with the respective name.

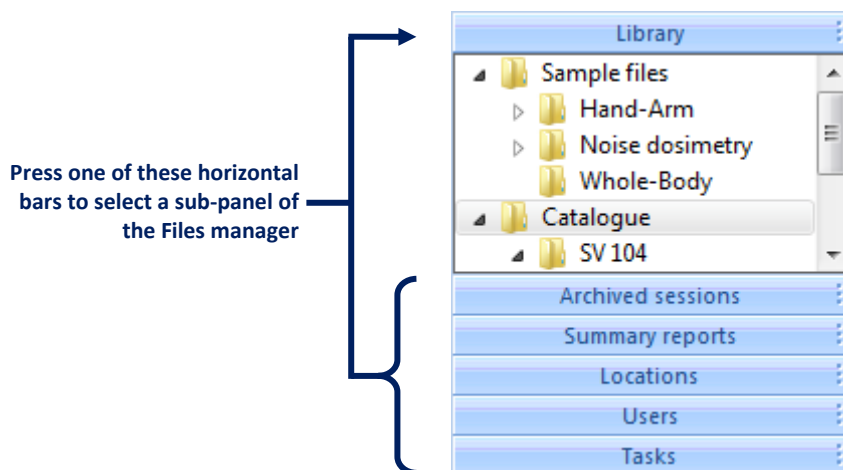


Figure 6-27 File manager

The *Library* sub-panel lists all the files stored in the database using a tree view. It contains four base items:

- *Sample files* containing some sample files provided with Supervisor, grouped further according to the type of measurement they refer to.
- *Catalogue* containing all the files downloaded from instruments. You can arrange the Catalogue in any way by adding, deleting, moving and renaming files and folders. You can easily move files and folders, as well as add them to the database from any location on the PC, using the drag & drop technique. You can also use the context menu, opened by right-clicking, for various operations on files and folders.

Note: It is also possible to export files from the Supervisor's database using the drag & drop technique outside the application window (dropping files into Windows Explorer).

Note: The catalogues for the downloaded files are created automatically in the *Catalogue*. Created catalogues by default have names of the instruments, for example, SV 104B, SV 104BIS, etc.

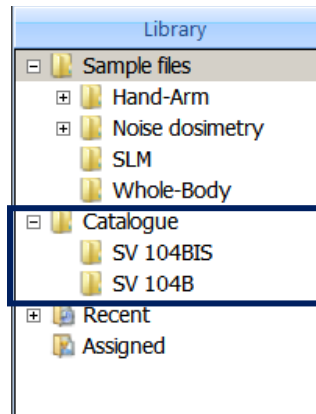


Figure 6-28 Example of the Catalogue content

- *Recent* containing two sub-items: *Flagged*, which is a folder for grouping a number of selected files—in order to add a file to this group, you have to set its *flag*, which can be done in the File details panel; and *Last downloaded*, which contains a list of files downloaded since the last launch of Supervisor.
- *Assigned* containing all files to which additional information about location, user, and task performed during measurement have been assigned.

The *Archived sessions* sub-panel contains a list of all the sessions that have been moved to archive. You can use this list to restore an archived session for viewing and processing it again, or to use files which have been used to create that session. In case many sessions are archived, you can use filters to display only some of them.

The *Summary reports* sub-panel contains a list of Summary reports that you have created. The *Summary reports* can be used to gather selected measurement results according to additional information that has been assigned to them.

The last three sub-panels of the File manager contain files listed according to additional information assigned to them.

6.4.2.2 File details

The File details panel contains a table in which files corresponding to the selected item of the File manager are listed. The files corresponding to all sub-items of the selected item are also shown in the Files details panel. Files can be further processed by using them for sessions. In order to create a session, select one or more files and press the *New post-processing session* button. If you want to create a session starting with only one file, you can do it by double-clicking with the left mouse button the row of the table corresponding to that file.

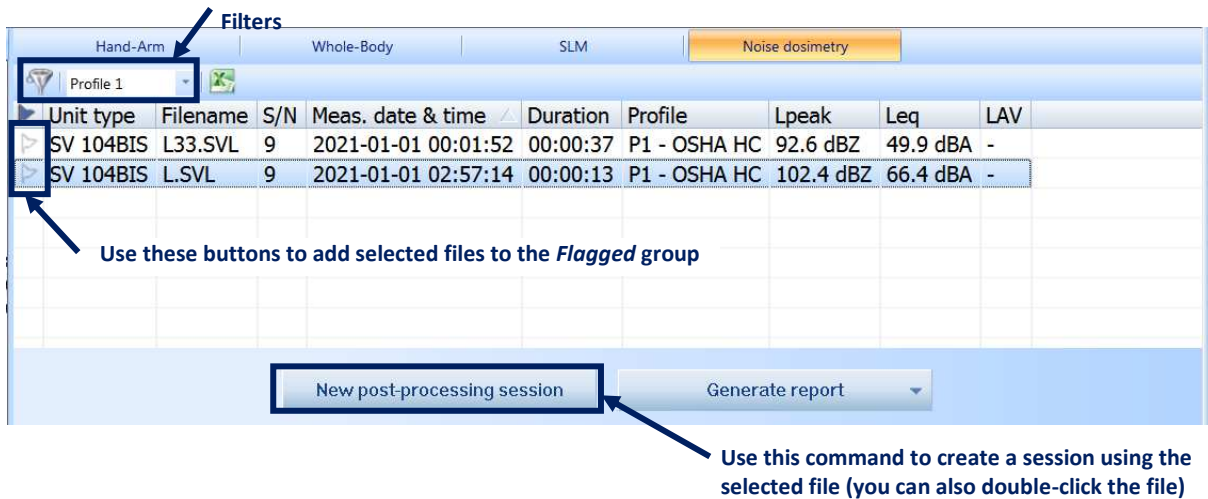



Figure 6-29 File details panel

Setting flags

By pressing the  button located in the first column at the left side of the File details table you can set a flag for a selected file. As a result, the file will be accessible in the File manager in the *Recent* → *Flagged* group. You can flag several files in order to get a quick and easy access to them.

Dragging files outside Supervisor

You can easily export files from the Supervisor's database to a selected location on the PC using the drag & drop technique outside of the application window.

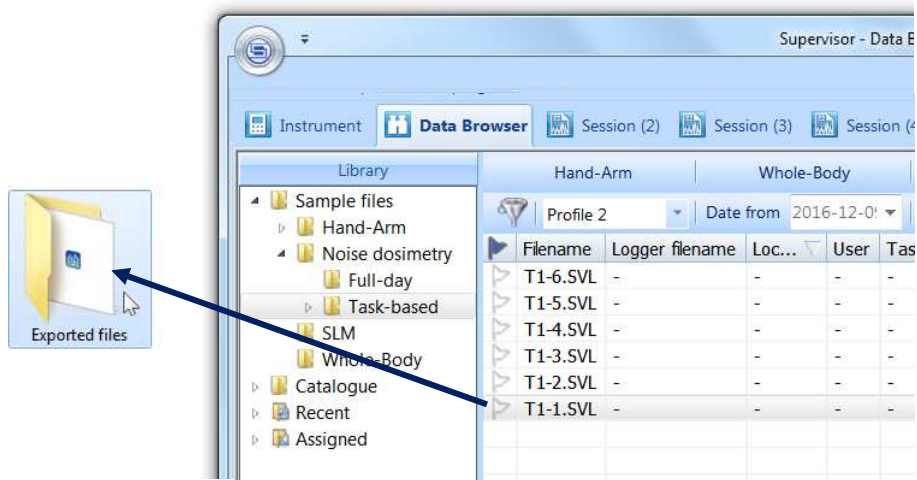


Figure 6-30 Using the drag & drop technique to export files outside the Supervisor's database

Note: Exporting measurement files with comments (e.g. WAVE files) attached to them automatically exports the comment files too. In order to export a single file without the attached comments, use the drag & drop technique with the CTRL button pressed.

Creating reports

You can generate a report of the selected file(s) based on some templates using the *General report* button. After pressing this button, you should select a template for the report.

All reports are saved in the *Summary reports* sub-panel.

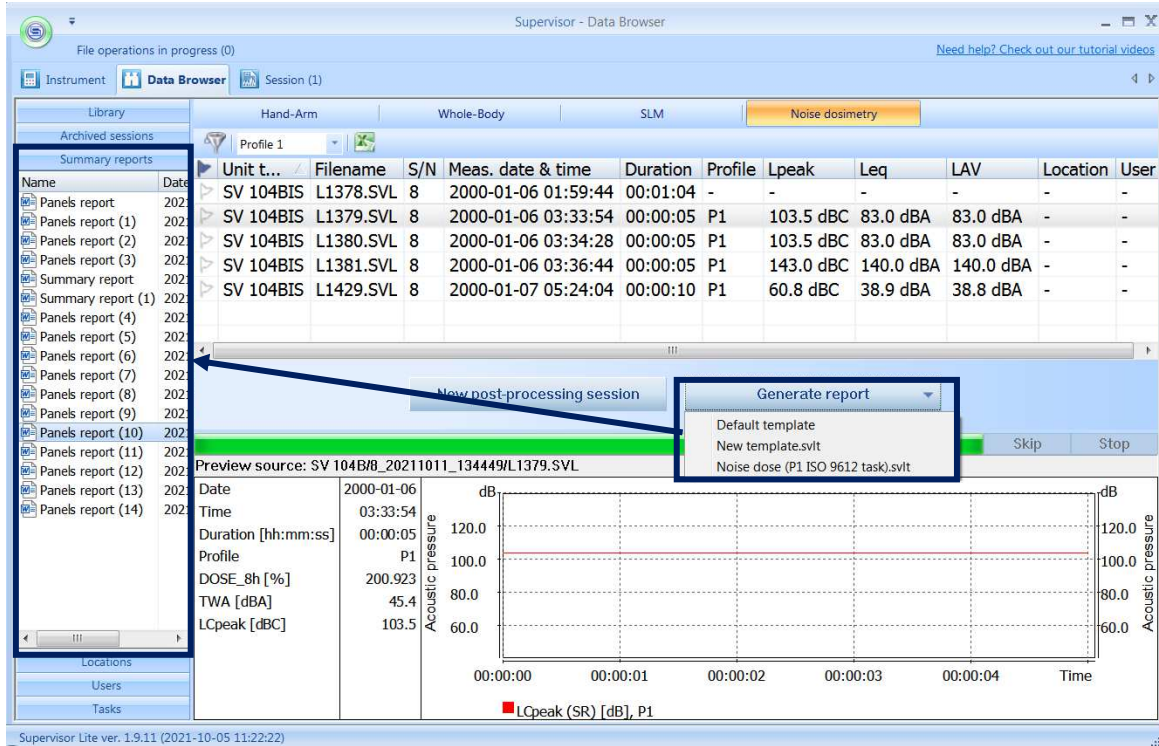


Figure 6-31 Creating general reports

6.4.2.3 File preview

The panel below the File details table provides a short preview of the data stored in the selected file, giving an initial idea of the time history of the measurement results. In case multiple files are selected, the file which is actually used as source of displayed data is specified in the top left corner of the Preview panel.

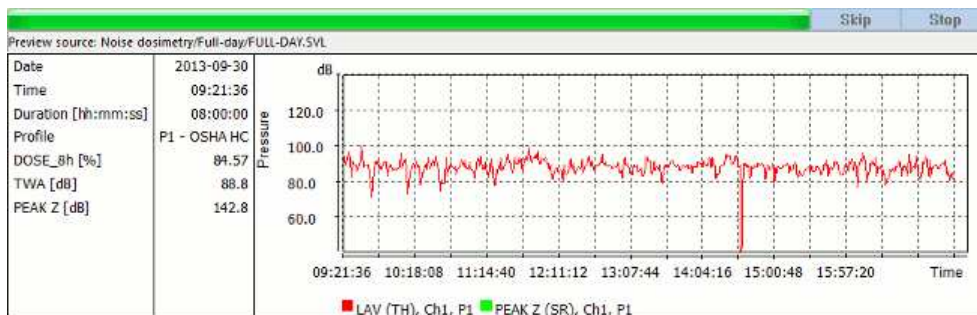


Figure 6-32 Preview panel

It is possible to copy the contents of the Preview panel by right-clicking in its area and activating the *Copy* command. It can then be pasted as an image in another application, such as e.g. MS Word.

You can specify the kind of data (and the order of their priority) to be displayed in the Preview panel using the Preview settings in the Main Options dialog box. Different kinds of data are available for different applications. To choose the application, use the list box at the top of the *Preview* settings panel. It is possible to select different kinds of data for the *Parameters & results panel* (on the left hand side of the Preview panel, displaying data in numerical form) and for the *Plot panel* (on the right hand side of the Preview panel, displaying data in graphical form).

6.4.2.4 Using assignments

Three types of additional information can be assigned to each file downloaded from a Svantek instrument:

- *Location* (where the measurement was carried out),
- *User* (whom the measurement concerned),
- *Task* (which was being performed by the user during the measurement).

This information can then be used to facilitate searching for particular measurement results and to generate summary reports.

You can assign this additional information to the files when you download them from the connected instrument. For this, in the *Instrument* → *Download* panel, select one or more files, select the *Location* / *User* / *Task* in the respective list-box located at the bottom-right corner of the window and press *Apply*. If you want to add a new location, user or task, in the list-box select *[new...]*. If you want to erase information already assigned, select *[none]*. Chosen values will be assigned upon downloading files to the Supervisor's database.



Figure 6-33 Assigning additional information to downloaded files in the Instrument → Download panel

You can also assign additional information to files in several ways using the *Data Browser*. In the File details table, left-click on the *Location* / *User* / *Task* field corresponding to a selected file, and select a value from the menu.

	User	Task
	-	-
	John	-
	[none]	
	Zdzichu	
	John	
	[new...]	

A context menu is open over the "John" cell in the User column, showing the same list of options as in Figure 6-33: "[none]", "Zdzichu", "John" (highlighted in yellow), and "[new...]".

Figure 6-34 Assigning User information to a file in the File details table

Another method for assigning information to files is to drag & drop a file from the File details table to a particular item in the *Assigned* sub-tree in the Library. Notice that if you, for example, drop a file to a sub-sub-item corresponding to both a User and a Task, both these values will be assigned to that file.

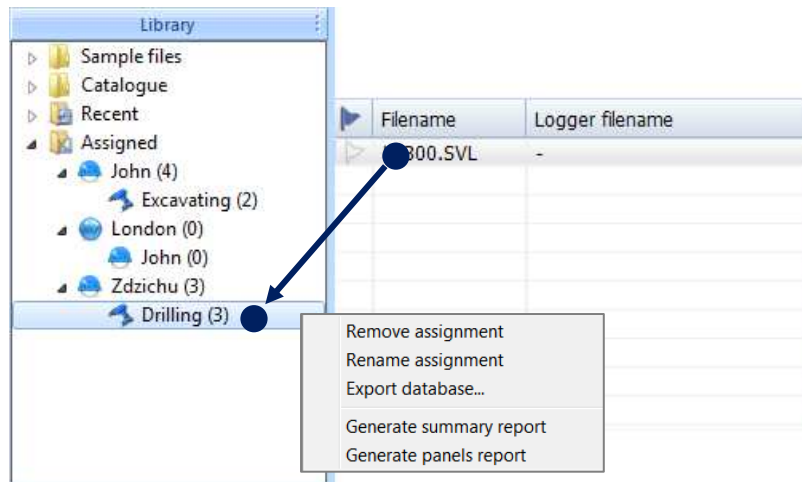


Figure 6-35 Assigning additional information to files using the drag & drop technique

Right-clicking on the item in the Assigned section, you can remove, and rename assignments.

6.4.2.5 Summary reports

The summary reports can be used to gather measurement results related to selected locations, users, or tasks, in the form of MS Word documents. In order to create a summary report, right-click on an item corresponding to an object in the *Assigned* sub-tree in the Library sub-panel of the File Manager and select *Generate summary report*. This command opens the Summary report wizard. You can also use the "Assigned" root item to create a summary report for all the files that have a location, user and/or task value assigned to them.

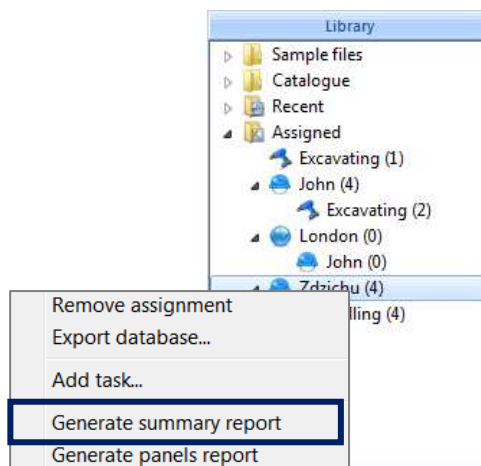
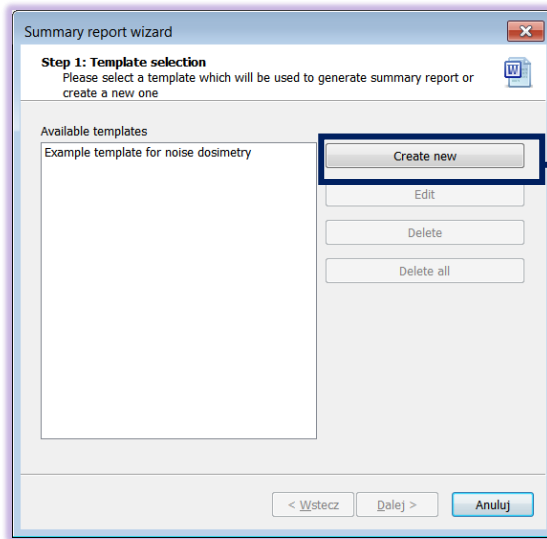


Figure 6-36 Using the Library to generate a summary report

A summary report must be created according to a template. The first window which appears when the Summary report wizard is opened allows to select a template for the report. When you generate your first summary report, you need to create a new template, but the template will be saved, and you can use it later

to generate more reports. In order to create a template, press the *Create new* button. The Summary report template editor window will appear.

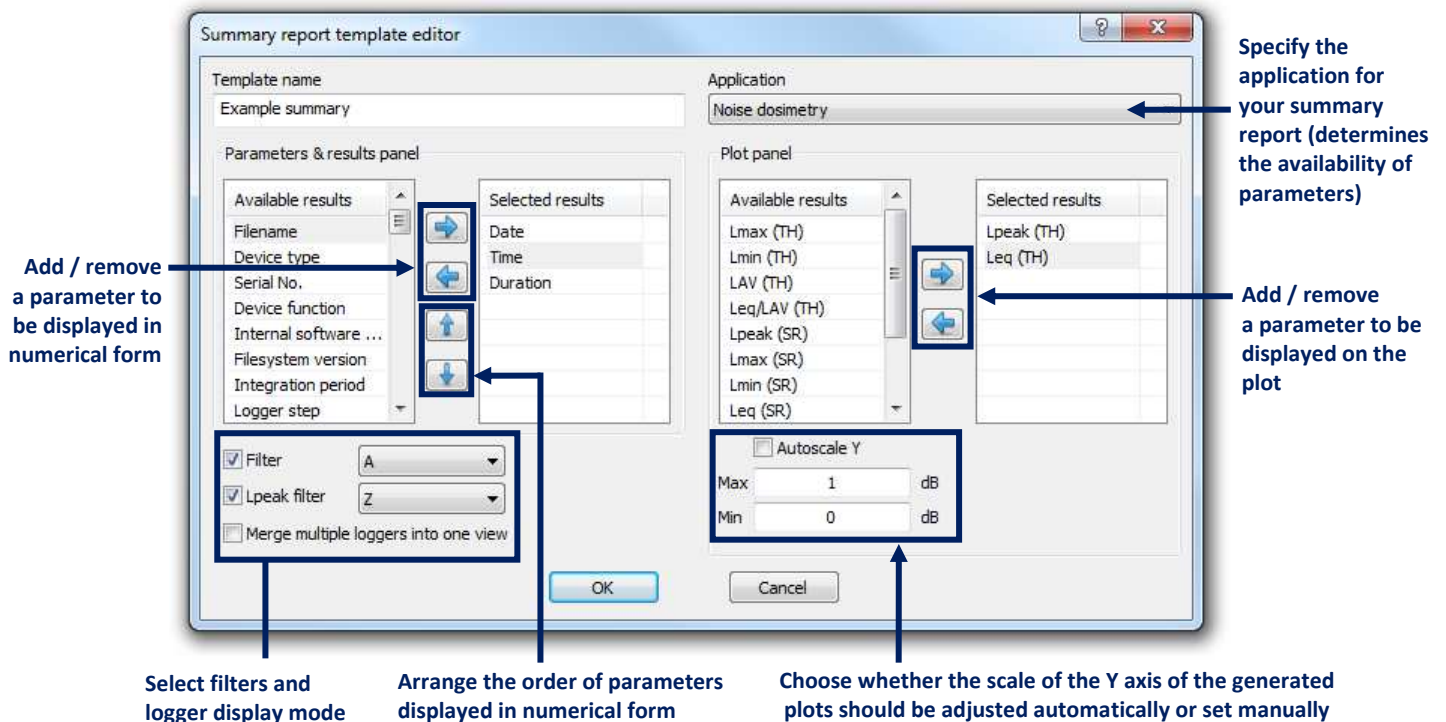
Note: You can also create multiple templates; later you will be able to choose one of them each time you generate a summary report.



Press this button to create a new template and proceed with generating a summary report

Figure 6-37 Summary report wizard initial window

A template of the summary report consists of a set of parameters (*i.e.* the parameters of the Svantek instrument, parameters of the measurement, and measured quantities) to be displayed in numerical form, and another set of parameters to be displayed on a plot. In order to create a template, first specify the application you intend to use it for, since it determines the availability of particular parameters. The application can be specified using the list box in the top-right corner of the window. Next, select the parameters to be included in the report using the template editor.



Select filters and logger display mode

Arrange the order of parameters displayed in numerical form

Choose whether the scale of the Y axis of the generated plots should be adjusted automatically or set manually

Figure 6-38 Summary report template editor dialog box

After you have created a report template, you can select it on the list of the Summary report wizard and press the *Continue* button to proceed. In the second step of generating the summary report, you can select the time interval from which results will be included. After specifying the minimum and maximum date, press *Finish* to generate the report.

6.5 SESSIONS AND REPORTING

Sessions can be used to work with data downloaded from Svantek instruments and to create reports containing these data.

6.5.1 Creating and managing sessions

To create a session, go to the *Data Browser*. In the File Details table, select the files which contain the data you wish to work with, press the *New post-processing session* button or right-click and select the *New post-processing session* command in the opened menu. You can create a session with one or multiple files. To create a session from a single file just double-clicking it.

Note: You cannot create sessions directly from the wave file itself.

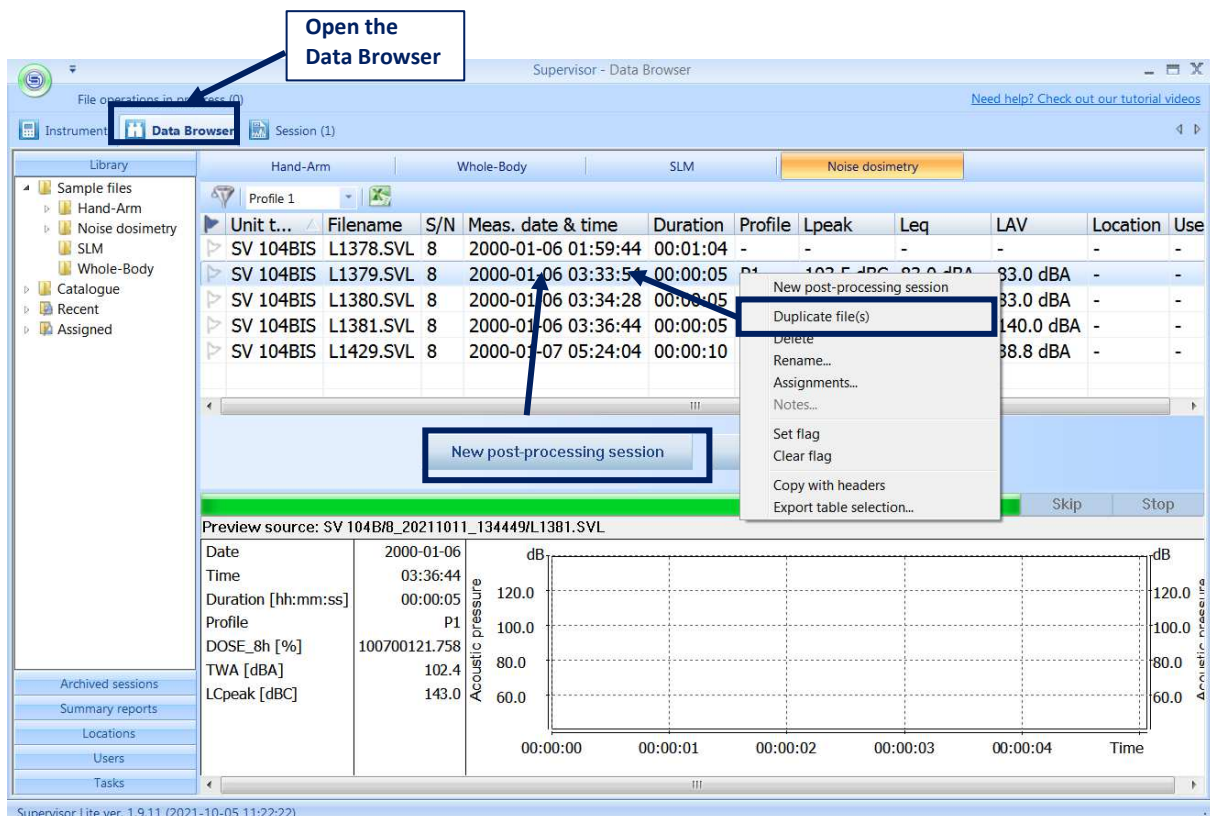


Figure 6-39 Creating a new session using the Data Browser

After using above mention commands, the special window appears in which you should choose the template for the post-processing session.

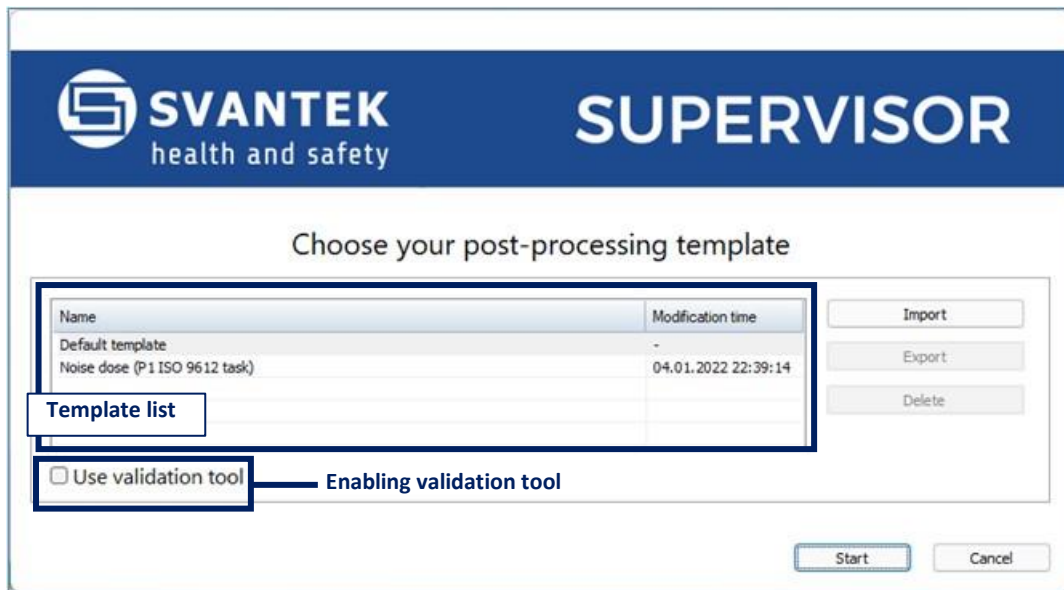


Figure 6-40 Choosing post-processing template

The template list consists includes predefined templates: *Default template*, templates related to the results type, for example, *Noise dose (P1 ISO 9612 task)*; and templates created by the user, for example, *New template*. You cannot delete predefined templates. User templates and results type related templates can be exported (saved as the .svlt file) to the any catalogue on the PC. You can also import the previously exported template.

For each new session a tab is created on the bar at the top of the application window. To open a session, click on the tab. By right-clicking on a tab you can open a context menu, allowing to specify a custom name for a session or to close it. You can close a session in two ways: by deleting it (permanently), or by moving it to the archive, which will allow you to later work with that session again. Deleting a session does not cause measurement files to be deleted. The archived sessions are available in the Data Browser, in the *Archived sessions* sub-panel of the File Manager. Using the *Delete all sessions* command it is possible to delete all the currently opened sessions at once.



Figure 6-41 Tabs corresponding to the opened sessions


You can also close a session using the *Move to archive* and *Delete session* buttons, located at the bottom-left corner of the window.

6.5.2 Validation tool

The Validation tool is used to check the correctness of the measured data and, if necessary, to reject "disturbances".

After creating a session with the *Use validation tool* option, the logger results view will appear with the Validation tool open on the left enabling automatic searching for markers areas:

- NoMotion,
- High vibration level,
- Audio, which serves as a basis to judge by ear whether a given fragment is correct or not.

You can move between the following ranges of these markers with the buttons , where the selected range is highlighted with a block on the time history.

If there is an audio signal available within a given fragment of the time history, you can listen to it.

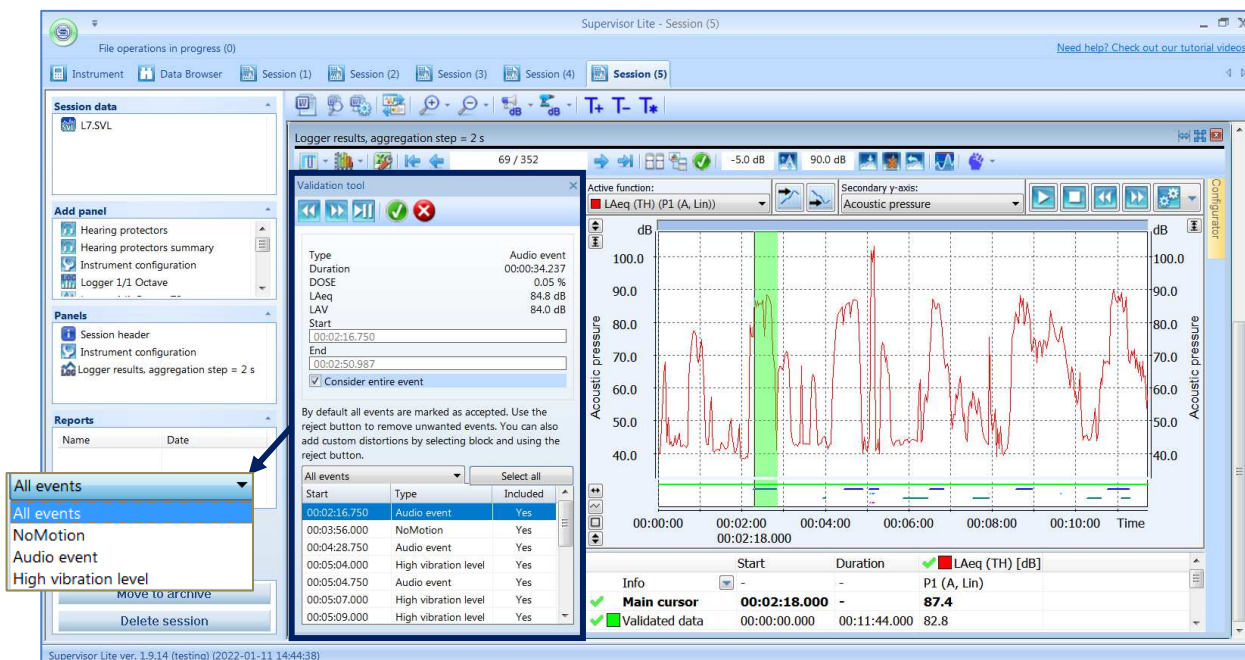




Figure 6-42 Validation tool panel

The following information is displayed for the following ranges:

- *Type* - the type of disturbance (i.e. the name of the marker)
- *Duration* - the length of the selected fragment
- *DOSE / LAeq / LAV* - dose / LAeq / LAV calculated for the selected fragment
- *Start / End* - start and end that can be manually "corrected" if we find that a larger or smaller fragment of the time history should be excluded from further calculations
- *Consider entire event* - is used to select the whole fragment of a given disturbance (selected by default) or if you want to enter it manually, you should uncheck it.

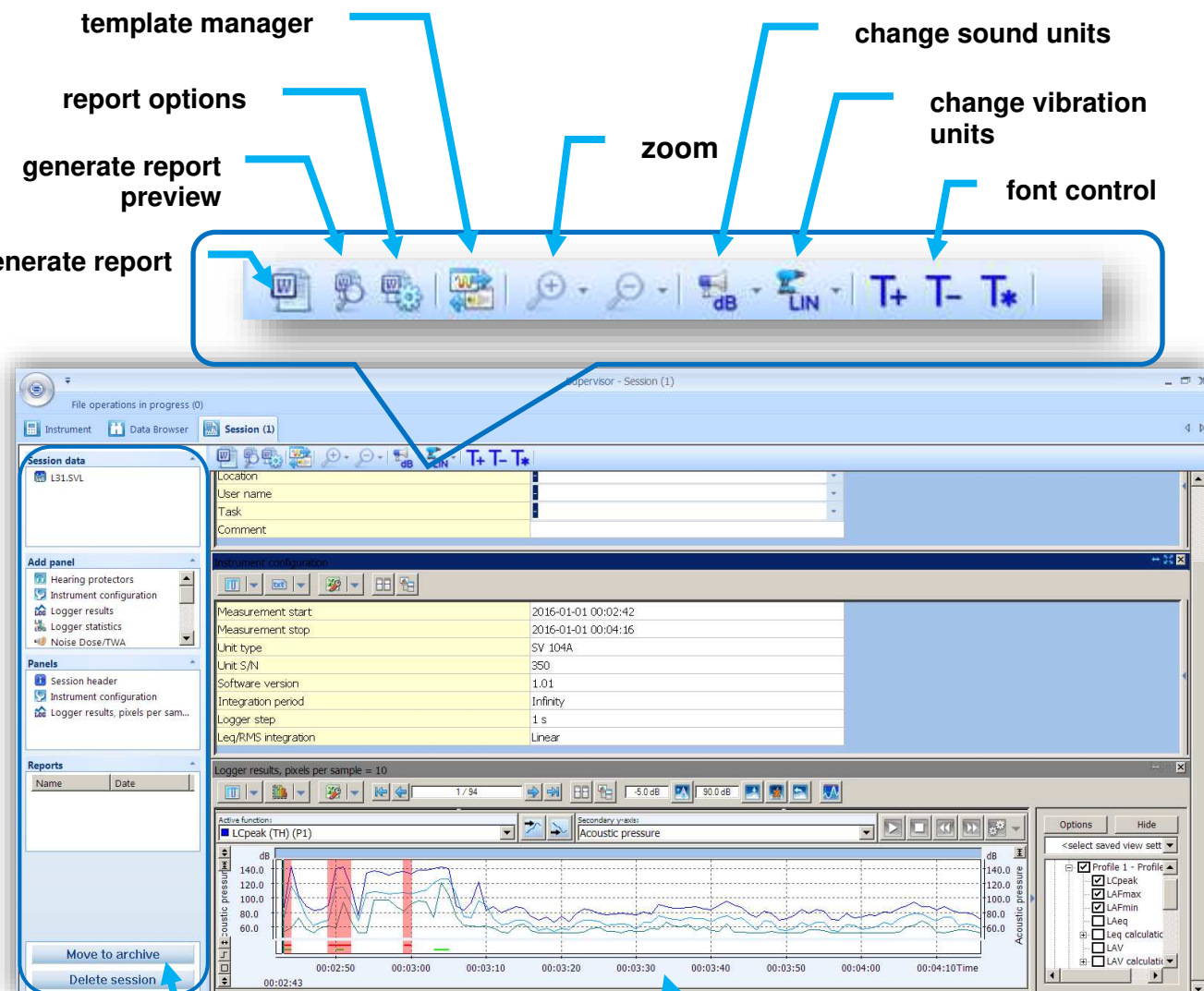
The disturbances list is presented on the bottom part of the Validation tool panel. The disturbances list is synchronized with the cursor on the time-history graph, so that if you select the item in the list the cursor will be show this event on the right graph.

Clicking the left selector above the disturbances list header, you can apply the filter, for example, *NoMotion*, *Audio event* or *High vibration level*. Clicking the left button above the disturbances list header, you can select or deselect all items in the list.

Jumping on successive disturbances and selecting them with the  button rejects a given fragment from the calculations, while the  button causes the acceptance of that fragment. There is a short blink when accept / reject is used.

The Validation tool generates the "Valid data" marker that specifies the correct fragments of the time history that are taken into calculations in other calculation panels.

6.5.3 Session's Tollbar



The image shows the Supervisor main SESSION window with several annotations pointing to specific features:

- template manager**: Points to the 'W' icon in the tollbar.
- report options**: Points to the 'W' icon with a gear in the tollbar.
- generate report preview**: Points to the 'W' icon with a magnifying glass in the tollbar.
- generate report**: Points to the 'W' icon in the tollbar.
- zoom**: Points to the '+' and '-' magnifying glass icons in the tollbar.
- change sound units**: Points to the 'dB' icon in the tollbar.
- change vibration units**: Points to the 'LIN' icon in the tollbar.
- font control**: Points to the 'T+', 'T-', and 'T*' icons in the tollbar.
- SESSION configuration panel**: Points to the left sidebar containing session data, add panels, and reports.
- report detailed configuration area**: Points to the bottom right area containing options and a list of saved view sets.

The main window displays session data for 'L31.SVL', instrument configuration, and a graph showing 'LCpeak (TH) (P1)' and 'Acoustic pressure' over time. The graph shows a peak in acoustic pressure around 00:02:50.

Figure 6-43 Supervisor main SESSION window

6.5.4 Session source data

The measurement data used to create sessions are contained in files, stored in the Supervisor's local database. Several files can be used to create a single session. A list of files which have been used to create the currently opened session is displayed in the *Session data* panel at the top-left corner of the window.

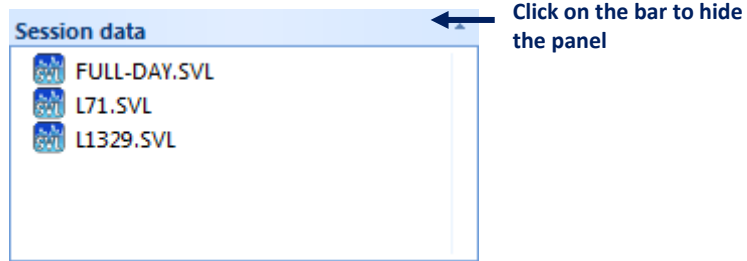


Figure 6-44 Session data panel, containing a list of files which have been used to create the current session

Once a session is created, you cannot modify its data source. If you want to use different files in a session, you must create a new session with these files.

6.5.5 Session Panels

Panels are the basic building blocks of the reports created using Supervisor's sessions. They can be used to configure the way data will be displayed in the report.

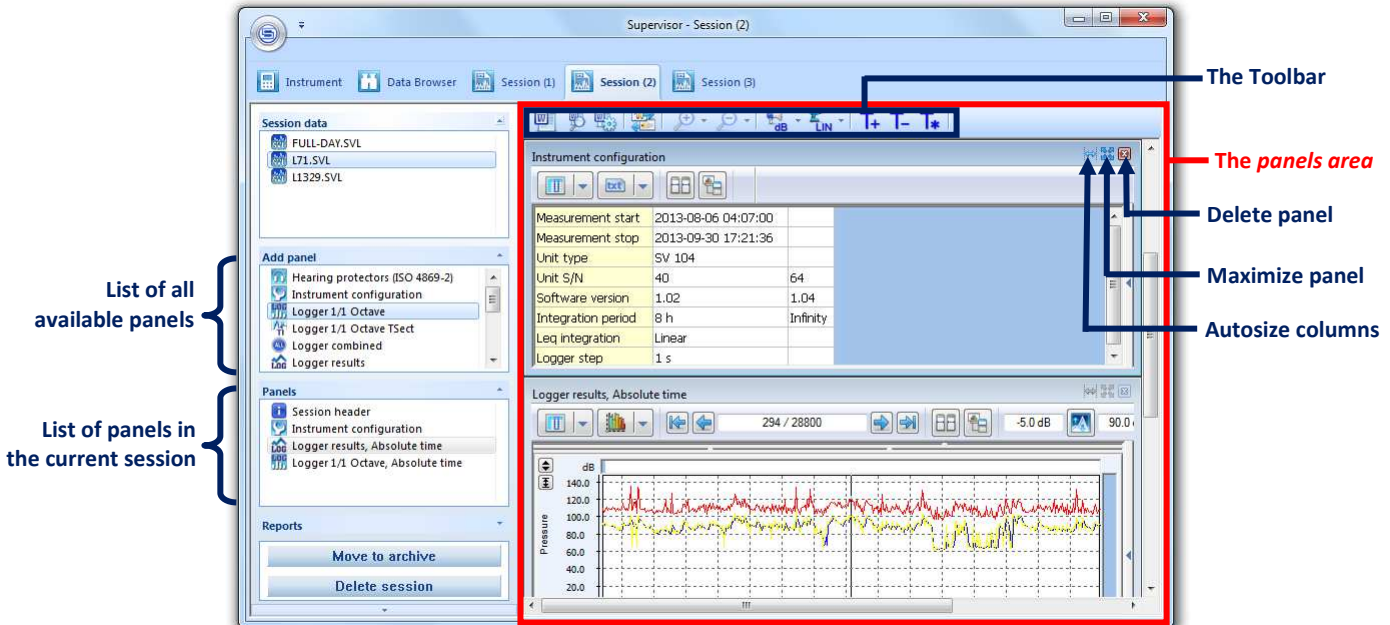


Figure 6-45 Panels in the Session window

The *Add panel* list (at the left side of the window) shows all types of panels available for the current data. You can add a panel to the current session by double-clicking on its name in this list.

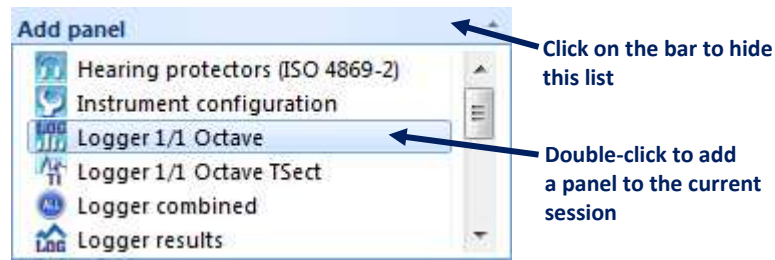





Figure 6-46 Add panel list of all panels available for the current data

You can add any number of panels you want, including multiple panels of the same types. All panels added to the current session are listed in the *Panels* list, located at the left side of the window. You can use this list to jump to a selected panel by double-clicking it. You can also rename a panel by selecting it and clicking its name, or by pressing the F2 key when a panel is selected.

To delete a panel, use the  button located at its top-right corner. To make it fill the whole panels area, use the  button. By clicking the  button once again you can shrink the panel to its previous size.

Panels are automatically scaled to fit the size of the panels area in horizontal direction. Their order in the vertical direction specifies the order in which data will be contained in the report. You can change the position of a panel using the drag & drop technique.

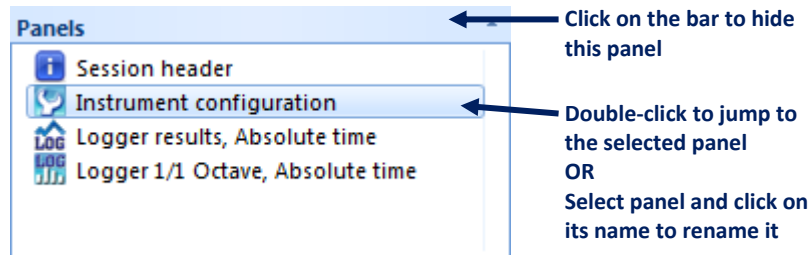


Figure 6-47 Panels panel, containing a list of panels added to the current session

Each panel is equipped with the *Configurator* tool that allows you to select the information to be displayed on the panel.

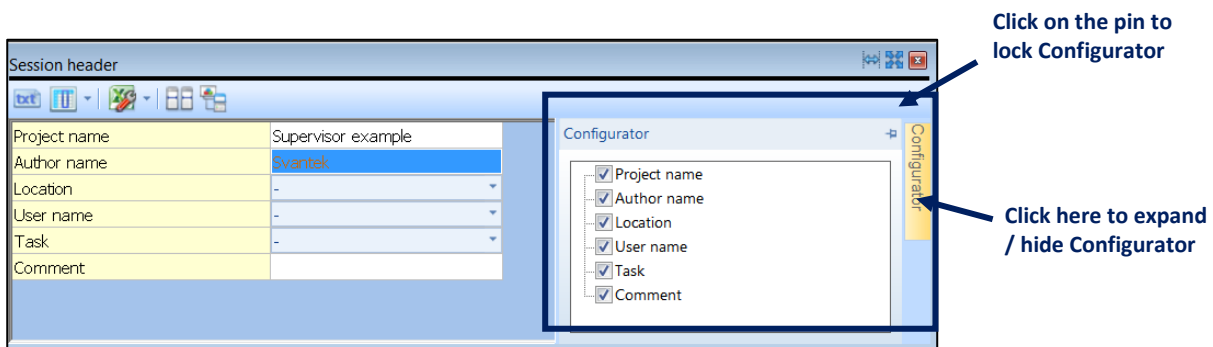


















Figure 6-48 Configurator tool

The available types of panels for the SV 104BIS instruments are listed in the below Table. For detailed panel description follow Supervisor User Manual.

Icon	Name
	Session header
	Instrument configuration
	Logger results
	Total results
	Logger statistics
	Statistical results
	Logger spectrum results
	Time Intersection
	Spectrum results
	Text
	Hearing protectors / summary
	Noise exposure
	'What if'
	Map
	Wave

6.5.6 Generating reports from sessions

You can easily generate a report containing measurement data displayed in the same way as in the current session by clicking the  button, located on the Toolbar.

The report can be created in one of the following formats:

- DOC (if MS Word 2003 or newer is installed),
- PDF (if MS Word 2007 or newer is installed),
- RTF.

The generated file will contain a start page and all the contents of the panels (in the same order and with the same graphical settings).

All the reports created in the current session are listed in the *Reports* panel, located at the bottom-left corner of the window. By double-clicking a report's name, you can open it in MS Word.

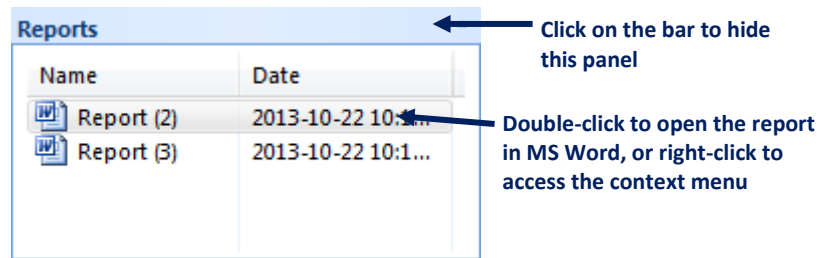



Figure 6-49 Reports panel

By right-clicking you can open a context menu allowing for opening, renaming and deleting reports.

The start page and the style of the report can be customized using the *Report options* dialog box, opened by clicking the  button. Instead of customizing the start page, you can also disable adding it to the reports at all.

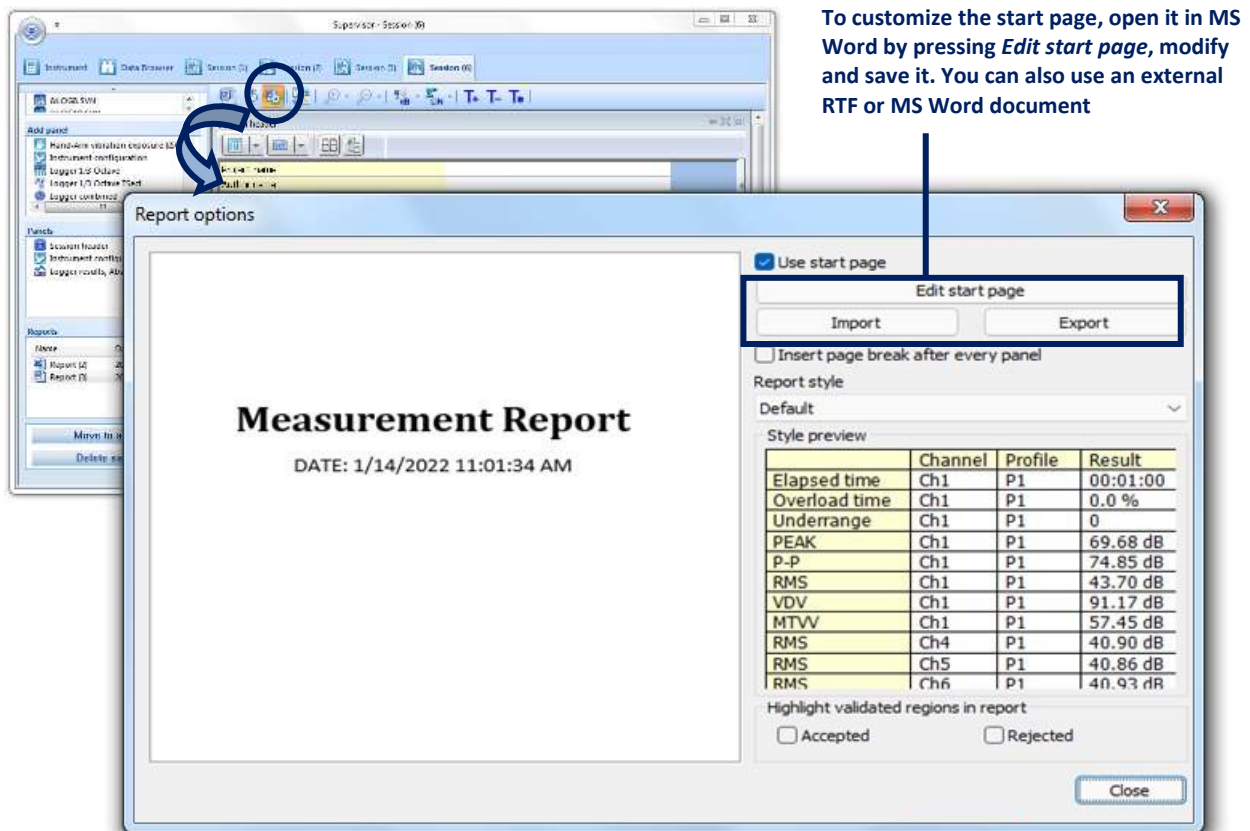


Figure 6-50 Report options dialog box

7 SV 104BIS MAINTENANCE

7.1 GENERAL RECOMMENDATIONS FOR USE

- Do not disassemble or modify the instrument. The battery inside contains safety and protective devices, which, if damaged, may cause the battery to generate heat, explode or ignite.
- It is not recommended to leave the instrument nor accessories in direct sunlight conditions for prolonged periods of time. Doing so may cause the battery contained inside to generate heat, explode, or ignite. Using the instrument in this manner may also result in a loss of performance and a shortened life expectancy.
- Do not keep the instrument for a long time discharged (see Chapter [7.7](#)).
- Charge the SV 104BIS instrument in a docking station before attempting to turn it on if the dosimeter has not been used for a prolonged period or was stored in a low battery state condition.
- To improve accuracy of remaining battery life indicator, run the dosimeter until it is fully discharged; then proceed with a full charge with use of the **SB 104B-5** or **SB 104B-1** docking station. The procedure is recommended before first use. Repeat this procedure year of use to maintain more accurate current battery condition indication.
- Use docking station charger only in a safe area.

7.2 CLEANING

Few things to remember:

- Every time SV 104BIS gets too dirty, clean the surface of the dosimeter with water damp soft cloth. Under no circumstances should this equipment be cleaned using a solvent based cleaner (it can affect the case polymeric materials).
- Pay special attention that the provided **SA 122BIS** windscreen is clean because dirtiness can affect the measurements. Take off the windscreen, shake off any dirt, and clean it with damp cloth. If necessary, change the windscreen to a new one. The foam windscreen is considered a consumable item and will need replacing if it becomes lost or its condition deteriorates too much. Packs of 3 replacement windscreens are available under the part number **SA 122BIS_3**.
- Pay special attention that the microphone front part is clean because dirtiness can affect the measurements. Avoid the small inlet hole getting too dirty. Clean carefully with a dry and soft non-fraying cloth.

7.3 IN SITU CALIBRATION

It is advised to perform an acoustic calibration of the instrument each time before and after the measurement run. A single calibration at the start of each day of use is usually sufficient for most regulations. See Chapter [4.7](#) for calibration details.



Note: With the use of the **SV 34B** calibrator the calibration can be performed only in a safe area.

7.4 PERIODIC TESTING

The manufacturer's recommended factory calibration interval is every **12 months** for SV 104BIS to be confident in its continuing accuracy and compliance with the international specifications.



Note: Please contact your local SVANTEK distributor for further details on traceable recalibrations that are recommended by most regulatory authorities.

7.5 CHANGING THE MICROPHONE AND WINDSCREEN



Note: Changing the microphone and/or windscreen is only allowed in a safe area.

In case the windscreen is destroyed/lost by any accident, or it gets too dirty to afford the microphone the best protection then SVANTEK offers **SA 122BIS_3** three pcs per pack (windscreens for the SV 104BIS dosimeter).

To change the microphone, unscrew the windscreen first (Chapter 3.3). Then unscrew the microphone protective sleeve and pull the microphone to extract it.

To attach a new microphone, insert the new microphone to the socket and screw the microphone protective sleeve on clockwise until it fits tightly. Be gently and be aware not to break or strip the thread. Then proceed to screw the windscreen until it stops firmly.



Note: When the microphone is changed, the new **microphone serial number** is automatically stored into the SV 104BIS internal memory.

7.6 FIRMWARE UPDATE

SVANTEK is committed to continuous innovation path of development, and as such reserves the right to provide firmware enhancements based on user's feedback.

To update the instrument firmware:



- Unpack the provided firmware package (provided as a suitable compressed file).
- Make sure the unit is turned off and is on the docking station, connected to a PC with the USB cable.
- Hold down the  key and press the  key to turn on the unit. This ensures the unit will switch on and enter the special reprogramming **BOOTSTRAP** mode.



Figure 7-1 BOOTSTRAP mode view

- Run the **start.bat** file.

- Successful firmware update will be indicated by relevant message.
- Turn off the unit.



Note: With use of **Supervisor** software it is very easy to check if there are any new firmware releases available for download (see [Figure 6-5](#) commands).

7.7 STORING THE INSTRUMENT

- To preserve the life of the internal batteries, it is recommended that the SV 104BIS instrument is turned off when it is stored.
- It is best not to store the dosimeter for any period of time in low battery state condition.
- Generally, the SV 104BIS instrument should be stored at room temperature, charged to about 40 to 60% of capacity.
- After use, it is best to charge SV 104BIS prior to storage for a prolonged period that is longer than 3 months.
- It is recommended to turn off the Bluetooth® interface in applied settings.
- If the dosimeter is to be stored for an even longer period, it is best to take the instrument out of storage and re-charge the dosimeter every 8 months. When SV 104BIS is turned off, it still draws a small amount of battery power, so periodic recharge is to prevent battery over-discharge.

7.8 TRANSPORTATION AND CARRYING

For transportation or storage purpose, always use the packaging provided by the manufacturer. In a potentially dirty industrial environment, it is advisable to use the carrying case provided by the manufacturer **SA 144**, which ensures excellent mechanical and environmental protection and long-term storage conditions. The temperature range over which the device can be stored/transported is -20°C to +50°C.



Note: For Air-transport Bluetooth® should be turned off !

7.9 TROUBLESHOOTING

1. Upon connection onto the docking station port, if automatic charging is not started: check the docking station LED colour for state of charging (Chapter [4.1](#)).
2. If the incorrect time or date is displayed when turning on the instrument connect the device to the computer and use **Supervisor** software to set the time and date (see) ensuring PC clock is set correctly.
3. In case the instrument is not able to turn on ensure the unit is charged by connecting onto the docking station. This ensures the battery is not exhausted. Then proceed with hardware reset (Chapter [4.17](#)).
4. In case your dosimeter does not respond proceed with turn-off/turn-on procedure (Chapter [4.3](#)), and hardware reset of the instrument (Chapter [4.17](#)).
5. In case the measurement of the sound level is frozen or set to a fixed value proceed with turn-off/turn-on procedure (Chapter [4.3](#)), then with hardware reset of the instrument (Chapter [4.17](#)).
6. In case the reset does not help proceed to Chapter [9](#).

8 RISK ASSESSMENT AND MITIGATION OF RISK

Electrical safety HAZARDS are fully addressed by 6-16 clauses of the IEC 61010-1.

Hazard locations related HAZARDS are fully addressed by IEC 60079-0 and IEC 61010-1.

For details see:

- GENERAL WARNINGS, SAFETY CLAUSES, AND STANDARD INFORMATION, page [3](#)
- HAZARDOUS AREA INSTALLATIONS SPECIFIC INFORMATION, page [4](#)
- SPECIAL PRECAUTIONS WHEN USING AND CHARGING LITHIUM BATTERIES, page [5](#)
- ENVIRONMENTAL PROTECTION MARKING OF THE UNIT, page [6](#)

HAZARDS related to reliable function, performance and wrong software setup are covered by:

- Chapter 4, RUNNING AND OPERATING BASIC PROCEDURES, page [33](#)
- Chapter 6, SUPERVISOR BASIC OPERATIONS, page [54](#)
- Chapter 7, SV 104BIS MAINTENANCE, page [87](#)

9 SVANTEK SERVICE

Should your SVANTEK professional measurement equipment need to be returned for repair or for calibration, please contact the service office at the following number or contact via the SVANTEK website.

Service Office: +48 (22) 51-88-320 or +48 (22) 51-88-322.

Office hours are 9:00 a.m. to 5:00 p.m. Central European Time.

E-mail: office@svantek.com.pl
support@svantek.com.pl

Internet: www.svantek.com

Address: SVANTEK Sp. z o.o.
Strzygłowska 81
04-872 Warszawa,
Poland



Note: International customers:

Contact your local authorized distributor from whom the product was purchased. You can obtain the name and contact information of your local authorized distributor from SVANTEK by using the e-mail or telephone information listed above or use our website to find nearest distributor office.

APPENDIX A REMOTE CONTROL

USB 2.0 interface is the serial one working with 480 MHz clock which enables one to control remotely the unit. Its speed is relatively high, and it ensures the common usage of USB in all produced nowadays Personal Computers.

The functions, which are developed in order to control data flow in the serial interfaces, ensure:

- Bi-directional data transmission,
- Remote control of the instrument.

The user, in order to program the serial interface, has to:

1. send "the function code",
2. send an appropriate data file or
3. receive a data file.

A.1 INPUT / OUTPUT TRANSMISSION TYPES

The following basic input / output transmission types (called functions) are available:

#1 input/output of the control setting codes,

- #2** read out of the measurement results in the **DOSE METER** mode,
- #3** read out of the measurement results in the **1/1 OCTAVE** or **1/3 OCTAVE** analysis mode,
- #4** read out of the data file from the internal Flash-disc or RAM memory,
- #5** read out of the statistical analysis results,
- #7** special control functions,
- #9** writing the data file into the internal flash-disk.
- #D** read/write the data file from the external memory (SD Card),

A.2 FUNCTION #1 - INPUT/OUTPUT OF THE CONTROL SETTING CODES

#1 function enables the user to send the control setting codes to the instrument and read out a file containing the current control state. A list of the control setting codes is given in Tab. A.1. The format of #1 function is defined as follows:

#1,Xccc,Xccc,(...),Xccc;

or

#1,Xccc,X?,Xccc,(...),X?,Xccc;

where:

X - the group code, **ccc** - the code value,

X? - the request to send the current X code setting.

The instrument outputs in this case a control settings file for all requests X? in the following format:

#1,Xccc,Xccc,(...),Xccc;

In order to read out all current control settings the user should send to the device the following sequence of characters:

#1;

The instrument outputs in this case a file containing all control settings given in Tab. A1 in the format:

#1,Xccc,Xccc,(...),Xccc;

Example: The instrument sends the following sequence of characters as an answer for the mentioned above request:

#1,U104,N12342,W1.08.1,Q0.01,M4,F2:1,F3:2,F1:3,J2:1,J3:2,J1:3,f1,C1:1,C0:2,C2:3,B0:1,B3:2,B15:3,b0,d1s,D10s,K5,L0:1,L0:2,L0:3,Y3,y0,XC115:1,XC115:2,XC115:3,XI115:1,XI115:2,XI115:3,S0,T1,e480,c1:1,c1:2,c1:3,h0:1,h0:2,h0:3,x3:1,x3:2,x5:3;

means that:

- SV 104BIS is investigated (U104);
- number is 12342 (N12342);
- software version number is 1.08.1 (W1.08.1);
- calibration factor is equal to 0.01 dB (Q0.01);
- **DOSE METER** is selected as the measurement function (M4);
- **A** filter is selected in profile 1 (F2:1);
- **C** filter is selected in profile 2 (F3:2);
- **Z** filter is chosen in profile 3 (F1:3);
- **A** Peak filter is selected in profile 1 (J2:1);
- **C** Peak filter is selected in profile 2 (J3:2);
- **Z** Peak filter is selected in profile 3 (J1:3);
- **Z** filter is selected for **1/1 OCTAVE** or **1/3 OCTAVE** analysis (f1)
- **FAST** detector is selected in profile 1 (C1:1);
- **IMPULSE** detector is chosen in profile 2 (C0:2);
- **SLOW** detector is selected in profile 3 (C2:3);
- logger's buffer is not filled by the results from profile 1 (B0:1);
- **PEAK** and **MAX** values are stored in the files of the logger from profile 2 (B3:2);
- **PEAK**, **MAX**, **MIN** and **LEQ** values are stored in the files of the logger from profile 3 (B15:3);
- results of **1/1 OCTAVE** analysis are not stored in the files of the logger (b0);
- results are stored in a logger's file every 1 second (d1s);
- integration period is equal to 10 seconds (D10s);
- measurement has to be repeated 5 times (K5);
- linear detector is selected to the **LEQ** calculations in profile 1 (L0:1);
- linear detector is selected to the **LEQ** calculations in profile 2 (L0:2);
- linear detector is selected to the **LEQ** calculations in profile 3 (L0:3);
- delay of the start of the measurements is equal to 3 seconds (Y3);
- synchronization the start of measurement with RTC is switched off (y0);
- threshold level for PTC calculation in profile 1, is set to 115 dB (XC115:1);
- threshold level for PTC calculation in profile 2, is set to 115 dB (XC115:2);
- threshold level for PTC calculation in profile 3, is set to 115 dB (XC115:3);
- threshold level for ULT calculation in profile 1, is set to 115 dB (XI115:1);
- threshold level for ULT calculation in profile 2, is set to 115 dB (XI115:2);
- threshold level for ULT calculation in profile 3, is set to 115 dB (XI115:3);
- instrument is in the Stop state (S0);
- logger is active (T1);
- exposition time is set to 8 hours (e480);
- criterion level in profile 1 is chosen as 80 dB (c1:1);

- criterion level in profile 2 is chosen as 80 dB (c1:2);
- criterion level in profile 3 is chosen as 80 dB (c1:3);
- threshold level in profile 1 is None (h0:1);
- threshold level in profile 2 is None (h0:2);
- threshold level in profile 3 is None (h0:3);
- exchange rate in profile 1 is set to 3 (x3:1).
- exchange rate in profile 2 is set to 3 (x3:2).
- exchange rate in profile 3 is set to 5 (x5:3).



Note: All bytes of that transmission are ASCII characters.

A.3 FUNCTION #2 - MEASUREMENT RESULTS READ-OUT IN DOSE METER MODE

#2 function enables one to read out the current measurement result from the selected profile in the **SLM** mode.



Note: This function can also be programmed while measurements are taking place. In this case, the LEQ values measured **after entering #2 function** are sent out.

#2 function has the format defined as follows:

#2 [,<aver>] [,<profile>] [[[,X?] ,X?] ,(…)] ;

where:

<aver> – type of results:

i – instantaneous results, i.e. results from the current cycle (default),

a – averaged results, i.e. results from the previous cycle.

<profile> – profile number:

1, 2 or 3 – one of the profile, i.e. only results from the given profile will be sent;

X – code of the specified result (see below); if no code are specified all results will be sent;



Note: After finishing the measurement, #2 function is no longer active and has to be reprogrammed in order to read-out successive measurements.

The instrument sends the values of results in the format defined as follows:

#2,p,Xccc,Xccc,Xccc,(…),Xccc; (where **p** - the number of the results set)

or

#2,?; (when the results are not available).

The codes of the results from the **DOSE METER** mode are defined as follows:

v the under-range flag (ccc equals to 0 when the overload did not occur, 2 when the under-range took place during the last measurement period but did not occur in the last second of the measurement and 3 when the under-range took place during the last measurement period and it lasted in the last second of the measurement);

V the overload flag (ccc equals to 0 or 1);

T	time of the measurement (ccc – value in seconds);
P	the Lpeak value (ccc – the value in dB);
M	the Lmax value (ccc – the value in dB);
N	the Lmin value (ccc – the value in dB);
S	the L result (ccc – the value in dB);
D	the DOSE result (ccc – the value in %);
d	the D_8h result (ccc – the value in %);
p	the PrDOSE result (ccc – the value in %);
A	the LAV result (ccc – the value in dB);
R	the Leq result (ccc – the value in dB);
U	the LE result (ccc – the value in dB);
u	the SEL8 result (ccc – the value in dB);
E	the E result (ccc – the value in Pa ² h);
e	the E_8h result (ccc – the value in Pa ² h);
I(nn)	the LEPd result (ccc – the value in dB, nn – the value of Exposure Time in minutes);
J	the PSEL result (ccc – the value in dB);
Y	the Ltm3 result (ccc – the value in dB);
Z	the Ltm5 result (ccc – the value in dB);
L(nn)	the value L of the nn statistics (ccc – the value in dB);
C	the PTC result (ccc – the counter value);
c	the PTP result (ccc – the value in %);
I	the ULT result (ccc – value in seconds);
W	the TWA result (ccc – the value in dB);
w	the PrTWA result (ccc – the value in dB);
a	the Lc-a result (ccc – the value in dB);
t	no motion time (ccc – value in seconds);

The exemplary results of the instrument's response after sending to it the following sequence of characters: **#2,1**; coming from the first profile are given below:

```
#2,1,v1,V0,T146,P89.47,M64.73,N46.90,S56.47,D0,d0,p0,A0.00,R50.56,U72.20,u95.15,E0.00,e0.00,I(4
80)50.57,J27.61,Y53.92,Z54.63,L(01)60.40,L(10)49.80,L(20)48.50,L(30)47.90,L(40)47.70,L(50)47.50,L(
60)47.30,L(70)47.10,L(80)46.80,L(90)46.40,C0,c0,I0,W-38.12,w0.01,a4.73,t0;
```



Note: The presented above order of the measurement results sent out by the instrument does not depend about the characters sent to the unit.

Example: After sending to the instrument the string:

```
#2,1,T?,R?,V?,P?,L?;
```

the unit sends out the results of measurement coming from the first profile in predefined, described above, order:

```
#2,1,V0,T146,P89.47,R50.56,L(01)60.40,L(10)49.80,L(20)48.50,L(30)47.90,L(40)47.70,L(50)47.50,L(60)
47.30,L(70)47.10,L(80)46.80,L(90)46.40;
```



Note: The value displayed on the screen during the result's presentation is sent out from the instrument in the case when **nn** is not given after **X** character.



Note: All bytes of that transmission are ASCII characters.

A.4 FUNCTION #3 - READ-OUT OF THE MEASUREMENT RESULTS IN 1/1 OCTAVE OR 1/3 OCTAVE MODE

#3 function enables one to read out the current measurement results in **1/1 OCTAVE** or **1/3 OCTAVE**

#3 function format is defined as follows:

#3;

The device responds, sending the last measured spectrum (when the instrument is in STOP state) or currently measured spectrum (when the instrument is in RUN state) in the following format:

**#3;<Status Byte> <LSB of the transmission counter> <MSB of the transmission counter>
<data byte> (...) <data byte>**

Status Byte gives the information about the current state of the instrument.

D7	D6	D5	D4	D3	D2	D1	D0
----	----	----	----	----	----	----	----

where:

- D7 = 0 means that "overload does not happen",
= 1 means that "overload appeared",
- D5 = 0 means that "spectrum is not averaged",
= 1 means that "spectrum is averaged",
- D4 = 0 the instantaneous current result (RUN State),
= 1 the final result (STOP State),
- D3 = 1 results in **1/3 OCTAVE** mode,
- D2 = 1 results in **1/1 OCTAVE** mode,
- D6, D3, D1, D0 reserved bits.



Note: The measurement result is coded in binary form as $\text{dB} \cdot 100$ (e.g. 34.5 dB is sent as binary number 3450).

A.5 FUNCTION #4 - READ-OUT OF THE DATA FILE FROM THE INTERNAL FLASH-DISK OR RAM MEMORY

#4 function enables the user to read-out the data file from the internal Flash-Disk or RAM memory. The data file formats are given in Appendix B.

#4 function formats are defined as follows:

- #4,0,\;** the file containing the catalogue,
- #4,0,?;** the count of the files,
- #4,0,index,count;** the part of the file containing the catalogue,

where:

- index** - first record,
- count** - number of records in the catalogue.

- #4,1,fname;** the file containing the measurement results,
- #4,1,fname,?;** file size,
- #4,1,fname,offset,length;** the part of the file containing the measurement results,

where:

fname - name containing not more than eight characters,
offset - offset from the beginning of the file,
length - number of bytes to read,

#4,4; the current settings file,
#4,4,?; size of the current settings file,
#4,4,offset,length; the part of current settings file,

where:

offset - offset from the beginning of the current settings file,
length - number of bytes to read.



Note: The "\" character is treated as the file name of the catalogue and must be sent to the instrument.

All data words are sent as <LSB>,<MSB>.

When an error is detected in the file specification or data, the instrument will send:

#4,?;

The catalogue of the files is a set of the records containing 16 words (16 bits each). Each record describes one file saved in the instrument's Flash-disc or RAM. The record structure is as follows:

words 0 - 3 8 characters of the file name,
 word 4 file type (binary number),
 word 5 reserved,
 word 6 the least significant word of the file size,
 word 7 the most significant word of the file size,
 words 8 - 15 reserved.

A.6 FUNCTION #5 - STATISTICAL ANALYSIS RESULTS READ-OUT

#5 function enables one to read out the statistical analysis results.

#5 function format is defined as follows:

#5,p;

where:

p - the number of the profile (1, 2 or 3)

The device responds, sending the current classes of the statistics in the following format:

**#5,p;<Status Byte> <LSB of the transmission counter> <MSB of the transmission counter>
 <NofClasses><BottomClass><ClassWidth><Counter of the class> (...) <Counter of the class>**

Status Byte gives the information about the current state of the instrument.

D7	D6	D5	D4	D3	D2	D1	D0
----	----	----	----	----	----	----	----

where:

D7 = 0 means "overload does not happen",

= 1 means "overload appeared",
 D6= 1 reserved,
 D5= 0 the instantaneous current result (RUN State),
 = 1 the final result (STOP State),
 D0 to D4 reserved bits.



Note: There is not any succeeding transmission in the case when the **Status Byte** is equal to zero.

The **transmission counter** is a two-byte word denoting the number of the remaining bytes to be transmitted. Its value is calculated from the formulae:

Transmission counter = 6+n * (4 * the number of the classes in the statistics)

where:

n is the number of the transmitted statistics. For $p = 1, 2$ or 3 only one statistic is transmitted ($n = 1$).

NofClasses is a two-byte word denoting the number of classes in the statistic.

BottomClass is a two-byte word denoting the lower limit of the first class (*10 dB).

ClassWidth is a two-byte word denoting the width of the class (*10 dB).

Counter of the class is a four-byte word containing the number of the measurements belonging to the current class.



Note: The bytes in the words are sent according to the scheme **<LSByte>..<MSByte>**.

A.7 FUNCTION #7 - SPECIAL CONTROL FUNCTIONS

#7 function enables the user to perform special control functions. **Some of them should be used with the extreme care.**

#7 function formats are defined as follows:

#7,AC;	This function returns auto calibration in the format #7,AC,x;
#7,AC,x;	This function enables ($x = 1$) or disables ($x = 0$) the auto calibration and returns the following sequence of characters: #7,AC; This function is not accepted while the instrument is in the RUN state.
#7,AP;	Reserved
#7,AR;	Reserved.
#7,AS;	Get settings for the Auto-Run function.

Response format: **#7,AS,e,HH,MM,hh,mm,dW,mR;**

where:

e	– On (e=1), Off (e=0),
HH	– hour of the measurement start,
MM	– minutes of the measurement start,
hh	– hour of the measurement stop,

- mm – minutes of the measurement stop,
 dW – day of week in which the measurement will be done:
 bit:0 – Monday,
 ...
 bit:6 – Sunday
 mR – maximum number of the measurement days,

#7,AS, e,HH,MM,hh,mm,dW,mR;

where:

- e – On (e=1), Off (e=0),
 HH – hour of the measurement start,
 MM – minutes of the measurement start,
 hh – hour of the measurement stop,
 mm – minutes of the measurement stop,
 dW – day of week in which the measurement will be done:
 bit:0 – Monday,
 ...
 bit:6 – Sunday
 mR – maximum number of the measurement days,

Response format: **#7,AS;**

This function is not accepted while the instrument is in the RUN state.

- #7,AV;** Reserved.
#7,BC; The function returns the battery charge level in [mAh].
#7,BD; The function returns the total battery discharge current in [mAh].
#7,BN; This function returns the number of logger files created to the current time in the format: **#7,BN,dddd;** (dddd - number of logger files in decimal format).
#7,BS; This function returns battery state in %.
#7,BP; This function returns the Bluetooth PIN number.

Response format: **#7,BT,nnnn;**

where: **n** – PIN number,

- #7,BP,nnnn;** This function sets the Bluetooth PIN number.

where: **n** – PIN number,

- #7,BT;** This function returns the state of the Bluetooth power.

Response format: **#7,BT,n;**

where: **n** 0 – Off
 1 – On,

- #7,BT,n;** This function sets the state of the Bluetooth power.

where: **n** 0 – Off
 1 - On,

#7,BV; This function returns battery voltage in 10 mV.

#7,CH; Get number of records calibration history

Response format: **#7,CH,n;**

where: **n** – number of records calibration history,

#7,CH,n; Get one record from calibration history.

where: **n** – record number in the history of calibration,

Response format: **#7,CH,n,cT,hh:mm:ss,DD/MM/YYYY,cF,cL;**

where: **n** – record number in the history of calibration,

cT – type of calibration:

0 - none,

1 - by measurement,

2 - by sensitivity,

3 - factory calibration,

hh:mm:ss – time of calibration,

DD/MM/YYYY – date of calibration,

cF – calibration factor.

cL – calibration level.

Response **#7,CH,-1;** denotes incorrect data in the selected record

#7,CS; This function restores the factory settings

This function is not accepted while the instrument is in the RUN state.

#7,CT; Get date and time of last calibration;

Response format: **#7,CT,DD-MM-YYYY,hh:mm:ss,;**

where: **hh:mm:ss** – time,

DD-MM-YYYY – date.

#7,DB; Reserved.

#7,DL; Reserved.

#7,DS,file_name; This function deletes setup file in SETUP directory specified by **file_name**.

This function is not accepted while the instrument is in the RUN state.

#7,ED; This function deletes all files on sd card. The function returns **#7,ED;**

This function is not accepted while the instrument is in the RUN state.

#7,EV; This function returns external power voltage in 10 mV.

#7,FF; This function returns Free Field compensation in the format **#7,FF,x;**

#7,FF,x; This function enables ($x = 1$) or disables ($x = 0$) the Free Field compensation and returns the following sequence of characters: **#7,FF;**

This function is not accepted while the instrument is in the RUN state.

#7,FS; This function returns file system version.

#7,FT;	This function returns file system on sd card in the format #7,FT,x ; where x denotes -1: no sd card, 2: FAT32.
#7,IC;	Reserved.
#7,KL,x;	This function locks ($x = 1$) or unlocks ($x = 0$) keyboard and returns the following sequence of characters: #7,KL ;
#7,KL;	This function returns the states of keyboard lock in the format #7,KL,x ;
#7,LA;	This function returns current language in the format: #7,LA,xx ; where xx is language codes: GE (German), EN (English), IT (Italian), PL (Polish), RU (Russian), HU (Hungarian), TU (Turkish), NL (Flemish), FR (French), SP (Spanish).
#7,LB;	This function returns the name of last logger in format #7,LB,logger_name ;
#7,LF;	This function restore Teds factory calibration. This function is not accepted while the instrument is in the RUN state.
#7,LS,setup_name;	This function loads setup and writes settings into EEPROM. The selected file must exist. The function returns #7,LS ; This function is not accepted while the instrument is in the RUN state.
#7,LT;	This function reloads microphone parameters from TEDS. This function is not accepted while the instrument is in the RUN state.
#7,LW;	This function returns the name of last wave file in format #7,LW,wave_file_name ;
#7,MC;	This function returns microphone compensation in the format #7,MC,x ;
#7,MC,x;	This function enables ($x = 1$) or disables ($x = 0$) the microphone compensation and returns the following sequence of characters: #7,MC ; This function is not accepted while the instrument is in the RUN state.
#7,NF;	This function returns number of free sectors on sd card (-1 denotes no sd card). Sector size is 512B.
#7,NS;	This function returns number of sectors on sd card (-1 denotes no sd card). Sector size is 512B.
#7,PE;	This function returns atmospheric pressure Response format: #7,PE,xx.x ; where: xx.x – atmospheric pressure in [hPa].
#7,PI;	This function returns PIC version.
#7,PN;	This function returns profile names
#7,PO;	This function powers off the instrument. This function is not accepted while the instrument is in the RUN state.
#7,RT;	This function returns current real time clock settings in the format: #7,RT,hh,mm,ss,DD,MM,YYYY ; where hh:mm:ss denotes the time and DD/MM/YYYY gives the date.
#7,RT,hh,mm,ss,DD,MM,YYYY;	This function sets the current real time clock and returns the following sequence of characters: #7,RT ; This function is not accepted while the instrument is in the RUN state.
#7,SC;	Reserved.
#7,SD;	Get date and time of last loaded setup file;

Response format: **#7,RT,hh,mm,ss,DD,MM,YYYY**;

 where: **hh:mm:ss** – time,

DD/MM/YYYY – date.

- #7,SE;** Reserved.
- #7,SF;** Reserved.
- #7,SL;** This function returns all statistical levels in the format **#7,SL,sl1,sl2,sl3,sl4,sl5,sl6,sl7,sl8,sl9,sl10;**
- #7,SL,sl_index,sl_level;** This function sets statistical levels where **sl_index** is the statistical index, **sl_level** is the statistical level and returns the following sequence of characters: **#7,SL;**
This function is not accepted while the instrument is in the RUN state.
- #7,SN;** Get last loaded setup file name;

Response format: **#7,SN,name;**

where: name – setup file name.

- #7,SP;** Reserved.
- #7,SS;** This function creates setup file based on the current settings. The function returns **#7,SS;**
This function is not accepted while the instrument is in the RUN state.
- #7,ST;** Get Standby Delay.

Response format: **#7,ST,xxx;**

where: xxx – time to standby in [s].

- #7,ST,x;** Set Standby Delay.
where: xxx – time to standby in [s].

Response format: **#7,ST;**

This function is not accepted while the instrument is in the RUN state.

- #7,TC;** This function returns TEDS calibration factor;
- #7,TF;** This function returns TEDS factory calibration factor;
- #7,TP;** Get temperature.

Response format: **#7,TP,xx.x;**

where: **xx.x** – temperature in [°C].

- #7,TS;** This function returns microphone serial number saved in TEDS memory.
- #7,TT;** This function returns type of microphone saved in TEDS memory. Value of -1 means unknown TEDS, value of 27 means SV27 microphone;
- #7,TU;** This function upload calibration factor to microphone's TEDS memory.
This function is not accepted while the instrument is in the RUN state.
- #7,UF;** This function returns USB speed in the format **#7,UF,x;**
- #7,UF,x;** This function sets USB full speed (12Mbps, x = 1) or sets usb high speed (480Mbps, x = 0) and returns the following sequence of characters: **#7,UF;**
This function is not accepted while the instrument is in the RUN state.
- #7,UN;** This function returns unit name;

#7,US;	This function returns unit subversion.
#7,UV;	This function returns USB voltage in 10 mV.
#7,VB;	This function returns the Bootstrap software version.
#7,VH;	This function returns the Hardboot software version. This function restart instrument.
#7,XR;	This function is not accepted while the instrument is in the RUN state.

For the unknown function and/or in the case of the other error, all these functions return the following sequence of characters: **#7,?;**

A.8 FUNCTION #9 - WRITE-IN THE DATA FILE INTO THE INTERNAL FLASH-DISC

#9 function enables the user to write-in the data file into the internal Flash-disc memory. The data file formats are given in Appendix B.

#9 function formats are defined as follows:

#9,FILE_TYPE,FILE_LENGTH,DATA

where:

FILE_TYPE	type of the file 2 - setup file, 4 - current settings file,
FILE_LENGTH	length of the file in bytes,
DATA	binary content of the file.

A.9 FUNCTION #D – READ / WRITE THE DATA FILES FROM THE EXTERNAL MEMORY (SD CARD)

<disk>	logical disk number: 0 – SD Card, 1 – USB Disk (not implemented), 2 – Internal Memory (not implemented)
<address>	directory address (cluster numer) – for internal memory 0
<offsetB>	offset the first byte to read (an even number).
<nB>	number of bytes to read (an even number)
<data>	binary data.
<count>	directory size in bytes
<name>	file name in format XXXXXXXX.YYY (XXXXXXX – file name, YYY- file name extension)
<dirName>	directory name
<nBwr>	number of bytes to write

- 1) #D,c,?; this function returns the list of available disks in format:
#D,c,<disk1>[,<disk2>[,<disk3>]];
- 2) #D,d,?; this function returns the parameters of the working directory in format:
#D,d,<disk>,<address>,<count>;
- 3) #D,d,<disk>,<address>; this function enables to change the working directory
Response:
#D,d; - command was executed
#D,d,?; - command cannot be executed
- 4) #D,r,<disk>,<address>,<offsetB>,<nB>; function enables the user to read the file (except of internal memory):
Response:
#D,r,<disk>,<address>,<offsetB>,<nB>; [<data>]
- 5) #D,w,<name>,<nBwr>;<data> function enables the user to write the file to working directory:
Response:
#D,w; - command was executed
#D,w,?; - command cannot be executed
- 6) #D,e,<name>; function enables the user to delete the file in working directory:
Response:
#D,e; - command was executed
#D,e,?; - command cannot be executed
- 7) #D,e; function enables the user to delete all files in in working directory:
Response:
#D,e; - command was executed
#D,e,?; - command cannot be executed
- 8) #D,m,<address>,<dirName>; function enables the user to create a subdirectory in the directory defined by <address>:
Response:
#D,m; - command was executed
#D,m,?; - command cannot be executed
- 9) #D,f,<address>; function enables the user to delete directory and its contents (files and subdirectories):
Response:
#D,f; - command was executed
#D,f,?; - command cannot be executed

A.10 CONTROL SETTING CODES

The control setting codes used in the SV 104BIS instrument (the internal software revision 1.07.1) are given in the table below.

Table A.1. Control setting codes

Group name	Group code	Code description
Unit type	U	U104 (read only)
Serial number	N	Nxxxx (read only)
Software version	W	Wyyy yyy - revision number (read only)
Calibration factor	Q	Qnnnn nnnn - real number with the value of the calibration factor $\in (-19.9 \div 19.9)$
Measurement function	M	M2 - 1/1 OCTAVE analyser M3 - 1/3 OCTAVE analyser M4 - DOSE METER
Filter type in profile n	F	F1:n - Z filter for profile n F2:n - A filter for profile n F3:n - C filter for profile n
Filter type for Peak result calculation in profile n	J	J1:n - Z filter for profile n J2:n - A filter for profile n J3:n - C filter for profile n
Detector type in profile n	C	C0:n - IMPULSE detector in profile n C1:n - FAST detector in profile n C2:n - SLOW detector in profile n
Filter type in 1/1 OCTAVE analysis	f	f1 - Z filter f2 - A filter f3 - C filter
Logger type in profile n	B	Bx:n - x - sum of the following flags flags: 1:n - logger with PEAK values in profile n 2:n - logger with MAX values in profile n 4:n - logger with MIN values in profile n 8:n - logger with LEQ values in profile n 16:n - logger with LAV values in profile n
Storing the results of 1/1 OCTAVE or 1/3 OCTAVE analysis in logger's file	b	bx - x - sum of the following flags flags: 8 - logger with LEQ values
Logger step	d	dnns - nn number in seconds $\in (1 \div 60)$ dnnm - nn number in minutes $\in (1 \div 60)$

Integration period	D	<p>D0 - infinity (measurement finished by pressing the Stop or remotely - by sending S0 control code)</p> <p>Dnns - nn number in seconds</p> <p>Dnnm - nn number in minutes</p> <p>Dnnh - nn number in hours</p>
Repetition of the measurement cycles (RepCycle)	K	<p>K0 - infinity (measurement finished by pressing the Stop or remotely - by sending S0 control code)</p> <p>Knnnn - nnnn number of repetitions $\in (1 \div 1000)$</p>
Detector type in the LEQ function in profile n	L	<p>L0:n - Linear detector for profile n</p> <p>L1:n - Exponential detector for profile n</p>
Exposure Time	e	ennn - nnn time in minutes $\in (1 \div 720)$
Criterion Level	c	<p>c1:p - 80 dB</p> <p>c2:p - 84 dB</p> <p>c3:p - 85 dB</p> <p>c4:p - 90 dB</p> <p>c5:p - 60 dB</p> <p>c6:p - 65 dB</p> <p>c7:p - 70 dB</p> <p>c8:p - 75 dB</p> <p>c9:p - 87 dB</p> <p>c10:p - 81 dB</p> <p>c11:p - 82 dB</p> <p>c12:p - 83 dB</p> <p>p: 1, 2, 3 - profile number</p>
Threshold Level	h	<p>h0:p - None</p> <p>h1:p - 70 dB</p> <p>h2:p - 75 dB</p> <p>h3:p - 80 dB</p> <p>h4:p - 85 dB</p> <p>h5:p - 90 dB</p> <p>h6:p - 60 dB</p> <p>h7:p - 65 dB</p> <p>p: 1, 2, 3 - profile number</p>
Exchange Rate	x	<p>x2:p - 2</p> <p>x3:p - 3</p> <p>x4:p - 4</p> <p>x5:p - 5</p>

		x6:p - 6 p: 1, 2, 3 - profile number
Logger	T	T0 - switched off ([]) T1 - switched on ([√])
Delay in the start of measurement	Y	Ynn - nn delay given in seconds $\in (0 \div 59)$ and $(60 \div 3600)$ with step 60s
Synchronization the start of measurement with RTC	y	y0 - switched off (OFF) y1 - synchronization to 1 min. y15 - synchronization to 15 min. y30 - synchronization to 30 min. y60 - synchronization to 1 hour.
State of the instrument (Stop, Start or Pause)	S	S0 - STOP S1 - START S2 - PAUSE
Threshold level for PTC calculation	XC	XCnnn:p - nnn level in dB $\in (70 \div 140)$ p: 1, 2, 3 - profile number
Threshold level for ULT calculation	XI	XInnn:p - nnn level in dB $\in (70 \div 140)$ p: 1, 2, 3 - profile number

APPENDIX B DATA FILE STRUCTURES

B.1 GENERAL STRUCTURE OF THE SV 104BIS FILE

Each file containing data from the SV 104BIS instrument consists of several groups of words. In the case of the SV 104BIS (the internal file system rev. 1.07), there are two different types of files containing:

- the results stored in the file in the instrument's logger (cf. App. B.2);
- setup data (cf. App. B.3).

Each file has the following elements:

- the SvanPC file header (cf. Tab. B.1.1)
- a file header (cf. Tab. B.1.2)
- the unit and internal software specification (cf. Tab. B.1.3)
- the calibration settings (cf. Tab. B.1.4)
- the user's text (a header) stored together with the measurement data (cf. Tab. B.1.5)
- the Unit text info (cf. Tab. B.1.24)
- the parameters and global settings, common for all profiles (cf. Tab. B.1.6)
- parameters for Time-domain signal recording (cf. Tab. B.1.9)
- parameters for Wave-file recording (cf. Tab. B.1.10)
- the special settings for profiles (cf. Tab. B.1.12)
- the display settings of the main results (cf. Tab. B.1.13)
- the header of the statistical analysis (cf. Tab. B.1.14)
- header of the file from the logger (cf. Tab. B.1.15)
- contents of the file from the logger (cf. Tab. B.1.16)
- header of the Summary Results Record (cf. Tab. B.1.25)
- the main results saved in Summary Results Record (cf. Tab. B.1.17)

The other elements of the file structure are not obligatory for each file type stated above. They depend on the file type (**DOSE METER**, **1/1 OCTAVE**, **1/3 OCTAVE** file from the logger) These elements are as follows:

- statistical levels (saved in Summary Results Record) (cf. Tab. B.1.18)
- 1/1 OCTAVE analysis results (saved in Summary Results Record) (cf. Tab. B.1.19)
- 1/3 OCTAVE analysis results (saved in Summary Results Record) (cf. Tab. B.1.20)
- the results of the statistical analysis (saved in Summary Results Record) (cf. Tab. B.1.21)
- the settings of the instrument saved in the setup file (cf. Tab. B.1.22)
- the file-end-marker (cf. Tab. B.1.23)

Below, all file structure groups are described separately in Tab. B.1.1 – Tab. B.1.23. The format used in the columns, named **Comment** with the square parenthesis ([xx, yy]), means the contents of the word with; **xx** is the most significant byte (MSB) and **yy** the lowest significant byte (LSB) of the word. The format 0xnxxx means that the xxxx is four-digit number in hexadecimal form.

Table B.1.1. SvanPC file header

Word number	Name	Comment
0..2	"SvanPC"	reserved
3	26	reserved
4	32	reserved
5	4	reserved
6..15	Reserved	reserved
...

Table B.1.2. File header

Word number	Name	Comment
0	0xnn01	[01, nn=header's length]
1..4	FileName	name of the file (8 characters)
5	Reserved	Reserved
6	CurrentDate	file creation date (cf. App. B.4)
7	CurrentTime	file creation time (cf. App. B.4)
8..13	Reserved	Reserved
...		...

Table B.1.3. Unit and software specification

Word number	Name	Comment
0	0xnn02	[02, nn=specification's length]
1	UnitNumberL	unit number (LSB word)
2	UnitType	type of the unit: 104
3	SoftwareVersion	software version: 107
4	SoftwareIssueDate	software issue date
5	DeviceMode	mode of the instrument
6	UnitSubtype	subtype of the unit: 7 - SV 104B 8 - SV 104BIS
7	FileSysVersion	file system version: 107
8	reserved	Reserved
9	SoftwareSubversion	software subversion: 1
10..11	MicrophoneSN	the serial number of the microphone 0 - undefined
12	UnitNumberH	unit number (MSB word)
...		...

Table B.1.4. Calibration settings

Word number	Name	Comment
0	0xnn47	[47, nn=header's length]
1	PreCalibrType	type of calibration performed prior to measurement: 0 - none 1 - BY MEASUREMENT 3 - FACTORY CALIBRATION
2	PreCalibrDate	date of calibration performed prior to measurement (cf. App. B.4)
3	PreCalibrTime	time of calibration performed prior to measurement (cf. App. B.4)
4	PreCalibrFactor	factor (*100 dB) of calibration performed prior to measurement
5	PreCalibrLevel	level (*100 dB) of calibration performed prior to measurement
6	PostCalibrType	type of calibration performed after the measurement: 0 - none 1 - BY MEASUREMENT 3 - FACTORY CALIBRATION 0xFFFF - Calibration not performed
7	PostCalibrDate	date of calibration performed after the measurement (cf. App. B.4)
8	PostCalibrTime	time of calibration performed after the measurement (cf. App. B.4)
9	PostCalibrFactor	factor (*100 dB) of calibration performed after the measurement
10	PostCalibrLevel	level (*100 dB) of calibration performed prior to measurement
...

Table B.1.5. USER's text

Word number	Name	Comment
0	0xnn03	[03, nn=specification's length]
1...	title text	the user's text (two characters in a word) finished with one or two null bytes

Table B.1.6. Parameters and global settings

Word number	Name	Comment
0	0xnn04	[04, nn=block's length]
1	MeasureStartDate	measure start date (cf. App. B.4)
2	MeasureStartTime	measure start time (cf. App. B.4)
3	DeviceFunction	device function: 2 - 1/1 OCTAVE analyser, 3 - 1/3 OCTAVE analyser, 4 - DOSE METER

4	MeasureInput	measurement input type: 2 - Microphone
5	Range	measurement range: 2 - SINGLE
6	UnitFlags	calibration flags: b0 - if set to 1: calibration coefficient is used b3 - if set to 1: overload occurred b7,b6,b5: type of the result Lden 000 – Lden result is not available 001 – Ld result 010 – Le result 011 – Lde result 100 – Ln result 101 – Lnd result 110 – Len result 111 – Lden result
7	RepCycle	repetition cycle: 0 - infinity nnnn - number of repetitions $\in(1 \div 1000)$
8	NofChannel	number of channels (1)
8	NofProf	number of profiles (3)
10	StartDelay	start delay time
11..12	IntTimeSec	integration time specified in seconds
13	InterfaceMode	reserved
14	LeqInt	reserved
15	SpectrumFilter	1/1 or 1/3 OCTAVE analysis filter: 1 - Z , 2 - A , 3 - C in other cases: Reserved
16	SpectrumBuff	1/1 or 1/3 OCTAVE logger: sum of the following flags: 8 - logger with Leq values in other cases: reserved
17	ExposureTime	exposure time: 1..720 (min)
18	Leq & Lav	the method of viewing results Leq and Lav 0 - Both 1 - Mutually exclusive (visibility depends of the EXCHANGE RATE parameter)
19	MicComp	compensating filter for microphones: 0 - switched off, 1 - switched on
20	UL Th. Level[1]	the 1 st profile threshold level for ULT calculation 70 ÷ 140 dB (*10)
21	UL Th. Level[2]	the 2 nd profile threshold level for ULT calculation 70 ÷ 140 dB (*10)
22	UL Th. Level[3]	the 3 rd profile threshold level for ULT calculation 70 ÷ 140 dB (*10)
23	PEAK Th. Level[1]	the 1 st profile threshold level for PTC calculation 70 ÷ 140 dB (*10)

24	PEAK Th. Level[2]	the 2 nd profile threshold level for PTC calculation 70 ÷ 140 dB (*10)
25	PEAK Th. Level[3]	the 3 rd profile threshold level for PTC calculation 70 ÷ 140 dB (*10)
26	CriterionLevel[1]	the 1 st profile criterion level (only DOSE METER): 60, 65, 70, 75, 80, 81, 82, 83, 84, 85, 87, 90 (*10 dB)
27	ThresholdLevel[1]	the 1 st profile threshold level (only DOSE METER): 0, 60, 65, 70, 75, 80, 85, 90 (*10 dB)
28	ExchangeRate[1]	the 1 st profile exchange rate (only DOSE METER): 2, 3, 4, 5, 6
29	CriterionLevel[2]	the 2 nd profile criterion level (only DOSE METER): 60, 65, 70, 75, 80, 81, 82, 83, 84, 85, 87, 90 (*10 dB)
30	ThresholdLevel[2]	the 2 nd profile threshold level (only DOSE METER): 0, 60, 65, 70, 75, 80, 85, 90 (*10 dB)
31	ExchangeRate[2]	the 2 nd profile exchange rate (only DOSE METER): 2, 3, 4, 5, 6
32	CriterionLevel[3]	the 3 rd profile criterion level (only DOSE METER): 60, 65, 70, 75, 80, 81, 82, 83, 84, 85, 87, 90 (*10 dB)
33	ThresholdLevel[3]	the 3 rd profile threshold level (only DOSE METER): 0, 60, 65, 70, 75, 80, 85, 90 (*10 dB)
34	ExchangeRate[3]	the 3 rd profile exchange rate (only DOSE METER): 2, 3, 4, 5, 6
35	MainResBuff	Summary results. Contents defined as a sum of: 0 - none 1 - Main Results 2 - Spectrum 4 - Spectrum MAX 8 - Spectrum MIN 16 - reserved 32 - Statistical levels 64 - Statistical analysis in profiles 128 - reserved
36	StartSync	Synchronization the start of measurement with RTC 0 - switched off. 1 - synchronization to 1 min. 15 - synchronization to 15 min. 30 - synchronization to 30 min. 60 - synchronization to 1 hour.
37	CalMic10	reserved
38	FreeField	Free Field compensating filter for microphones: 0 - switched off, 1 - switched on
39	ProfileMask	Active profiles. Contents defined as a sum of: 1 - 1 st profile 2 - 2 nd profile 4 - 3 rd profile
40	Pause[1]	Programmable pause no. 1.

41	PauseBegin[1]	The start time of the pause no. 1 in format 0xhhmm hh – hour mm – minute
42	PauseEnd[1]	The end time of the pause no. 1 in format 0xhhmm: hh – hour mm – minute
43	Pause[2]	Programmable pause no. 2.
44	PauseBegin[2]	The start time of the pause no. 2 in format 0xhhmm hh – hour mm – minute
45	PauseEnd[2]	The end time of the pause no. 2 in format 0xhhmm: hh – hour mm – minute
46	Pause[3]	Programmable pause no. 3.
47	PauseBegin[3]	The start time of the pause no. 3 in format 0xhhmm hh – hour mm – minute
48	PauseEnd[3]	The end time of the pause no. 3 in format 0xhhmm: hh – hour mm – minute
49	Pause[4]	Programmable pause no. 4.
50	PauseBegin[4]	The start time of the pause no. 4 in format 0xhhmm hh – hour mm – minute
51	PauseEnd[4]	The end time of the pause no. 4 in format 0xhhmm: hh – hour mm – minute
52	Pause[5]	Programmable pause no. 5.
53	PauseBegin[5]	The start time of the pause no. 5 in format 0xhhmm hh – hour mm – minute
54	PauseEnd[5]	The end time of the pause no. 5 in format 0xhhmm: hh – hour mm – minute
...		

Table B.1.10. Wave-file recording parameters

Word number	Name	Comment
0	0xnn2D	[2D, nn=block's length]
1	TriggerMode	trigger mode: 0 - OFF , 1 - recording whole measurement 2 - recording on trigger SLOPE+ 3 - recording on trigger SLOPE- 4 - recording on trigger LEVEL+ 5 - recording on trigger LEVEL- 6 - recording on trigger GRAD+ 7 - recording on trigger MANUAL

2	TriggerSource	source of the triggering signal: 0 - Leq(1) the Leq result from the first profile
3	TriggerLevel	level of triggering: 50 ÷ 136 dB (*10)
4	TriggerGrad	gradient of triggering: 1 dB/ms ÷ 100 dB/ms
5	TriggerPre	pretrigger time given in 10ms
6	TriggerPost	reserved
7	TriggerSampling	sampling frequency given in 10Hz
8	TriggerRecTime	recording time of single data block: 0 - recording to the end of measurement 1..28800 (sec)
9	TriggerStep	trigger period given in 0.1 ms. If zero Step is equal to logger time-step (cf. Tab. B.1.15)
10	TriggerFilter	filter type: 1 - Z , 2 - A , 3 - C
11	BitsPerSample	bits/sample: 16
12	Range	Full scale signal range in 0.01dB
13	Gain	Signal gain in dB
...		

Table B.1.12. Special settings for profiles

Word number	Name	Comment
0	0xnn05	[05, nn=block's length]
1	0x0307	[used_profile, profile's mask]
2	0xmm06	[06, mm=sub-block's length]
3	DetectorP[1]	detector type in the 1 st profile: 0 - IMP. , 1 - FAST , 2 - SLOW
4	FilterP[1]	filter type in the 1 st profile: 1 - Z , 2 - A , 3 - C

5	BufferP[1]	logger contents in the 1 st profile defined as a sum of: 0 - none, 1 - L_{xpeak}^1 2 - $L_{xy\max}^2$ 4 - $L_{xy\min}^2$ 8 - L_{xyeq}^{23} 16 - LAV
6	FilterPeakP[1]	filter type for Peak result calculation in the 1 st profile: 1 - Z , 2 - A , 3 - C
7	LeqInt[1]	detector's type in the Leq function (1 st profile): 0 - LINEAR , 1 - EXPONENTIAL
8	0xmm06	[06, mm=sub-block's length]
9	DetectorP[2]	detector type in the 2 nd profile: 0 - IMP. , 1 - FAST , 2 - SLOW
10	FilterP[2]	filter type in the 2 nd profile: 1 - Z , 2 - A , 3 - C
11	BufferP[2]	logger contents in the 2 nd profile defined as a sum of: 0 - none, 1 - L_{xpeak}^1 2 - $L_{xy\max}^2$ 4 - $L_{xy\min}^2$ 8 - L_{xyeq}^{23} 16 - LAV
12	FilterPeakP[2]	filter type for Peak result calculation in the 2 nd profile: 1 - Z , 2 - A , 3 - C
13	LeqInt[2]	detector's type in the Leq function (2 nd profile): 0 - LINEAR , 1 - EXPONENTIAL
14	0xmm06	[06, mm=sub-block's length]
15	DetectorP[3]	detector type in the 3 rd profile: 0 - IMP. , 1 - FAST , 2 - SLOW

16	FilterP[3]	filter type in the 3 rd profile: 1 - Z , 2 - A , 3 - C
17	BufferP[3]	logger contents in the 3 rd profile defined as a sum of: 0 - none, 1 - L_{xpeak}^1 2 - $L_{xy}max^2$ 4 - $L_{xy}min^2$ 8 - L_{xyeq}^{23} 16 - LAV
18	FilterPeakP[3]	filter type for Peak result calculation in the 3 rd profile: 1 - Z , 2 - A , 3 - C
19	LeqInt[3]	detector's type in the Leq function (3 rd profile): 0 - LINEAR , 1 - EXPONENTIAL
...		
¹ x - depends of the filter type for Peak result calculation in selected profile: A, C, Z (cf. Tab. B.1.12) ² x - depends of the filter type in selected profile: A, C, Z (cf. Tab. B.1.12) y - depends of the detector type in selected profile: I (imp.), F (fast), S (slow) (cf. Tab. B.1.12) ³ y - only for exponential detector's type (cf. Tab. B.1.6)		

Table B.1.13. Display settings of the main results

Word number	Name	Comment
0	0xnn48	[48, nn=header's length]
1	TIME	0 – TIME result not displayed, 1 - TIME result displayed
2	L_peak	0 – L_{xpeak}^1 result not displayed, 1 – L_{xpeak}^1 result displayed
3	L_max	0 – $L_{xy}max^2$ result not displayed, 1 – $L_{xy}max^2$ result displayed
4	L_min	0 – $L_{xy}min^2$ result not displayed, 1 – $L_{xy}min^2$ result displayed
5	L_	0 – L_{xy}^2 result not displayed, 1 – L_{xy}^2 result displayed
6	DOSE	0 – DOSE result not displayed, 1 - DOSE result displayed
7	D_8h	0 – D_8h result not displayed, 1 - D_8h result displayed
8	LAV	0 – LAV result not displayed, 1 - LAV result displayed
9	L_eq	0 – L_{xyeq}^{23} result not displayed, 1 – L_{xyeq}^{23} result displayed
10	L_E	0 – $L_{xy}E^{23}$ result not displayed, 1 - $L_{xy}E^{23}$ result displayed
11	SEL8	0 – SEL8 result not displayed, 1 - SEL8 result displayed
12	E	0 – E result not displayed, 1 – E result displayed
13	E_8h	0 – E_8h result not displayed, E_8h 1 - result displayed
14	Lden	Reserved
15	LEPd	0 – LEPd result not displayed, 1 - LEPd result displayed

16	PSEL	0 – PSEL result not displayed, 1 - PSEL result displayed
17	Ltm3	0 – Ltm3 result not displayed, 1 - Ltm3 result displayed
18	Ltm5	0 – Ltm5 result not displayed, 1 - Ltm5 result displayed
19	Ln	0 – Ln result not displayed, 1 - Ln result displayed
20	PTC	0 – PTC result not displayed, 1 - PTC result displayed
21	PTP	0 – PTP result not displayed, 1 - PTP result displayed
22	ULT	0 – ULT result not displayed, 1 - ULT result displayed
23	TWA	0 – TWA result not displayed, 1 - TWA result displayed
24	PrDOSE	0 – PrDOSE result not displayed, 1 - PrDOSE result displayed
25	PrTWA	0 – PrTWA result not displayed, 1 - PrTWA result displayed
26	LR15	Reserved
27	LR60	Reserved
28	LCA	0 – Lc-a result not displayed, 1 – Lc-a result displayed
29	OVL	0 – OVL result not displayed, 1 - OVL result displayed
30	NoMotion	0 – NoMotion result not displayed, 1 - NoMotion result displayed
...
¹	x	- depends of the filter type for Peak result calculation in selected profile: A, C, Z (cf. Tab. B.1.12)
²	x	- depends of the filter type in selected profile: A, C, Z (cf. Tab. B.1.12)
	y	- depends of the detector type in selected profile: I (imp.), F (fast), S (slow) (cf. Tab. B.1.12)
³	y	- only for exponential detector's type (cf. Tab. B.1.6)

Table B.1.14. Header of the statistical analysis

Word number	Name	Comment
0	0xnn09	[09, nn=block's length]
1	0x0307	[03=number of profiles, 07=active profiles mask]
2	0xmm0A	[0A, mm=sub-block's length]
3	NofClasses[1]	number of classes in the first profile (120)
4	BottomClass[1]	bottom class boundary (*10 dB) in the first profile
5	ClassWidth[1]	class width (*10 dB) in the first profile
6	0xmm0A	[0A, mm=sub-block's length]
7	NofClasses[2]	number of classes in the second profile (120)
8	BottomClass[2]	bottom class boundary (*10 dB) in the second profile
9	ClassWidth[2]	class width (*10 dB) in the second profile
10	0xmm0A	[0A, mm=sub-block's length]
11	NofClasses[3]	number of classes in the third profile (120)
12	BottomClass[3]	bottom class boundary (*10 dB) in the third profile
13	ClassWidth[3]	class width (*10 dB) in the third profile
...

Table B.1.15. Header of the file from the logger

Word number	Name	Comment
0	0xnn0F	[0F, nn=header's length]
1	BuffTSec	logger time step - full seconds part
2	BuffTMiliseC	logger time step - milliseconds part
3	LowestFreq	the lowest 1/1 OCTAVE or 1/3 OCTAVE frequency (*100 Hz)
4	NOctTer	number of 1/1 OCTAVE or 1/3 OCTAVE results
5	NOctTerTot	number of TOTAL values
6..7	BuffLength	logger length (bytes)
8..9	RecsInBuff	number of records in the logger
10..11	RecsInObserv	number of records in the observation period equal to: number of records in the logger + number of records not saved
12..13	AudioRecords	number of audio records in the logger
...



Note: The current logger time step in seconds can be obtained from the formulae:

$$T = \text{BuffTSec} + \text{BuffTMiliseC} / 1000$$

Table B.1.16. Contents of the file from the logger

Word number	Name	Comment
0..(BuffLength/2-1)		result#1, result#2, ... result#(BuffLength/2-1)

Table B.1.17. Main results (saved in Summary Results Record)

Word number	Name	Comment
0	0xnn07	[07, nn=block's length]
1	0x0307	[used_profile, profile's mask]
2	0xmm08	[08, mm=sub-block's length]
3..4	MeasureTime	time of the measurement
5	Result[1][1]	L_{xpeak}^1 value in the 1 st profile (*100 dB)
6	Result[1][2]	$L_{xyE^{23}}$ value in the 1 st profile (*100 dB)
7	Result[1][3]	maximal value ($L_{xy\max}^2$) in the 1 st profile (*100 dB)
8	Result[1][4]	minimal value ($L_{xy\min}^2$) in the 1 st profile (*100 dB)
9	Result[1][5]	L_{xy}^2 value in the 1 st profile (*100 dB)

10	Result[1][6]	L_{xyeq}^{23} value in the 1 st profile (*100 dB)
11	Result[1][7]	Lc-a (LCeq-LAeq) value (*100 dB)
12	Result[1][8]	Ltm3 value in the 1 st profile (*100 dB)
13	Result[1][9]	Ltm5 value in the 1 st profile (*100 dB)
14	Result[1][10]	LAV value in the 1 st profile (*100 dB)
15	Result[1][11]	TLAV value in the 1 st profile (*100 dB)
16	UnderRes[1]	under-range value in the 1 st profile
17..18	ULTime[1]	ULT value in the 1 st profile (sec.)
19..20	PTC[1]	PTC value in the 1 st profile
21	UnitFlags	flags word for measurement cycle (definition in table B.1.6)
22	0xmm08	[08, mm=sub-block's length]
23..24	OVL	overlad time
25	Result[2][1]	L_{xpeak}^1 value in the 2 nd profile (*100 dB)
26	Result[2][2]	L_{xyE}^{23} value in the 2 nd profile (*100 dB)
27	Result[2][3]	maximal value ($L_{xy\max}^2$) in the 2 nd profile (*100 dB)
28	Result[2][4]	minimal value ($L_{xy\min}^2$) in the 2 nd profile (*100 dB)
29	Result[2][5]	L_{xy}^2 value in the 2 nd profile (*100 dB)
30	Result[2][6]	L_{xyeq}^{23} value in the 2 nd profile (*100 dB)
31	Result[2][7]	reserved
32	Result[2][8]	Ltm3 value in the 2 nd profile (*100 dB)
33	Result[2][9]	Ltm5 value in the 2 nd profile (*100 dB)
34	Result[2][10]	LAV value in the 2 nd profile (*100 dB)
35	Result[2][11]	TLAV value in the 2 nd profile (*100 dB)
36	UnderRes[2]	under-range value in the 2 nd profile
37..38	ULTime[2]	ULT value in the 2 nd profile (sec.)
39..40	PTC[2]	PTC value in the 2 nd profile
41	UnitFlags	flags word for measurement cycle (definition in table B.1.6)
42	0xmm08	[08, mm=sub-block's length]
43..44	NoMotion	No Motion Time (sec.)
45	Result[3][1]	L_{xpeak}^1 value in the 3 rd profile (*100 dB)
46	Result[3][2]	L_{xyE}^{23} value in the 3 rd profile (*100 dB)
47	Result[3][3]	maximal value ($L_{xy\max}^2$) in the 3 rd profile (*100 dB)
48	Result[3][4]	minimal value ($L_{xy\min}^2$) in the 3 rd profile (*100 dB)
49	Result[3][5]	L_{xy}^2 value in the 3 rd profile (*100 dB)
50	Result[3][6]	L_{xyeq}^{23} value in the 3 rd profile (*100 dB)

51	Result[3][7]	reserved
52	Result[3][8]	Ltm3 value in the 3 rd profile (*100 dB)
53	Result[3][9]	Ltm5 value in the 3 rd profile (*100 dB)
54	Result[3][10]	LAV value in the 3 rd profile (*100 dB)
55	Result[3][11]	TLAV value in the 3 rd profile (*100 dB)
56	UnderRes[3]	under-range value in the 3 rd profile
57..58	ULTime[3]	ULT value in the 3 rd profile (sec.)
59..60	PTC[3]	PTC value in the 3 rd profile
61	UnitFlags	flags word for measurement cycle (definition in table B.1.6)
...
¹	x - depends of the filter type for Peak result calculation in selected profile: A, C, Z (cf. Tab. B.1.12)	
²	x - depends of the filter type in selected profile: A, C, Z (cf. Tab. B.1.12) y - depends of the detector type in selected profile: I (imp.), F (fast), S (slow) (cf. Tab. B.1.12)	
³	y - only for exponential detector's type (cf. Tab. B.1.6)	

Table B.1.18. Statistical levels (saved in Summary Results Record)

Word number	Name	Comment
0	0xnn17	[17, nn=block's length]
1	0xpprr	[pp=used_profile, rr=profile's mask]
2	N_stat_level	number of statistical levels = N
3+i*(pp+1)	nn[i]	number of the Lnn statistics; i=0..N-1
3+i*(pp+1)+p	Lnn[i,p]	value of the Lnn statistics for profile p (p=1..pp) (*100 dB)
...

Table B.1.19. 1/1 OCTAVE analysis results (saved in Summary Results Record)

Word number	Name	Comment
0	0xnn0E, 0xnn27 0xnn26,	[block_id, nn=block_length] 0xnn0E - averaged spectrum results, 0xnn26 - min. spectrum results, 0xnn27 - max. spectrum results
1	0x0101	[used_profile, profile's mask]
2	LowestFreq	the lowest 1/1 OCTAVE frequency (*100 Hz): 3150 (AUDIO BAND)
3	NOct	number of 1/1 OCTAVE values: 9 (AUDIO BAND)

4	NOctTot	number of TOTAL values: 3
5÷20	Octave[i]	1/1 octave[i] value (*100 dB); $i=1\div\text{NOct}+\text{NoctTot}$ (1÷13)
...

Table B.1.20. 1/3 OCTAVE analysis results (saved in Summary Results Record)

Word number	Name	Comment
0	0xnn10, 0xnn29 0xnn28,	[block_id, nn=block_length] 0xnn10 - averaged spectrum results, 0xnn28 - min. spectrum results, 0xnn29 - max. spectrum results
1	0x0101	[used_profile, profile's mask]
2	LowestFreq	the lowest 1/3 OCTAVE frequency (*100 Hz): 2000 (AUDIO BAND)
3	NTer	number of 1/3 OCTAVE values: 28 (AUDIO BAND)
4	NTerTot	number of TOTAL values: 3
5÷50	Tercje[i]	1/3 octave[i] value (*100 dB); $i=1\div\text{NTer}+\text{NTerTot}$ (1÷34)
...

Table B.1.21. Results of the statistical analysis in profiles (saved in Summary Results Record)

Word number	Name	Comment
0	0x010B	[0B, prof_mask#1]
1	SubblockLength	2 * number of classes in the first profile + 2
2..3	Histogram[1][1]	the first counter in the first profile
4..5	Histogram[1][2]	the second counter in the first profile
.....
0	0x020B	[0B, prof_mask#2]
1	SubblockLength	2 * number of classes in the second profile + 2
2..3	Histogram[2][1]	the first counter in the second profile
4..5	Histogram[2][2]	the second counter in the second profile
.....
0	0x040B	[0B, prof_mask#3]
1	SubblockLength	2 * number of classes in the third profile + 2
2..3	Histogram[3][1]	the first counter in the third profile
4..5	Histogram[3][2]	the second counter in the third profile
.....

Table B.1.22. SETUP file

Word number	Name	Comment
0	0x0020	[20, 00=block's length in the second word]
1	BlockLength	length of the block
2..BlockLength-1	SetupTextData	saved setup values

Table B.1.23. File-end-marker

Word number	Name	Comment
0	0xFFFF	file end marker

Table B.1.24. Unit text info

Word number	Name	Comment
0	0xnn58	[58, nn=block's length]
1	"UN"	Unit name header
2..8	UnitName	Unit name
9	"SE"	Setup name header
10..14	SetupName	Setup name
15	"P1"	1 st profile name header
16..20	ProfileName[1]	1 st profile name
21	"P2"	2 nd profile name header
22..26	ProfileName[2]	2 nd profile name
27	"P3"	3 rd profile name header
28..32	ProfileName[3]	3 rd profile name
.....

Table B.1.25. Header of the Summary Results Record (saved in Summary Results Record)

Word number	Name	Comment
0	0xnn59	[59, nn=header's length]
1..2	RecNumber	Summary Results Record number: 1..
...

B.2 STRUCTURE OF THE FILE CONTAINING RESULTS FROM LOGGER'S FILE

SvanPC file header - cf. Tab. B.1.1.

File header - cf. Tab. B.1.2.

Unit and software specification - cf. Tab. B.1.3.

Calibration settings - cf. Tab. B.1.4.

USER'S text - cf. Tab. B.1.5.

Unit text info - cf. Tab. B.1.24.

Parameters and global settings - cf. Tab. B.1.6.

Wave-file recording parameters - cf. Tab. B.1.10.

Special settings for profiles - cf. Tab. B.1.12.

Display settings of the main results - cf. Tab. B.1.13.

Header of the statistical analysis - cf. Tab. B.1.14.

Header of the file from the logger - cf. Tab. B.1.15.

Contents of the file from the logger - cf. Tab. B.1.16. and the description in B.2.1.

B.2.1 The contents of the files in the logger

The records with the results and the records with the state of the markers as well as the records with the breaks in the results registration are saved in the files in the logger. All results are written in dB*100.

B.2.1.1 Record with the results

The contents of the record with the results depends on the selected measurement function and the value set in the **LOGGER** position of the **PROFILE x** and **SPECTRUM** sub-lists. The following elements can be present (in the given sequence):

- flag record

< flags > :

- b0: 1- the overload detected, 0 - the overload not detected

- b1: 1- the excessive self-vibration detected, 0 - the excessive self-vibration not detected

- b2: 1- the No Motion detected, 0 - the No Motion not detected

- results of the measurement from the first profile if the corresponding **LOGGER** position was active (BufferP [1] in Tab. B.1.12); up to five words are written:

<result1> - L_{xpeak}^1 result, depending on the value of BufferP[1] (cf. Tab. B.1.12)

<result2> - $L_{xy\max}^2$ result, depending on the value of BufferP[1] (cf. Tab. B.1.12)

<result3> - $L_{xy\min}^2$ result, depending on the value of BufferP[1] (cf. Tab. B.1.12)

<result4> - L_{xyeq}^{23} result, depending on the value of BufferP[1] (cf. Tab. B.1.12)

<result5> - **LAV** result, depending on the value of BufferP[1] (cf. Tab. B.1.12)

- results of the measurement from the second profile if the corresponding **LOGGER** position was active (BufferP [2] in Tab. B.1.12); up to five words are written:

<result1> - L_{xpeak}^1 result, depending on the value of BufferP[2] (cf. Tab. B.1.12)
 <result2> - $L_{xy\max}^2$ result, depending on the value of BufferP[2] (cf. Tab. B.1.12)
 <result3> - $L_{xy\min}^2$ result, depending on the value of BufferP[2] (cf. Tab. B.1.12)
 <result4> - L_{xyeq}^{23} result, depending on the value of BufferP[2] (cf. Tab. B.1.12)
 <result5> - **LAV** result, depending on the value of BufferP[2] (cf. Tab. B.1.12)

- (4) results of the measurement from the third profile if the corresponding **LOGGER** position was active (BufferP [3] in Tab. B.1.12); up to five words are written:

<result1> - L_{xpeak}^1 result, depending on the value of BufferP[3] (cf. Tab. B.1.12)
 <result2> - $L_{xy\max}^2$ result, depending on the value of BufferP[3] (cf. Tab. B.1.12)
 <result3> - $L_{xy\min}^2$ result, depending on the value of BufferP[3] (cf. Tab. B.1.12)
 <result4> - L_{xyeq}^{23} result, depending on the value of BufferP[3] (cf. Tab. B.1.12)
 <result5> - **LAV** result, depending on the value of BufferP[3] (cf. Tab. B.1.12)

1	x - depends of the filter type for Peak result calculation in selected profile: A, C, Z (cf. Tab. B.1.12)
2	x - depends of the filter type in selected profile: A, C, Z (cf. Tab. B.1.12) y - depends of the detector type in selected profile: I (imp.), F (fast), S (slow) (cf. Tab. B.1.12)
3	y - only for exponential detector's type (cf. Tab. B.1.6)

- (5) results of **1/1 OCTAVE** analysis or **1/3 OCTAVE** analysis if **1/1 OCTAVE** analysis or **1/3 OCTAVE** analysis was selected as the measurement function and the **LOGGER** was active (SpectrumBuff in Tab. B.1.6);
 the sequence of words is written:

<Octave Leq[1]> <Octave Leq[2]> ... <Octave Leq[NOct+NOctTot]>

where:

Octave Leq[i] - the result of **1/1 OCTAVE** or **1/3 OCTAVE** Leq analysis (*100 dB);
 i = 1..NOct+NOctTot

B.2.1.2 Record with the state of the markers

The record with the state of the markers consists of one word:

<0x8nnn>

in which 12 bits nnn denote the state of the markers:

b11 = state of #12 marker

b10 = state of #11 marker

...

b1 = state of #2 marker

b0 = state of #1 marker

B.2.1.3 Record with the breaks in the results registration

The record with the breaks in the results registration consists of four words:

<0xB0ii> <0xB1jj> <0xB2kk> <0xB3nn>

in which ii, jj, kk, nn bytes denote 4-bytes counter of left or skipped records: nnkkjjii (ii is the least significant byte, nn – the most significant byte).

B.2.1.4 Record with the breaks account PAUSE in the results registration

The record with the breaks in the results registration consists of four words:

<0xA0ii> <0xA1jj> <0xA2kk> <0xA3nn>

in which ii, jj, kk, nn bytes denote 4-bytes counter duration of PAUSE in milliseconds: nnkkjjii (ii is the least significant byte, nn - the most significant byte).

B.2.1.5 Record with the wave file name

The record with the wave file name consists of six words:

<0xC2aa>

<0xccbb>

<0xeedd>

<0xggff>

<0xiihh>

<0xCAaa>

in which:

aa - size of records,

bb cc dd ee ff gg hh ii - 8-bytes name of wave file name

B.2.1.6 Record with Summary Results

The format of the data frame is as follows:

HS	L (optional)	D	L (optional)	HE
----	--------------	---	--------------	----

where:

HS starting header (1 word)

L length of the block (field is optional and occurs only when b7..b0 in header are set to zero)

D Summary Data:

- Header of the Summary Results Record (cf. Tab. B.1.25)

- Main results (cf. Tab. B.1.17)

- Statistical levels (optional, cf. Tab. B.1.18)

- 1/1 OCTAVE analysis results (optional, cf. Tab. B.1.19)

- 1/3 OCTAVE analysis results (optional, cf. Tab. B.1.20)

- The results of the statistical analysis in profiles(optional, cf. Tab. B.1.21)

HE ending header (1 word), which differs from the HS only on b11 bit (thanks to it, it is possible to analyse the recorded file starting from its end)

The HEADER format is as follows:

b15	b14	b13	b12	b11	b10	b9	b8	b7	b6	b5	b4	b3	b2	b1	b0
-----	-----	-----	-----	-----	-----	----	----	----	----	----	----	----	----	----	----

where:

b15 - 1

b14 - 1

b13 - 0

b12 - 0,

b11 - header type:

0 - HS

1 - HE

b10 - 0

b9 - 1

b8 - 1

b15÷b8 – HS (0xC3), HE (0xCB)

b7÷b0 – length of the block (if zero length of the block is saved in additional word L)

B.2.1.8 Record with name of the comment file

The format of the data frame is as follows:

HS	D	HE
----	---	----

where:

HS starting header (1 word)

D The full name of the comment file (e.g. "REC62.WAV").

HE ending header (1 word), which differs from the HS only on b11 bit (thanks to it, it is possible to analyse the recorded file starting from its end)

The HEADER format is as follows:

b15	b14	b13	b12	b11	b10	b9	b8	b7	b6	b5	b4	b3	b2	b1	b0
-----	-----	-----	-----	-----	-----	----	----	----	----	----	----	----	----	----	----

where:

b15 - 1

b14 - 1

b13 - 0

b12 - 0,

b11 - header type:

0 - HS

1 - HE

b10 - 1

b9 - 0

b8 - 0

b15÷b8 – HS (0xC4), HE (0xCC)

b7÷b0 – length of the block

B.3 Structure of the SETUP file

SvanPC file header - cf. Tab. B.1.1.

File header - cf. Tab. B.1.2.

Unit and software specification - cf. Tab. B.1.3.

SETUP DATA - cf. Tab. B.1.22.

File-end-marker - cf. Tab. B.1.23.

B.4 Date and time

Following function written in C explain how the date and time are coded:

```
void ExtractDateTime(int date, unsigned int time, int dt[])
{
    dt[0] = time % 30;           /* sec */
    dt[1] = (time/30) % 60;     /* min */
    dt[2] = time/1800;          /* hour */

    dt[3] = date & 0x001F;      /* day */
    dt[4] = (date>>5) & 0x000F; /* month */
    dt[5] = (date>>9) & 0x007F + 2000; /* year */
}
```

APPENDIX C TECHNICAL SPECIFICATIONS

C.1 SPECIFICATION OF SV 104BIS AS DOSIMETER

C.1.1 Specification of SV 104BIS as dosimeter in standard configuration

Statement of performance

The SV 104BIS dosimeter meets also requirements of the: IEC 61252 ed1.2 (2017)

SV 104BIS dosimeter with all listed below accessories meets requirements of IEC 61672-1:2013 for Class 2 Group X instruments.

SV 104BIS dosimeter meets also requirements of the next standards: ANSI/ASA S1.25-1991 (R2017), IEC 61010-1 (2010), ANSI/UL 61010-1 and CAN/CSA C22.2 No 61010-1; ATEX/IECEX: IEC 60079-0 ed7.0 (2017), IEC 60079-11 ed6.0 (2011), CAN/CSA C22.2 No 60079-0, CAN/CSA C22.2 No 60079-11, ANSI/UL 60079-0, ANSI/UL 60079-11.

Certificate numbers

- IECEx FTZU 20.0014X
- FTZU 19 ATEX 0120X
- ANZEx 22.2003X

Hazardous area installations specific information

SV 104BIS marking per ATEX/IECEX: I M1 Ex ia I Ma, II 1G Ex ia IIC T4 Ga, $-10^{\circ}\text{C} < T_{\text{amb}} < +50^{\circ}\text{C}$,

Ingress protection: IP65

Maximum charge input voltage: $U_m=8.0\text{V}$

Intrinsic safety standards that SV 104BIS complies with:

- EN IEC 60079-0:2018, EN 60079-11:2012, EN 60079-26:2015, EN 50303:2000
- IEC 60079-0 ed7.0 (2017), IEC 60079-11 ed6.0 (2011), IEC 60079-26 ed3 (2014)

The dedicated charging docking stations are **SB 104B-1** or **SB 104B-5**.



Note: The equipment shall only be charged in non-hazardous area by manufacturer's chargers on a fireproof surface.

Configuration of the complete SLM and with its normal mode of operation:

SV 104BIS dosimeter/analyser including ST 104B microphone (1/2", nominal sensitivity 1 mV/Pa, polarization 0 V) and SA 122BIS windscreen

Recommended calibrator

SV 34B Class 2 acoustic calibrator 114 dB@1000 Hz or equivalent (not included in the standard set)

Accessories included in SV 104BIS instrument set

ST 104B	½ MEMS microphone
SA 122BIS	windscreen

Measured quantities

The measured quantities for *DOSE METER* mode are: **Time, Lpeak, Lmax, Lmin, SPL (L), DOSE, D_8h, PrDOSE, Lav, Leq, SEL (LE), SEL8, E, E_8h, LEPd, PSEL, Ltm3, Ltm5, Leq** statistics (**Ln**), **PTC, PTP, ULT, TWA, PrTWA, Lc-a**. Definitions for measured quantities are given in Appendix D.

Conformance testing

This chapter contains the information needed to conduct conformance testing according to the specified standards.

Mounting for acoustical tests

The microphone must be mounted on the instrument.

Electrical substitute for the microphone

To obtain a BNC Class electrical input, the microphone must be replaced by an electrical microphone impedance adapter SC 104AT **before turning the instrument on**. Total microphone substitute impedance is 125 Ω.



Note: The recommended time interval for periodic test of noise exposure meter for checking its acoustic and electrical working characteristics is one year.



Note: For the conformance electrical tests the **Microphone Compensation** must be disabled (see Chapter [4.15](#)).



Note: For the conformance acoustical tests with the microphone the **Microphone Compensation** must be enabled (see Chapter [4.15](#)).

For the comparison coupler evaluation, the **Free Field** compensation must be disabled.

For the free filed evaluation, the **Free Filed** compensation must be enabled.

Linear Operating Ranges

The starting point at which tests of level linearity shall begin is 114.0 dB for the frequencies specifies below.

Linear operating range for the sinusoidal signal and microphone sensitivity 1 mV/Pa

Single measuring range – see table below.

Table C.1 Linear operating ranges for Leq

[dB]	LAS/F		LCS/F		LZS/F		LAeqT		LCeqT		LAE (<i>t</i> _{int} = 2 s)		LCpeak	
	from	to	from	to	from	to	from	to	from	to	from	to	from	to
31.5 Hz	53	100.6	55	137	65	138	53	100.6	53	137	53	103.6	56	140
500 Hz	53	136.8	55	140	65	138	53	136.8	53	140	53	139.8	56	143
1 kHz	53	140	55	140	65	138	53	140	53	140	53	143	56	143
4 kHz	53	141	55	139.2	65	138	53	141	53	139.2	53	144	56	142.2
8 kHz	53	138.9	55	137	65	138	53	138.9	53	137	53	141.9	56	141



Note: For the signals with the crest factor $n > 1.41$ upper measuring range of the RMS (**LEQ** and **SPL**) is reduced. The valid upper limit can be calculated according to the below given formula:

$A_n = 140 - 20 \log(n/\sqrt{2})$, where **A** is the upper limit for the sinusoidal signal

Example: For the crest factor $n = 10$ the upper limit is **A₁₀ = 123 dB**

Measurement frequency range of the acoustic pressure (-3 dB): 20 Hz – 10000 Hz

Basic measurement error of the acoustic pressure	< 1 dB (measured for the reference conditions, see below).
Noise exposure values displayed range	0.01 Pa ² h ÷ 99.99 Pa ² h
Noise exposure values displayed resolution	0.01 Pa ² h



Note: Instrument can measure wider Sound Exposure (**E**) range than displayed. Based on the measured **Leq (dB)** value and exposure time **T (h)**, $E = p\sigma^2 T (10^{0.1 \times L_{Aeq}, T})$

Example: For the **L_{Aeq} = 124 dB** and **T = 1h** exposure value **E = 1004 Pa²h**

Weighting filters

Z meeting requirements of the IEC 61672-1:2013 standard for the Class 1 “**Z**” filter

A meeting requirement of the IEC 651 and IEC 61672-1:2013 standard for the Class 1 “**A**” filter

C meeting requirements of the IEC 651 and IEC 61672-1:2013 standard for the Class 1 “**C**” filter

Self-generated noise (electrical)

“ A ” weighting	< 42 dB
“ C ” weighting	< 41 dB
“ Z ” weighting	< 50 dB

Self-generated noise (acoustical compensated)

“ A ” weighting	< 46 dB
“ C ” weighting	< 48 dB
“ Z ” weighting	< 58 dB

RMS detector

Digital	“True RMS” with Peak detection,
Resolution	0.1 dB
Range	327.7 dB
Crest Factor	unlimited (for signals in 8 kHz bandwidth).

Overload detector

The instrument has the built-in overload detectors. Both A/D converter and input amplifier overload conditions are detected. The overload in the measurement channel (in its analogue part) and the overload of the

analogue / digital converter are both detected. The “overload” indication appears when the input signal amplitude is 0.5 dB above the declared “Peak measurement range”.

Underrange detector

The instrument has the built-in under-range detector. The “underrange” indication appears when the RMS value for the elapsed time is below the lower linear operating range.

Time weighting characteristics (Exponential averaging)

Slow	“S” according to IEC 61672-1:2013 Class 2, Equivalent Time Constant 1000 ms
Fast	“F” according to IEC 61672-1:2013 Class 2, Equivalent Time Constant 125 ms
Impulse	“I” according to IEC 61672-1:2013 Class 2, Equivalent Time Constant 35 ms, Hold Time 1500 ms

Reference conditions as per IEC 61252

Class of the acoustic field	Free field
Reference acoustic pressure	114.0 dB (related to 20 µPa)
Reference integration time	1 min
Reference noise exposure level	1.67 Pa ² h
Reference frequency	1000 Hz
Reference temperature	+20°C
Reference relative humidity	65 %
Reference static pressure	1013 hPa
Reference incidence direction	perpendicular to the microphone diaphragm

Calibration

Acoustical - with the **SV 34B** sound calibrator (or equivalent):

- Calibration level for the pressure field 114.0 dB (equal to the calibrator pressure level - see calibration chart of the used calibrator)
- Calibration level for the Free Field 113.87 dB (equal to the calibration level for the pressure field minus Free Field correction of ST 104B at 1000 Hz - see Table C.1.3)



Note: The above levels correspond to 114 dB of calibrator’s sound pressure. If the calibrator has a different sound pressure than 114 dB, the calibration levels must be accordingly adjusted.

Maximum peak voltage 3 V Peak-Peak

Maximum peak voltage of input sinusoidal signal, which can be led to the electrical input without destruction to the meter.

Warm-up time: 1 minute (for 0.1 dB accuracy)

Typical stabilization time after change the temperature in environmental conditions by 20°C is 1 hour.

Nominal delay 1 second

Delay between operating of the "Reset-Button" and beginning of a new measurement.

Time shift after completion of a measurement, before a measurement is shown: < 1 second.



Note: When the instrument is moved from a warm environment with high humidity, to a colder environment, care should be taken to avoid condensation inside the instruments. In such case, much longer stabilization periods may be necessary.

Environmental, electrostatic and radio frequency criteria

Effect of humidity < 0.5 dB (for 30%<RH<90% at 40°C and 1000 Hz)

Effect of magnetic field meets requirements of IEC 61252 p.12.5 (below electrical noise level for 80 A/m @ 50/60 Hz)

The maximum susceptibility (the least immunity) is achieved when in the Dosimeter the **Z** filter and time weighting **F** are selected, and the dosimeter measurements are considered.

The maximum susceptibility is achieved when the dosimeter is placed in plane of the magnetic field test coil, so the vertical axis of dosimeter is in parallel with wiring of the test frame (Fig. C.1).

In addition, with microphone cable, the maximum susceptibility is achieved when the dosimeter and cable is placed along field and the cable is coil as solenoid.

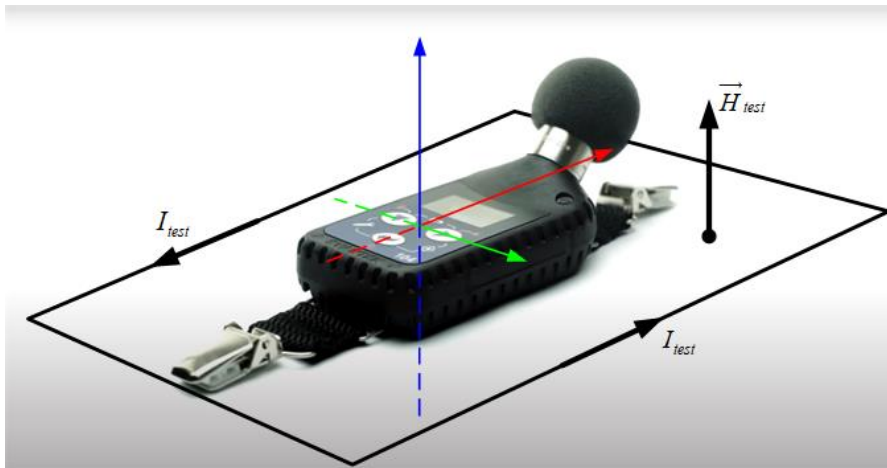


Figure C.1 SV 104BIS placed in magnetic field test coil in the direction of maximum response

Effect of radio frequency fields meets requirements of IEC 801-3:1984

Dosimeter use is allowed in the presence of an electromagnetic field whose source does not exceed the level of:

- a) 10 V/m in the frequency range from 80 MHz to 1000 MHz,
- b) 3 V/m in the frequency range from 1000 MHz to 6000 MHz.

Limitations of use: according to IEC 801-3 or IEC 1000-4-3 or EN 61000-4-3

Effect of electrostatic discharge meets requirements of IEC 801-2:1984

Dosimeter can be used without interrupting the continuity of operation, without changing the operating mode and configuration, without corruption or loss of the stored data, in presence of electrostatic discharge, the source of which does not exceed the level of:

- a) +/- 4 kV for contact discharge,
- b) +/- 8 kV for air discharge.

Limitations of use: according to IEC 801-2 or IEC 1000-4-2 or EN 61000-4-2

Effect of ambient pressure compensated within the range 65 ÷ 108 kPa

Effect of temperature range < 1.0 dB (from -10°C to +50°C)

Effect of vibration

For mechanical vibration with an acceleration of 1 m/s² vertically to the membrane of the microphone for the frequencies 31,5 Hz, 63 Hz, 125 Hz, 250 Hz, 500 Hz, 630 Hz, 800 Hz and 1000 Hz **increases the low level of the linear operation range to 70 dB for the frequency weighting "A"**.

For mechanical vibration with an acceleration of 1 m/s² parallel to the membrane of the microphone for the frequencies 31,5 Hz, 63 Hz, 125 Hz, 250 Hz, 500 Hz, 630 Hz, 800 Hz and 1000 Hz **increases the low level of the linear operation range to 80 dB for the frequency weighting "A"**.

Operating temperature range from -10°C to +50°C

Storage temperature range from -20°C to +50°C

Charging temperature range from 0°C to +40°C

Microphone

ST 104B	MEMS type (½" housing)
Nominal sensitivity	1 mV/Pa (corresponding to app. -60 dBV/Pa re 1 V/Pa)
Impedance	350 Ohm
Static pressure coefficient	0.02 dB/kPa



Note: Maximum sound pressure level that can affect the microphone without destroying the microphone: 160 dB.

ST 104B and SV 104BIS frequency characteristics

The instrument should be mounted so that the microphone diaphragm is perpendicular to the direction of the sound wave.

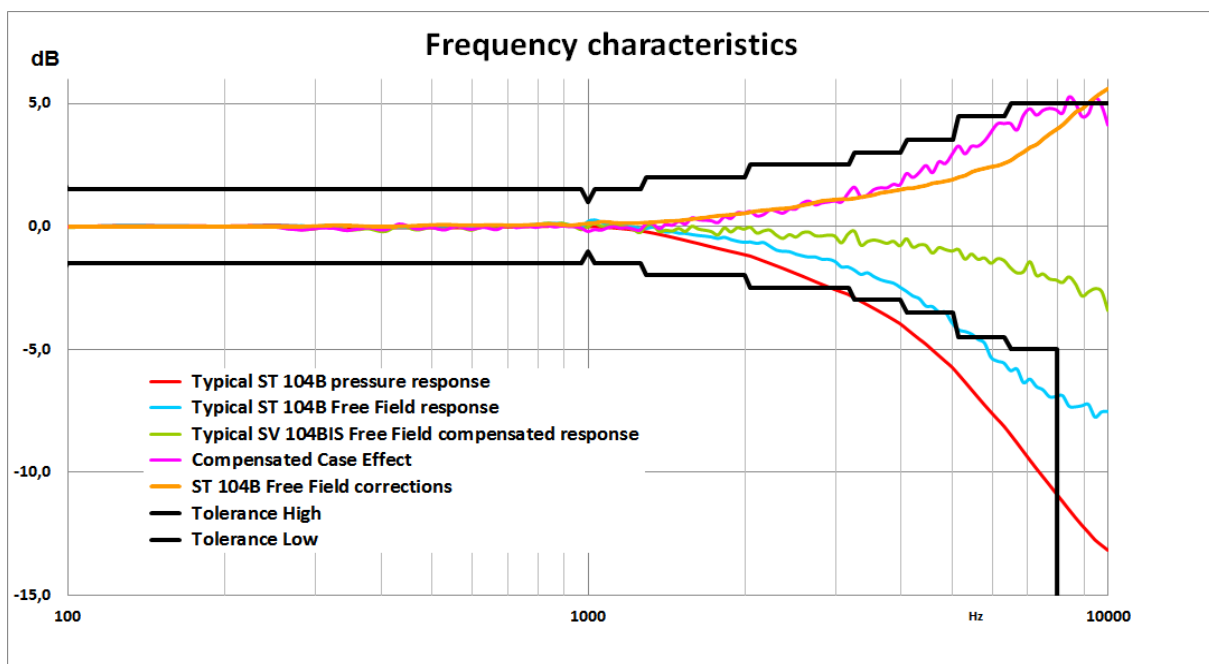


Figure C.2 SV 104BIS frequency characteristics

Table C.2 ST 104B Free Field corrections with the use of the Bruel & Kjaer 4226 sound calibrator

[dB]	Frequency [Hz]								
	31.5	63	125	250	500	1000	2000	4000	8000
Uncertainty (IEC 62585:2012)	0.25	0.25	0,25	0.25	0.25	0.25	0.25	0.25	0.35
ST 104B Free Field corrections	0.00	0.00	0.00	0.00	0.00	0.13	0,54	1.50	3.94

Table C.3 Typical ST 104B and SV 104BIS frequency characteristics

Frequency [Hz]	ST 104B Free Field response [dB]	SV 104BIS Free Field compensated response [dB]	Compensated case effect [dB]	Uncertainty (IEC 62585:2012) [dB]
20	-0.74	-0.78	-0.04	0.25
25	-0.13	-0.17	-0.04	0.25
32	0.00	-0.04	-0.04	0.25
40	0.04	0.00	-0.04	0.25
50	0.03	-0.02	-0.04	0.25
63	0.03	-0.01	-0.04	0.25
79	0.02	-0.02	-0.04	0.25
100	0.01	-0.03	-0.04	0.25
126	0.04	0.01	-0.04	0.25
158	0.03	0.00	-0.03	0.25
200	0.03	0.00	-0.02	0.25
251	0.04	-0.01	-0.05	0.25
259	0.04	-0.04	-0.08	0.25
266	0.04	-0.08	-0.12	0.25
274	0.03	-0.11	-0.14	0.25
282	0.04	-0.12	-0.16	0.25
290	0.02	-0.11	-0.13	0.25
299	0.02	-0.09	-0.11	0.25
307	0.03	-0.04	-0.07	0.25
316	0.07	-0.01	-0.08	0.25
325	0.06	-0.03	-0.09	0.25
335	0.04	-0.10	-0.14	0.25
345	0.03	-0.15	-0.18	0.25
355	0.01	-0.13	-0.14	0.25
365	0.00	-0.11	-0.11	0.25
376	0.00	-0.08	-0.07	0.25
387	-0.03	-0.12	-0.09	0.25
398	-0.04	-0.19	-0.15	0.25
410	-0.04	-0.19	-0.14	0.25
422	-0.03	-0.05	-0.02	0.25
434	-0.03	0.06	0.09	0.25
447	-0.03	0.01	0.04	0.25
460	-0.03	-0.10	-0.08	0.25
473	0.00	-0.13	-0.12	0.25
487	0.01	-0.07	-0.08	0.25

Frequency	ST 104B Free Field response	SV 104BIS Free Field compensated response	Compensated case effect	Uncertainty (IEC 62585:2012)
[Hz]	[dB]	[dB]	[dB]	[dB]
501	0.03	-0.02	-0.05	0.25
516	0.03	-0.09	-0.12	0.25
531	0.04	-0.11	-0.15	0.25
546	0.04	-0.02	-0.06	0.25
562	0.03	0.01	-0.01	0.25
579	0.00	-0.07	-0.08	0.25
596	-0.01	-0.14	-0.13	0.25
613	0.02	-0.07	-0.09	0.25
631	0.05	0.00	-0.05	0.25
649	0.06	-0.04	-0.10	0.25
668	0.06	-0.08	-0.14	0.25
688	0.03	0.01	-0.02	0.25
708	0.04	0.06	0.03	0.25
729	0.05	-0.01	-0.06	0.25
750	0.05	0.03	-0.02	0.25
772	0.07	0.06	-0.01	0.25
794	0.10	0.04	-0.05	0.25
818	0.12	0.12	0.01	0.25
841	0.13	0.14	0.01	0.25
866	0.14	0.10	-0.04	0.25
891	0.13	0.14	0.01	0.25
917	0.09	0.07	-0.02	0.25
944	0.02	0.00	-0.02	0.25
972	-0.03	-0.12	-0.09	0.25
1000	0.21	0.00	-0.21	0.25
1029	0.28	0.13	-0.14	0.25
1059	0.19	0.03	-0.16	0.25
1090	0.08	0.01	-0.07	0.25
1122	0.12	0.10	-0.02	0.25
1155	0.10	0.02	-0.08	0.25
1189	0.03	-0.03	-0.06	0.25
1223	0.01	-0.11	-0.12	0.25
1259	-0.08	-0.24	-0.17	0.25
1296	-0.07	0.04	0.11	0.25
1334	-0.01	0.07	0.09	0.25
1372	-0.09	-0.20	-0.11	0.25
1413	-0.21	-0.14	0.07	0.25
1454	-0.20	-0.17	0.03	0.25
1496	-0.26	-0.07	0.19	0.25
1540	-0.27	-0.19	0.08	0.25
1585	-0.32	0.02	0.34	0.25
1631	-0.36	-0.09	0.26	0.25
1679	-0.38	-0.14	0.24	0.25
1728	-0.42	-0.20	0.22	0.25
1778	-0.48	-0.34	0.14	0.25
1830	-0.43	-0.05	0.38	0.25
1884	-0.52	-0.21	0.31	0.25
1939	-0.59	-0.04	0.55	0.25

Frequency	ST 104B Free Field response	SV 104BIS Free Field compensated response	Compensated case effect	Uncertainty (IEC 62585:2012)
[Hz]	[dB]	[dB]	[dB]	[dB]
1995	-0.63	-0.10	0.53	0.25
2054	-0.62	-0.02	0.60	0.25
2113	-0.68	-0.26	0.41	0.25
2175	-0.64	-0.17	0.47	0.25
2239	-0.79	-0.14	0.66	0.25
2304	-0.95	-0.35	0.60	0.25
2371	-1.00	-0.47	0.53	0.25
2441	-1.01	-0.32	0.69	0.25
2512	-1.11	-0.42	0.70	0.25
2585	-1.18	-0.24	0.94	0.25
2661	-1.23	-0.22	1.02	0.25
2738	-1.23	-0.37	0.86	0.25
2818	-1.32	-0.38	0.95	0.25
2901	-1.32	-0.34	0.98	0.25
2985	-1.41	-0.38	1.02	0.25
3073	-1.63	-0.65	0.98	0.25
3162	-1.63	-0.31	1.33	0.25
3255	-1.77	-0.18	1.58	0.25
3350	-1.94	-0.75	1.19	0.25
3447	-1.87	-0.60	1.27	0.25
3548	-2.03	-0.54	1.49	0.25
3652	-2.15	-0.59	1.56	0.25
3758	-2.23	-0.67	1.56	0.25
3868	-2.29	-0.59	1.70	0.25
3981	-2.45	-0.77	1.68	0.25
4097	-2.63	-0.49	2.14	0.35
4217	-2.81	-0.83	1.98	0.35
4340	-2.93	-0.74	2.19	0.35
4467	-3.23	-0.76	2.47	0.35
4597	-3.24	-1.07	2.17	0.35
4732	-3.47	-0.85	2.62	0.35
4870	-3.48	-0.93	2.55	0.35
5012	-3.91	-0.99	2.92	0.35
5158	-4.19	-0.93	3.26	0.35
5309	-4.26	-1.32	2.94	0.35
5464	-4.36	-1.11	3.25	0.35
5623	-4.58	-1.32	3.25	0.35
5788	-4.73	-1.27	3.46	0.35
5957	-5.31	-1.48	3.82	0.35
6131	-5.46	-1.30	4.16	0.35
6310	-5.54	-1.37	4.17	0.35
6494	-5.85	-1.67	4.18	0.35
6683	-5.78	-1.87	3.91	0.35
6879	-6.33	-1.83	4.51	0.35
7079	-6.19	-1.42	4.77	0.35
7286	-6.50	-1.98	4.51	0.35
7499	-6.63	-1.92	4.71	0.35
7718	-6.91	-2.12	4.79	0.35

Frequency [Hz]	ST 104B Free Field response [dB]	SV 104BIS Free Field compensated response [dB]	Compensated case effect [dB]	Uncertainty (IEC 62585:2012) [dB]
7943	-6.90	-2.16	4.74	0.35
8175	-6.86	-2.27	4.60	0.35
8414	-7.29	-2.04	5.25	0.35
8660	-7.32	-2.32	5.00	0.35
8913	-7.27	-2.81	4.46	0.35
9173	-7.23	-2.65	4.58	0.35
9441	-7.74	-2.52	5.22	0.35
9716	-7.53	-2.62	4.91	0.35
10000	-7.51	-3.40	4.11	0.35

Table C.4 SV 104BIS combined Free Field corrections (ST 104B + Case Effect)

[dB]	Frequency [Hz]								
	31.5	63	125	250	500	1000	2000	4000	8000
Uncertainty (IEC 62585:2012)	0.35	0.35	0.35	0.35	0.35	0.35	0.35	0.35	0.49
SV 104BIS Free Field corrections	0.00	0.00	0.00	0.00	0.00	0.00	1.07	3.18	8.68

Directional characteristics of SV 104BIS

Directional response for dosimeter SV 104BIS with microphone **ST 104B** and **SA 122BIS** windscreen (symmetrical axis) for specified frequencies (Table C.5):

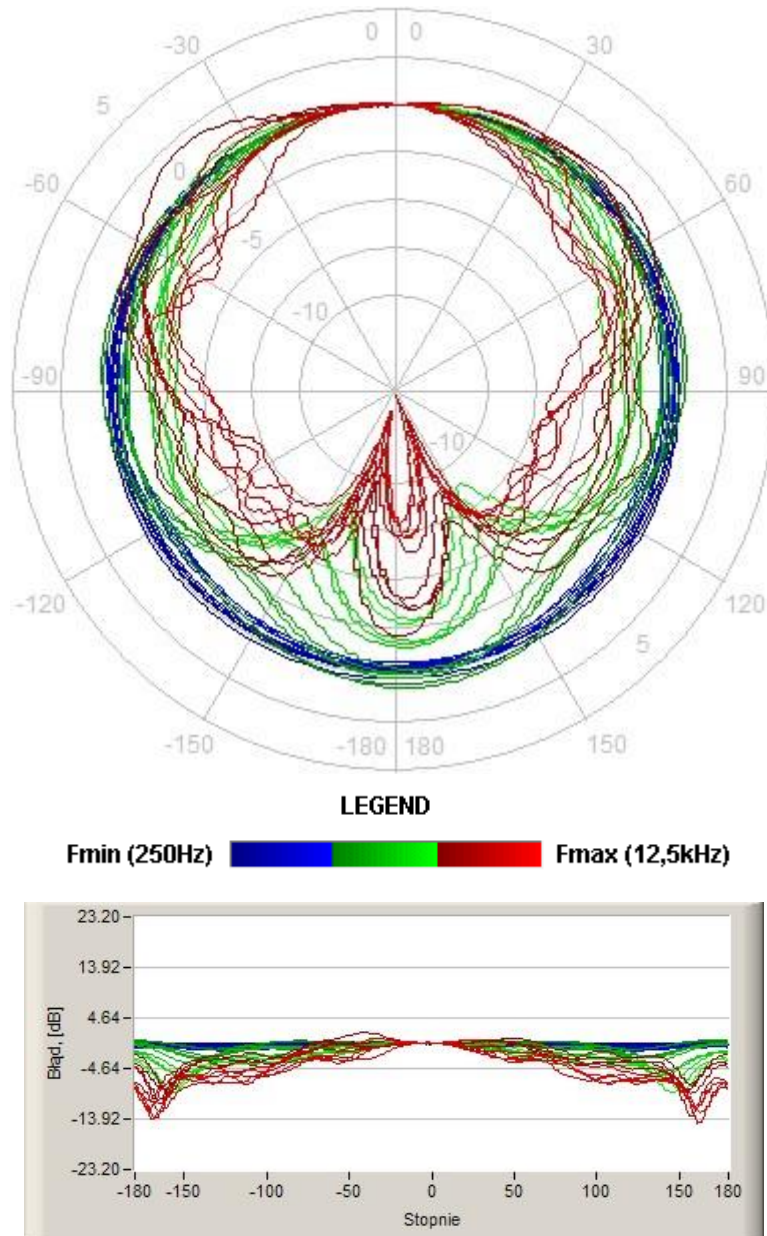
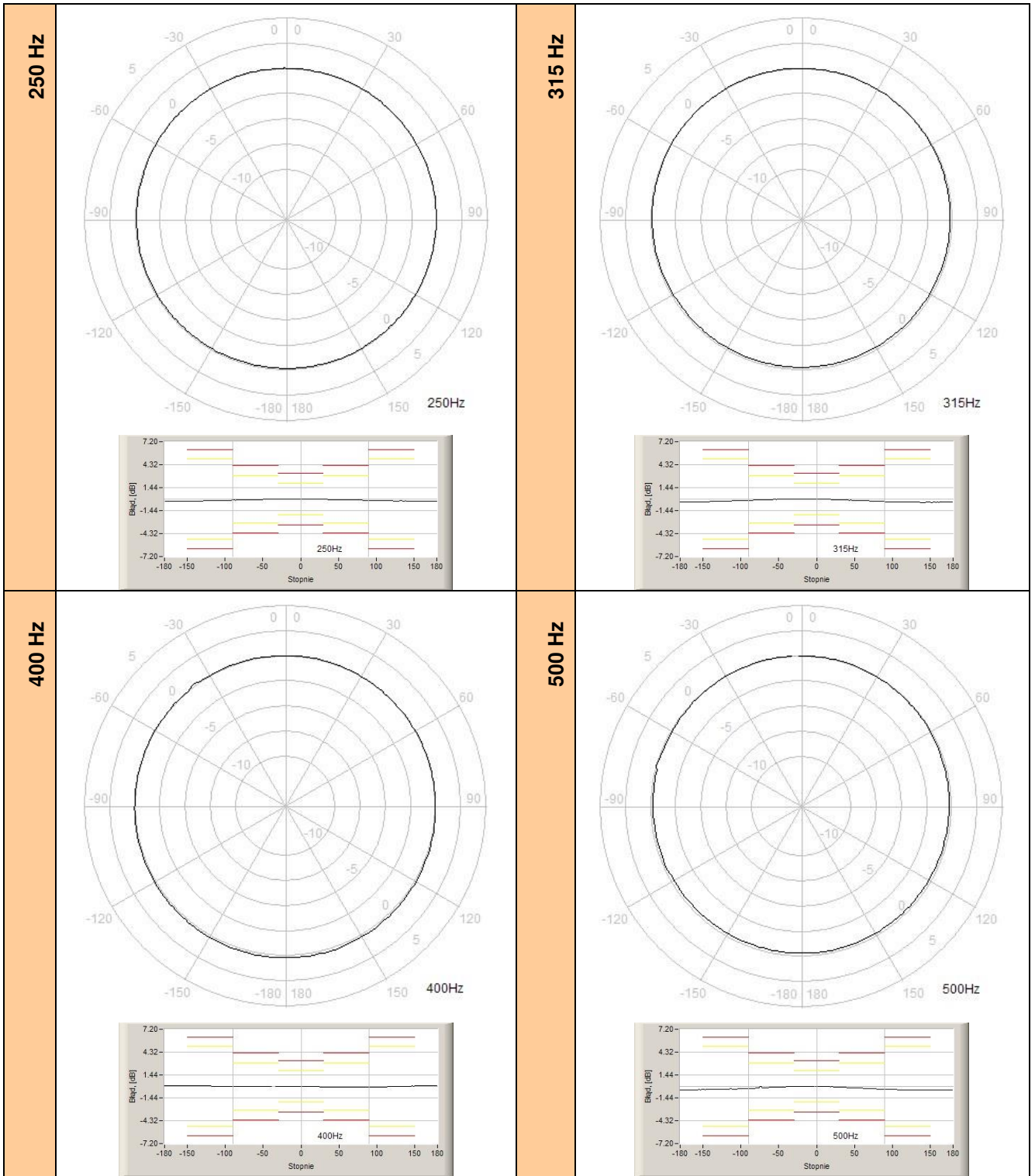
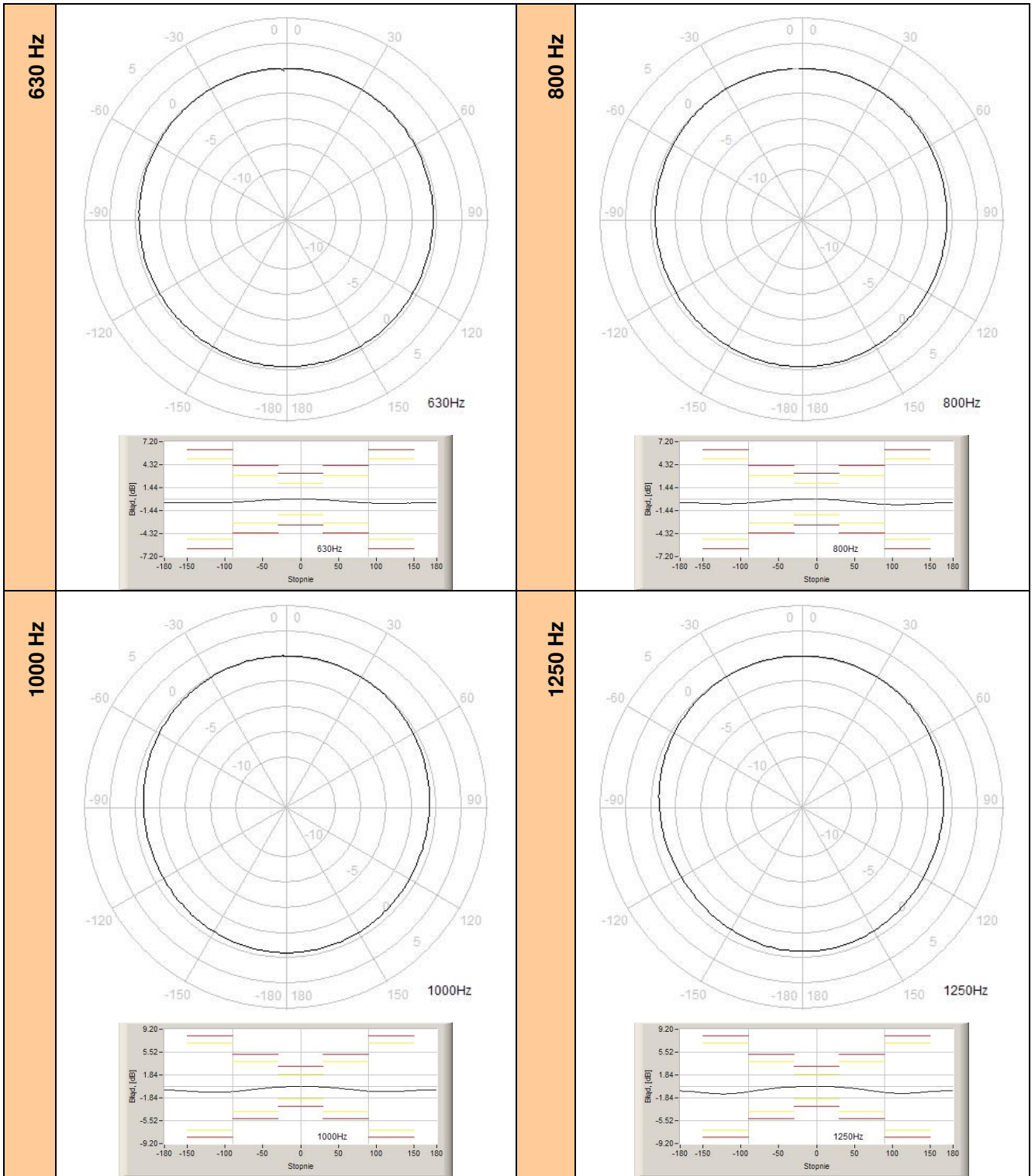
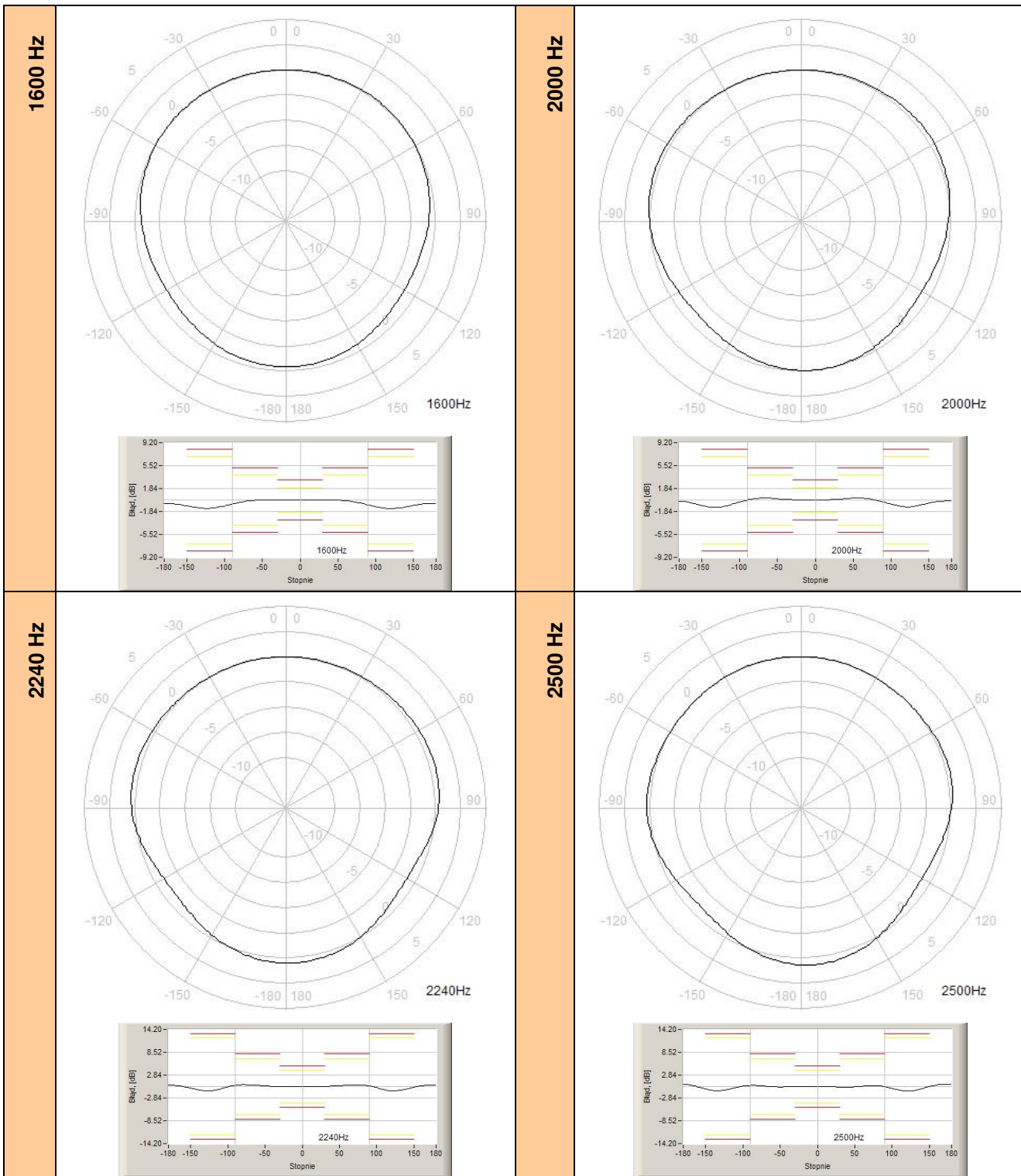


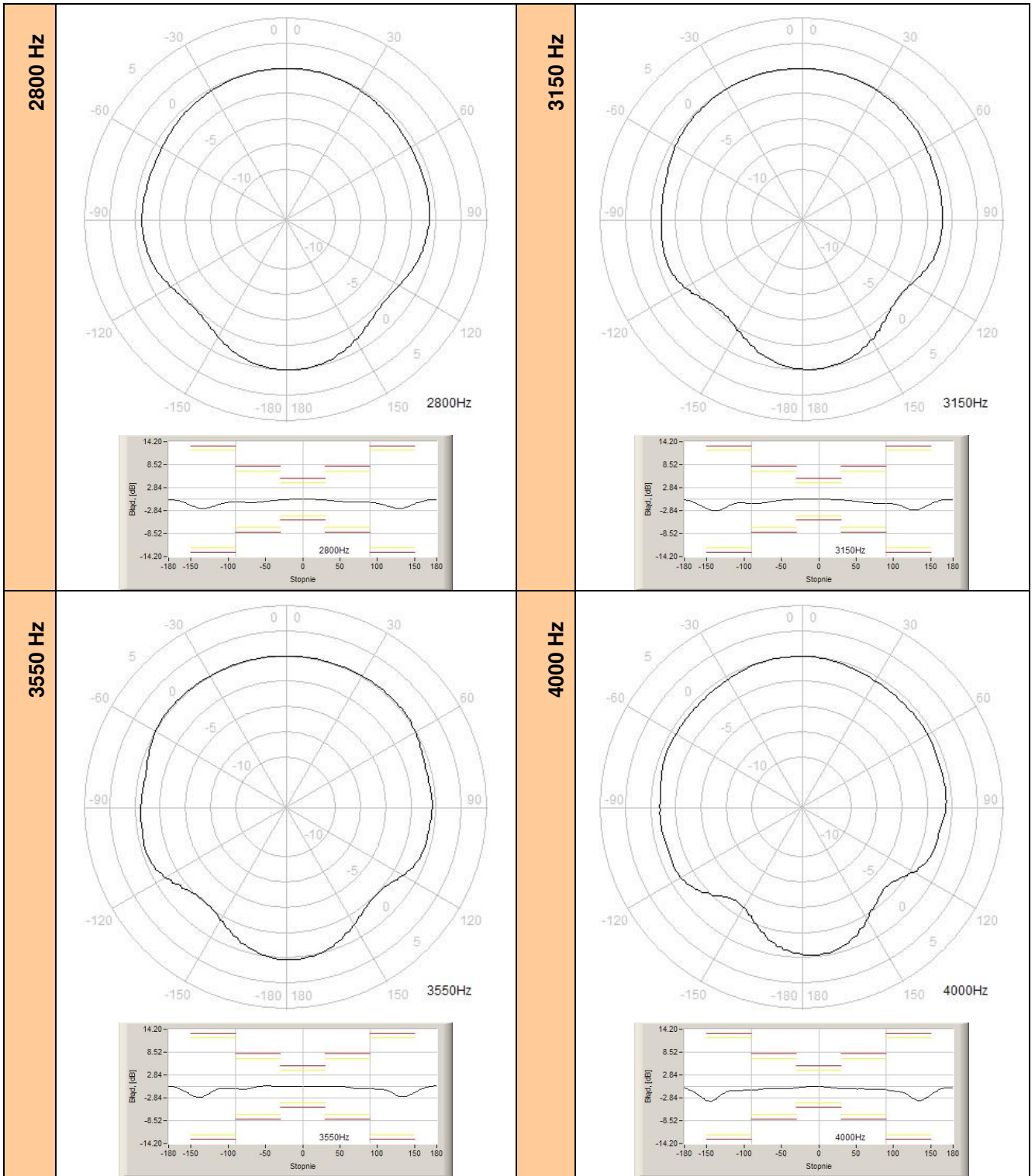
Figure C.3 Total directional characteristics (symmetrical axis)

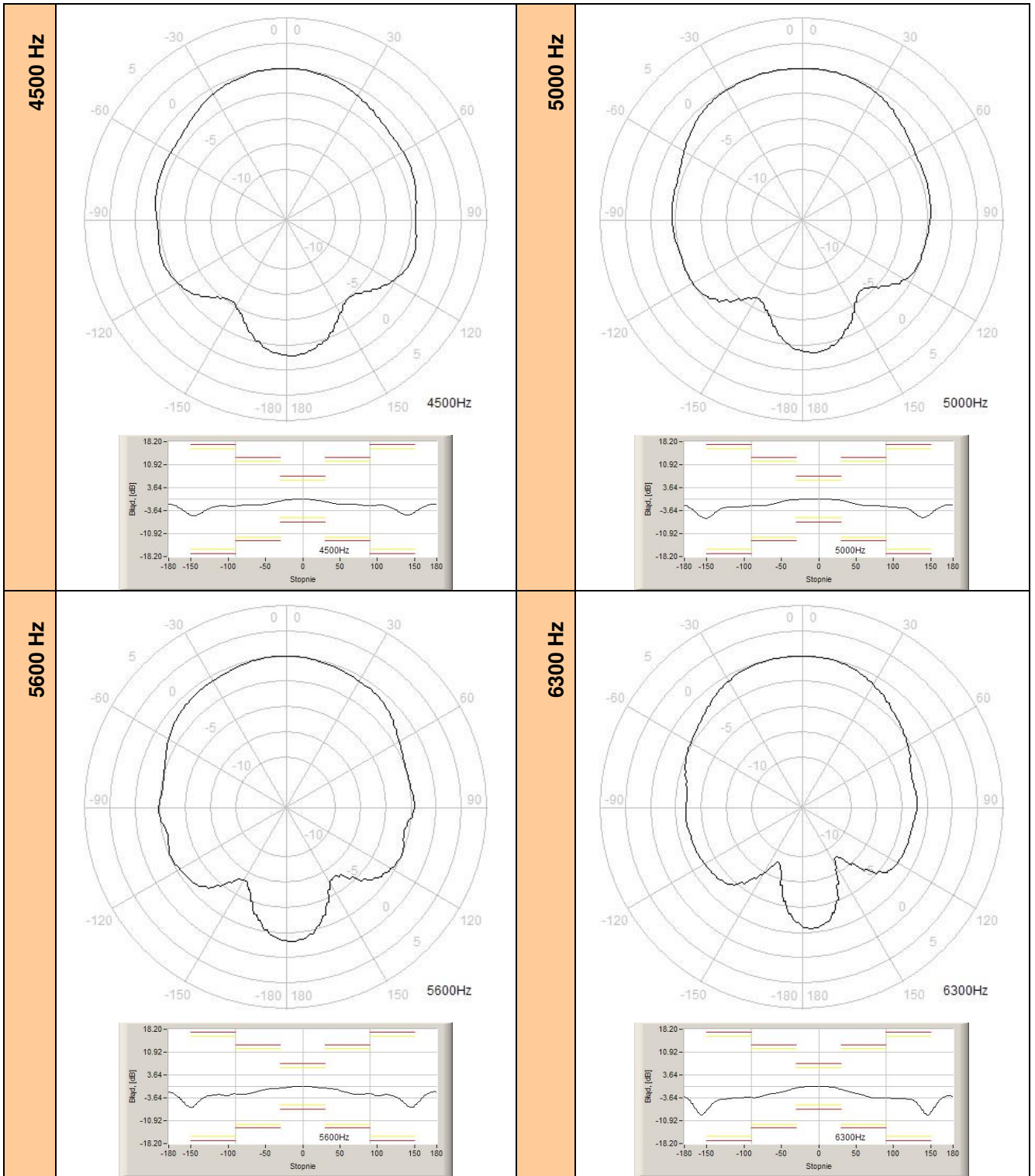
The round charts show the directional characteristic, and the charts below shows the errors for particular angles (note: limits are for class 1).

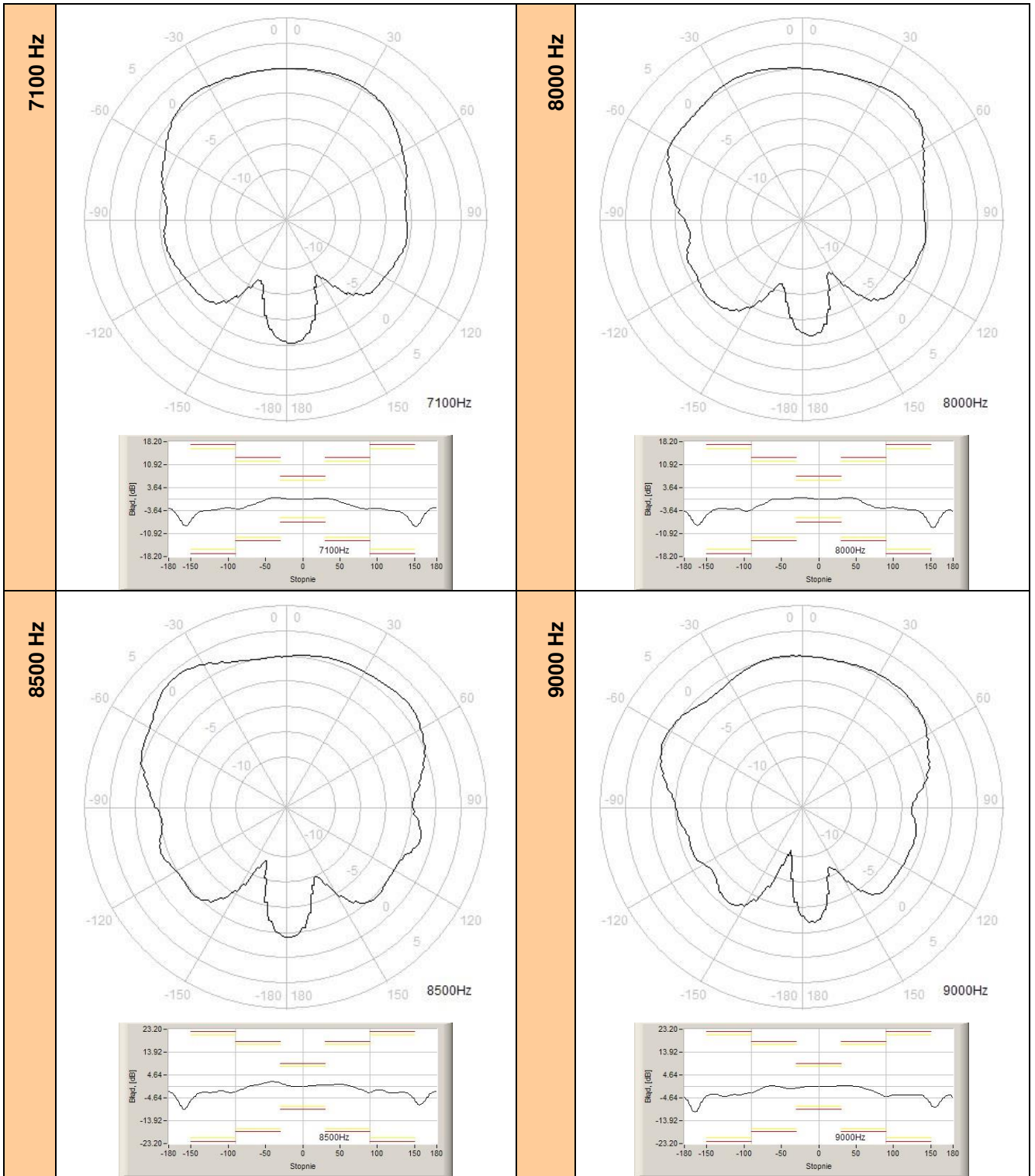












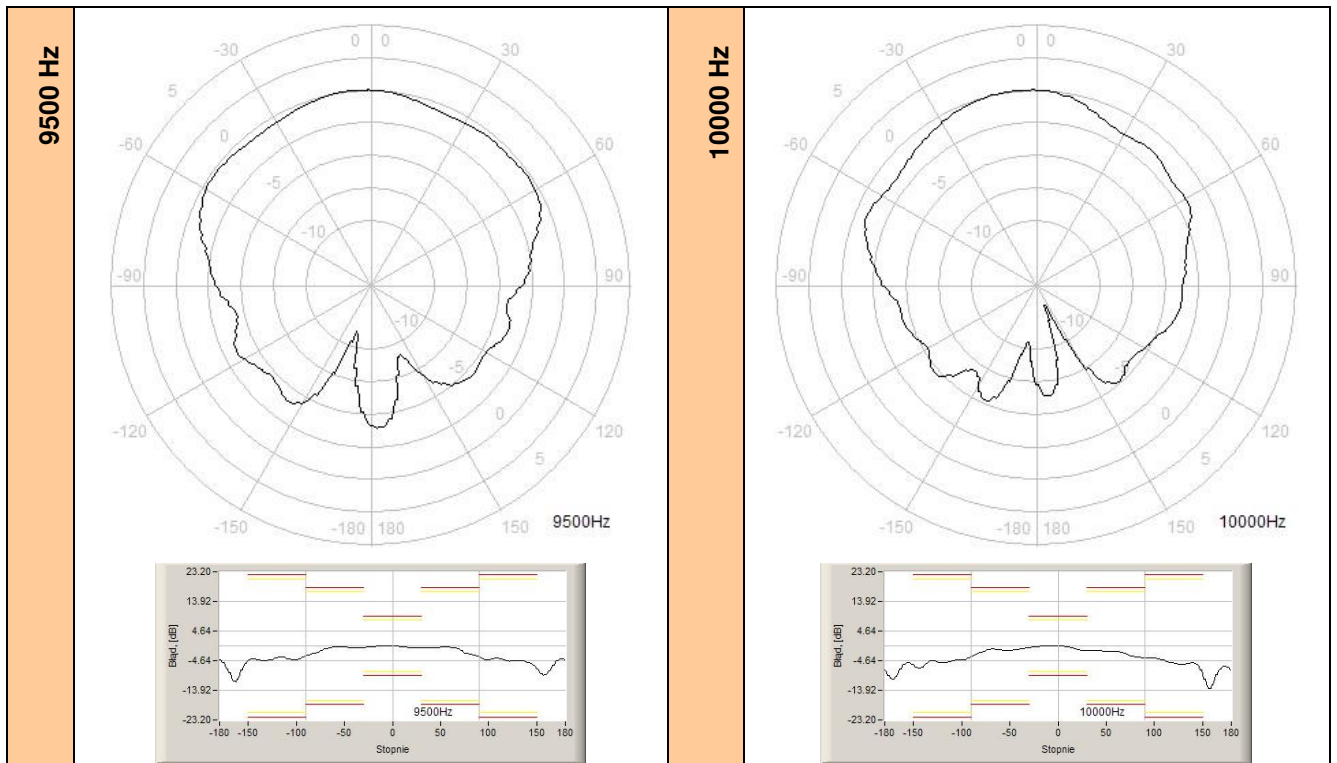


Table C.5 Directional response for SV 104BIS with microphone ST 104B and SA 122BIS windscreen (symmetrical axis)

Angle [°]										
f [Hz]	0-10	10-20	20-30	30-40	40-50	50-60	60-70	70-80	80-90	
250	-0.0	-0.0	-0.1	-0.1	-0.1	-0.1	-0.1	-0.1	-0.1	-0.2
315	-0.0	-0.0	-0.1	-0.1	-0.1	-0.2	-0.2	-0.3	-0.3	-0.3
400	-0.0	-0.0	-0.1	-0.1	-0.1	-0.1	-0.1	-0.1	-0.1	-0.1
500	0.0	-0.0	-0.1	-0.1	-0.2	-0.2	-0.3	-0.3	-0.3	-0.3
630	-0.0	-0.1	-0.1	-0.2	-0.2	-0.3	-0.4	-0.4	-0.4	-0.5
800	-0.0	-0.1	-0.1	-0.2	-0.3	-0.4	-0.5	-0.6	-0.6	-0.6
1000	0.0	-0.0	-0.1	-0.2	-0.3	-0.4	-0.5	-0.7	-0.7	-0.8
1250	-0.0	-0.0	-0.1	-0.2	-0.3	-0.5	-0.7	-0.8	-0.8	-1.0
1600	-0.0	0.0	0.0	0.0	-0.0	-0.1	-0.3	-0.5	-0.5	-0.8
2000	0.0	0.1	0.1	0.2	0.3	0.3	0.3	0.2	0.2	-0.3
2240	0.0	0.0	0.0	0.1	0.2	0.3	0.4	0.4	0.4	0.4
2500	-0.0	-0.1	-0.1	-0.1	-0.1	-0.1	0.2	0.2	0.2	0.2
2800	-0.0	-0.1	-0.2	-0.4	-0.6	-0.7	-0.8	-0.8	-0.8	-0.8
3150	-0.0	-0.1	-0.2	-0.3	-0.5	-0.7	-1.0	-1.0	-1.0	-1.1
3550	0.0	0.0	0.0	0.1	0.1	-0.1	-0.5	-0.6	-0.6	-0.6
4000	-0.1	-0.3	-0.5	-0.6	-0.6	-0.6	-0.7	-0.8	-0.8	-0.7
4500	-0.1	-0.4	-0.8	-1.3	-1.6	-1.6	-1.6	-1.9	-1.9	-2.1
5000	-0.0	-0.2	-0.4	-0.9	-1.6	-2.0	-2.1	-2.1	-2.1	-2.3
5600	-0.1	-0.3	-0.5	-0.7	-1.3	-1.9	-2.5	-2.5	-2.5	-2.5
6300	-0.1	-0.3	-0.8	-1.6	-2.3	-2.8	-3.6	-3.7	-3.7	-3.7
7100	0.1	0.2	0.2	0.2	-0.9	-1.5	-2.2	-3.0	-3.0	-3.1
8000	-0.1	-0.1	0.2	0.5	0.5	-1.1	-2.2	-2.8	-2.8	-2.9
8500	0.2	0.5	0.5	0.7	0.9	0.9	0.4	-1.5	-1.5	-2.4

9000	-0.1	-0.1	0.2	0.2	0.2	-0.6	-1.6	-2.9	-4.1
9500	-0.3	-0.6	-0.7	-0.6	-0.5	-0.4	-1.2	-2.6	-3.2
10000	-0.3	-1.1	-1.6	-1.6	-1.8	-1.9	-2.4	-3.4	-3.8
Angle [°]									
f [Hz]	90-100	100-110	110-120	120-130	130-140	140-150	150-160	160-170	170-180
250	-0.2	-0.2	-0.2	-0.3	-0.3	-0.3	-0.3	-0.3	-0.3
315	-0.3	-0.4	-0.4	-0.4	-0.4	-0.4	-0.4	-0.4	-0.4
400	-0.1	-0.1	-0.1	-0.0	0.0	0.0	0.1	0.1	0.1
500	-0.4	-0.4	-0.4	-0.4	-0.4	-0.4	-0.4	-0.4	-0.4
630	-0.5	-0.5	-0.5	-0.5	-0.5	-0.5	-0.5	-0.5	-0.5
800	-0.7	-0.7	-0.7	-0.7	-0.6	-0.6	-0.5	-0.5	-0.4
1000	-0.8	-0.9	-0.9	-0.8	-0.8	-0.7	-0.7	-0.6	-0.6
1250	-1.1	-1.1	-1.1	-1.1	-1.0	-1.0	-0.8	-0.8	-0.7
1600	-1.1	-1.3	-1.4	-1.4	-1.3	-1.1	-0.9	-0.7	-0.6
2000	-0.7	-0.9	-1.1	-1.1	-1.0	-0.7	-0.5	-0.3	-0.2
2240	-0.2	-0.8	-1.0	-1.1	-0.9	-0.6	0.2	0.4	0.4
2500	-0.5	-0.9	-1.1	-1.1	-0.9	-0.5	0.4	0.6	0.6
2800	-1.0	-1.5	-1.9	-2.3	-2.3	-1.9	-1.3	-0.5	-0.2
3150	-1.2	-1.7	-2.3	-2.7	-2.7	-2.0	-1.3	-0.4	-0.2
3550	-0.7	-0.8	-1.4	-2.5	-2.6	-2.3	-1.6	-0.5	0.1
4000	-1.2	-1.3	-2.0	-3.4	-3.5	-3.2	-2.2	-0.8	-0.3
4500	-2.1	-2.0	-2.7	-4.0	-5.0	-5.1	-4.3	-2.4	-1.7
5000	-2.5	-2.6	-3.0	-4.8	-5.9	-5.9	-4.5	-2.7	-1.9
5600	-3.0	-3.0	-2.9	-3.8	-6.0	-6.7	-6.2	-3.7	-2.0
6300	-3.9	-4.0	-4.0	-5.1	-7.5	-9.0	-8.0	-4.6	-3.2
7100	-3.0	-3.2	-3.7	-3.9	-5.5	-8.2	-8.7	-6.1	-3.2
8000	-2,9	-3,0	-3,3	-3,5	-4,5	-8,2	-9,2	-6,6	-3,8
8500	-2,4	-1,7	-2,6	-2,6	-2,7	-4,7	-7,5	-6,8	-3,0
9000	-4,2	-3,5	-3,5	-3,5	-3,8	-6,4	-8,5	-6,9	-4,3
9500	-4,5	-4,4	-4,8	-4,8	-5,1	-6,7	-9,2	-8,6	-4,7
10000	-3,9	-4,5	-5,3	-5,8	-5,7	-7,5	-13,4	-12,2	-7,5
Angle [°]									
f [Hz]	180-190	190-200	200-210	210-220	220-230	230-240	240-250	250-260	260-270
250	-0.3	-0.3	-0.3	-0.3	-0.3	-0.2	-0.2	-0.2	-0.2
315	-0.4	-0.4	-0.4	-0.3	-0.3	-0.3	-0.3	-0.2	-0.2
400	0.1	0.1	0.1	0.1	0.1	0.1	0.1	0.0	0.0
500	-0.4	-0.4	-0.4	-0.4	-0.4	-0.4	-0.3	-0.3	-0.3
630	-0.5	-0.5	-0.5	-0.5	-0.5	-0.5	-0.5	-0.5	-0.5
800	-0.5	-0.5	-0.5	-0.5	-0.6	-0.6	-0.6	-0.6	-0.5
1000	-0.6	-0.7	-0.7	-0.8	-0.9	-1.0	-1.0	-1.0	-0.9
1250	-0.8	-0.9	-1.0	-1.1	-1.2	-1.2	-1.2	-1.1	-1.0
1600	-0.6	-0.7	-0.9	-1.2	-1.3	-1.4	-1.4	-1.2	-0.9
2000	-0.3	-0.6	-0.8	-1.1	-1.2	-1.2	-1.0	-0.6	-0.3
2240	0.4	0.3	-0.4	-0.8	-1.1	-1.1	-1.0	-0.6	0.3
2500	0.5	0.3	-0.5	-1.0	-1.1	-1.0	-0.7	-0.2	0.2
2800	-0.4	-0.8	-1.5	-2.2	-2.4	-2.3	-1.7	-1.1	-0.8
3150	-0.5	-1.3	-2.3	-2.9	-2.9	-2.5	-1.5	-1.0	-1.0
3550	-0.2	-1.0	-2.1	-2.7	-2.7	-2.2	-1.0	-0.5	-0.6
4000	-1.0	-2.2	-3.5	-3.7	-3.1	-2.0	-1.1	-1.1	-1.0
4500	-2.2	-3.6	-4.9	-5.3	-4.8	-3.3	-2.5	-2.2	-2.2
5000	-3.3	-4.9	-6.1	-6.1	-4.2	-3.0	-2.5	-2.5	-2.3
5600	-2.7	-5.1	-6.7	-6.7	-4.8	-3.2	-2.8	-3.0	-2.9
6300	-5.6	-8.4	-9.1	-7.2	-4.7	-4.1	-3.9	-3.7	-3.5

7100	-4.6	-8.2	-8.5	-6.7	-4.1	-3.6	-3.5	-3.0	-3.0
8000	-6.7	-8.4	-8.0	-4.8	-3.4	-3.1	-3.3	-3.7	-3.9
8500	-4.4	-9.3	-9.3	-5.3	-2.7	-2.5	-2.4	-2.4	-2.6
9000	-9.1	-10.6	-7.7	-3.7	-3.9	-4.2	-3.8	-3.4	-3.1
9500	-8.6	-11.3	-9.1	-4.4	-4.7	-4.5	-4.0	-4.5	-4.3
10000	-10.6	-9.6	-5.8	-7.0	-6.0	-5.4	-5.4	-4.5	-4.4
Angle [°]									
f [Hz]	270-280	280-290	290-300	300-310	310-320	320-330	330-340	340-350	350-360
250	-0.2	-0.2	-0.1	-0.1	-0.1	-0.0	-0.0	-0.0	-0.0
315	-0.2	-0.1	-0.1	-0.1	-0.0	-0.0	0.0	0.0	0.0
400	0.0	0.0	0.0	0.0	0.0	0.2	0.0	0.0	0.0
500	-0.2	-0.2	-0.1	-0.1	-0.1	-0.0	-0.0	0.0	-0.6
630	-0.4	-0.4	-0.3	-0.2	-0.2	-0.1	-0.1	-0.0	-0.3
800	-0.5	-0.4	-0.3	-0.2	-0.1	-0.1	-0.0	0.0	-0.4
1000	-0.8	-0.7	-0.6	-0.5	-0.3	-0.2	-0.1	-0.1	-0.0
1250	-0.9	-0.7	-0.5	-0.4	-0.2	-0.1	-0.1	-0.0	-0.0
1600	-0.7	-0.4	-0.2	-0.0	0.0	0.0	0.0	-0.0	-0.0
2000	0.2	0.3	0.3	0.3	0.2	0.1	0.0	0.0	0.0
2240	0.5	0.5	0.4	0.3	0.1	0.0	0.0	-0.0	0.0
2500	0.3	0.2	-0.1	-0.1	-0.1	-0.1	-0.0	-0.0	0.0
2800	-0.8	-0.9	-0.9	-0.8	-0.5	-0.4	-0.2	-0.1	-0.0
3150	-1.1	-1.0	-0.8	-0.5	-0.2	-0.1	-0.0	-0.0	-0.0
3550	-0.7	-0.7	-0.4	0.1	0.1	0.1	0.0	0.0	0.0
4000	-0.9	-0.8	-0.6	-0.6	-0.6	-0.5	-0.3	-0.1	-0.1
4500	-2.2	-1.9	-1.8	-1.8	-1.5	-1.1	-0.6	-0.2	-0.0
5000	-2.1	-2.1	-2.0	-1.5	-0.8	-0.3	-0.1	-0.1	0.0
5600	-2.6	-2.6	-2.2	-1.6	-0.9	-0.7	-0.5	-0.3	-0.1
6300	-3.6	-3.3	-2.7	-2.2	-1.8	-1.1	-0.5	-0.1	-0.0
7100	-3.1	-2.7	-1.8	-1.2	0.4	0.5	0.3	0.1	-0.0
8000	-3.4	-1.9	-1.1	-0.1	-0.1	0.4	0.4	0.4	0.2
8500	-1.9	-0.8	0.6	1.6	2.0	2.0	1.2	0.3	-0.2
9000	-2.5	-1.2	0.2	-0.4	-0.9	-0.9	-0.6	-0.1	-0.1
9500	-3.0	-2.0	-1.0	-0.4	-0.5	-0.6	-0.5	-0.2	-0.0
10000	-3.1	-1.9	-1.3	-1.5	-1.4	-1.0	-0.5	-0.1	0.0

Directional response for dosimeter Class SV 104BIS with microphone **ST 104B** and **SA 122BIS** windscreen (for orthogonal asymmetrical axis) for specified frequencies (Table C.6):

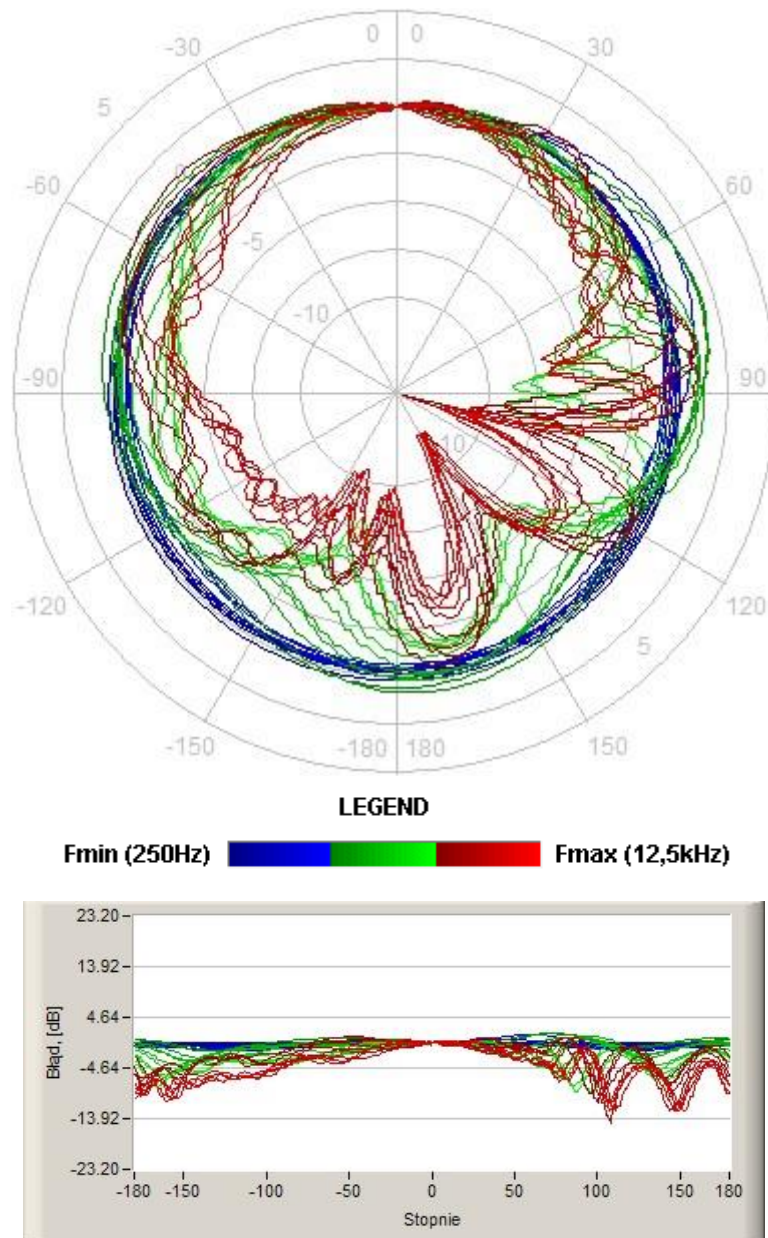
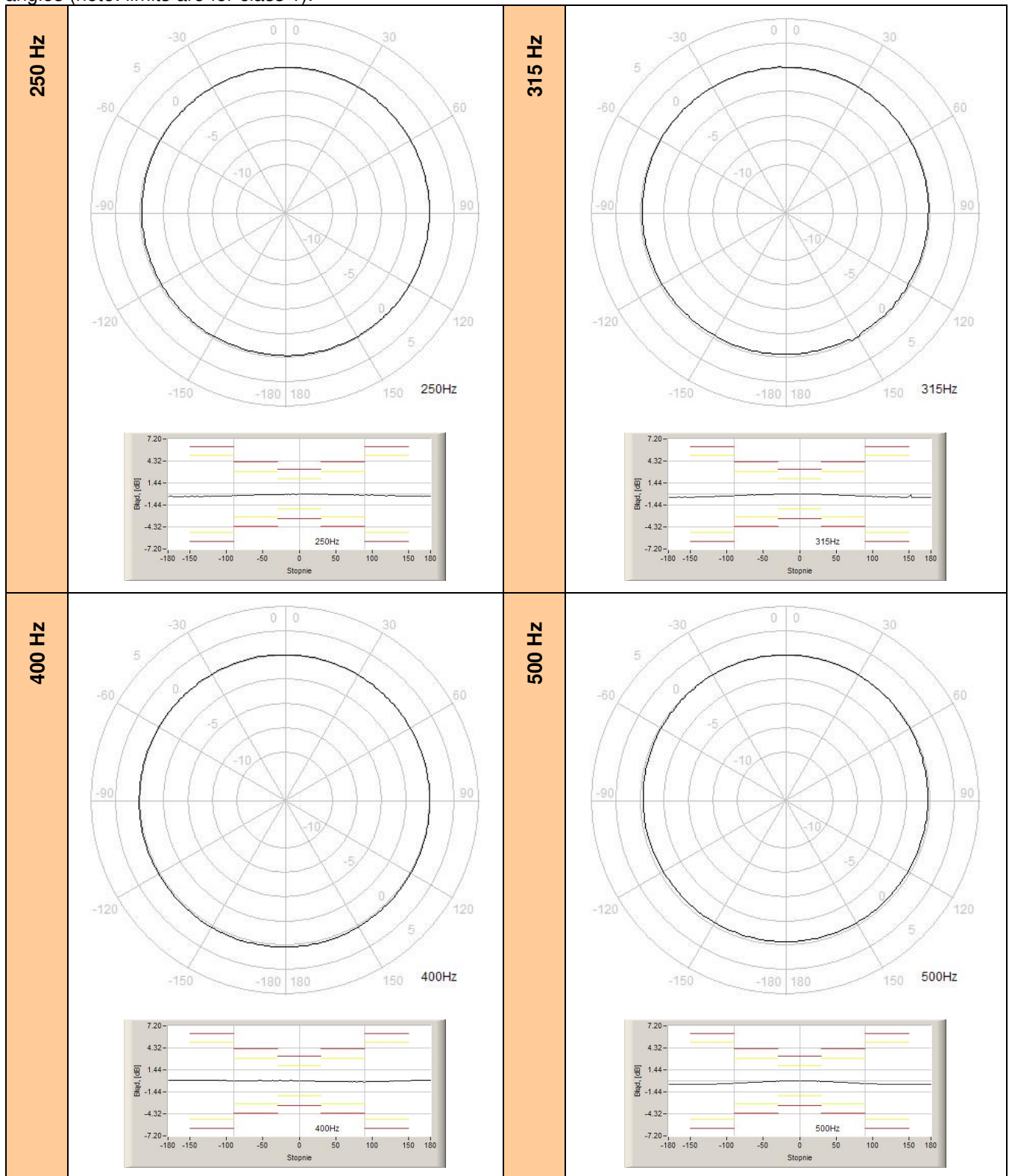
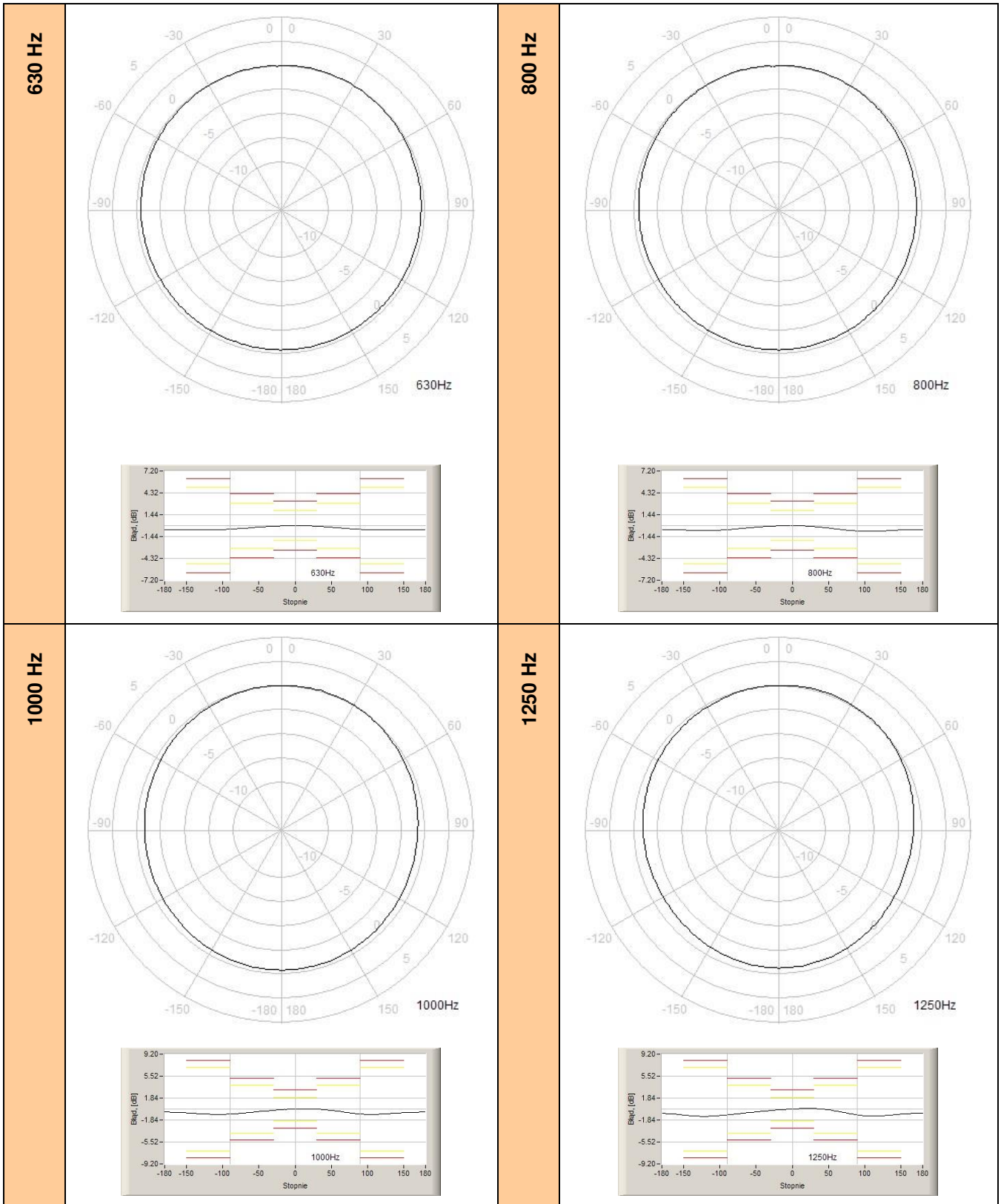


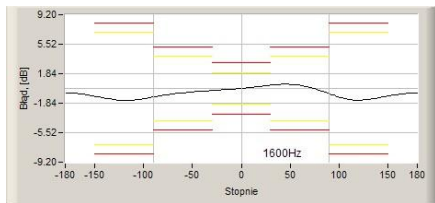
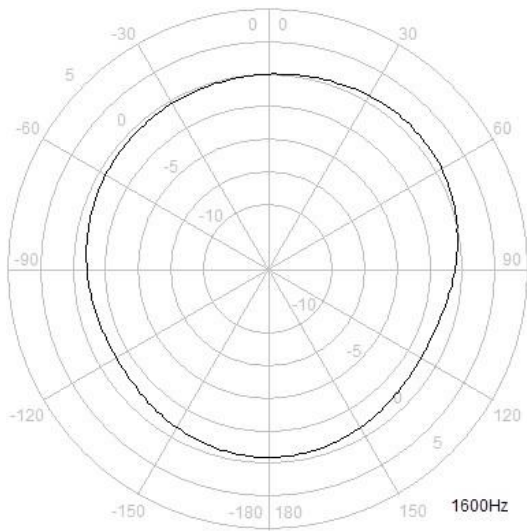
Figure C.4 Total directional characteristics (asymmetrical axis)

The round charts show the directional characteristic, and the charts below shows the errors for particular angles (note: limits are for class 1).

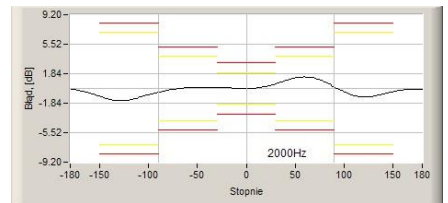
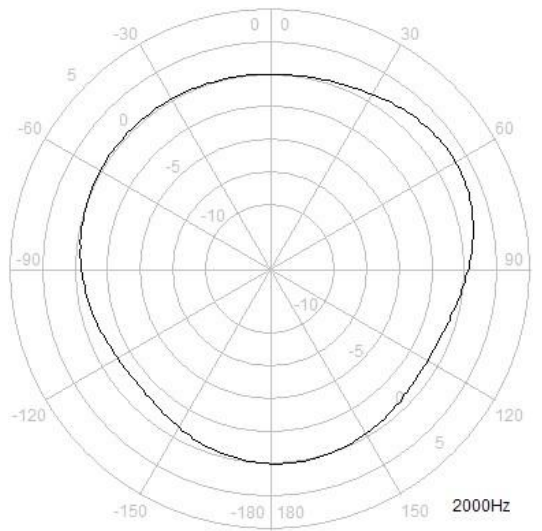




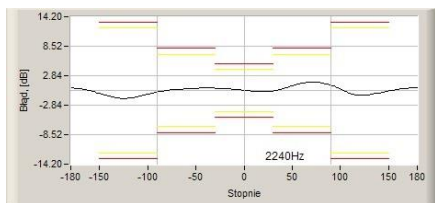
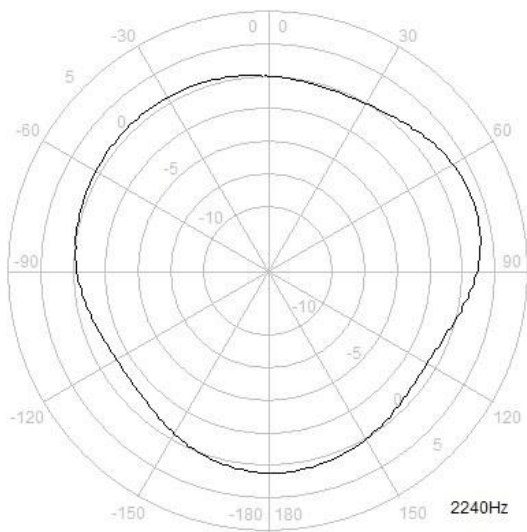
1600 Hz



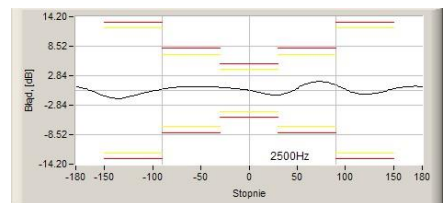
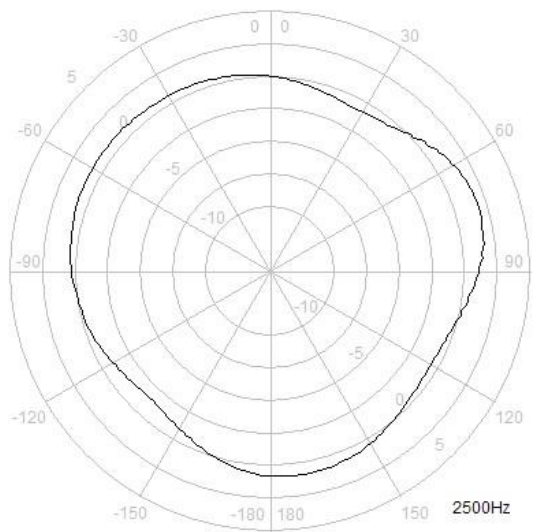
2000 Hz



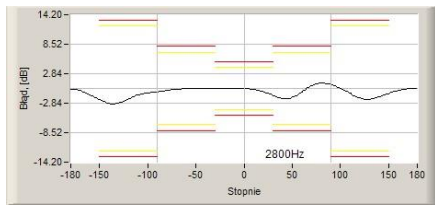
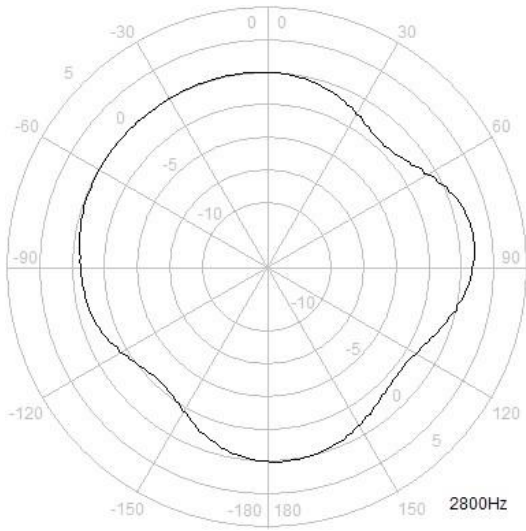
2240 Hz



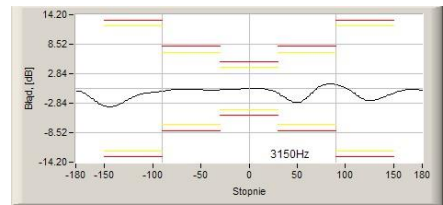
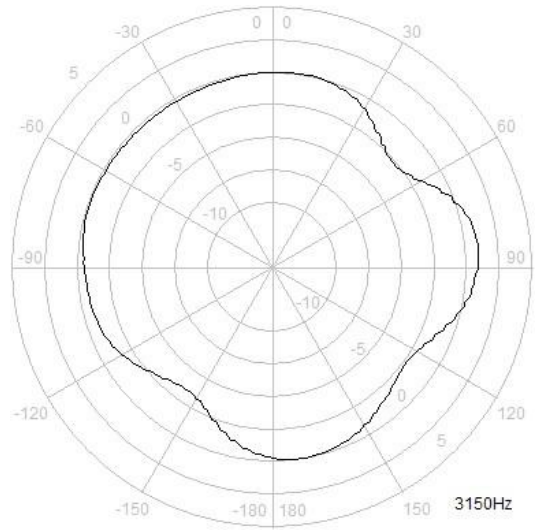
2500 Hz



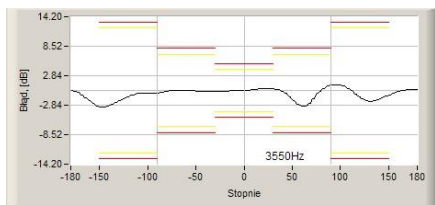
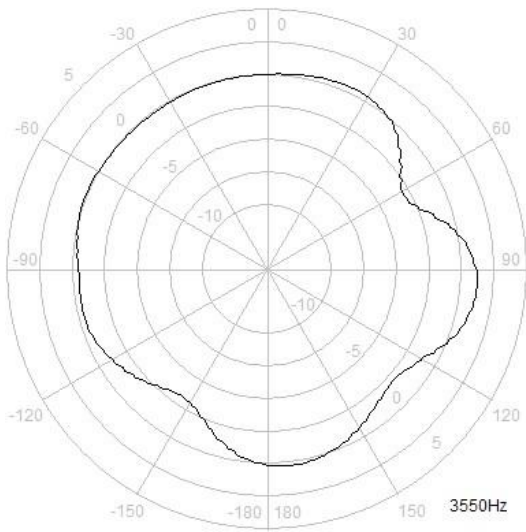
2800 Hz



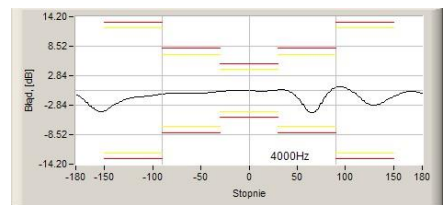
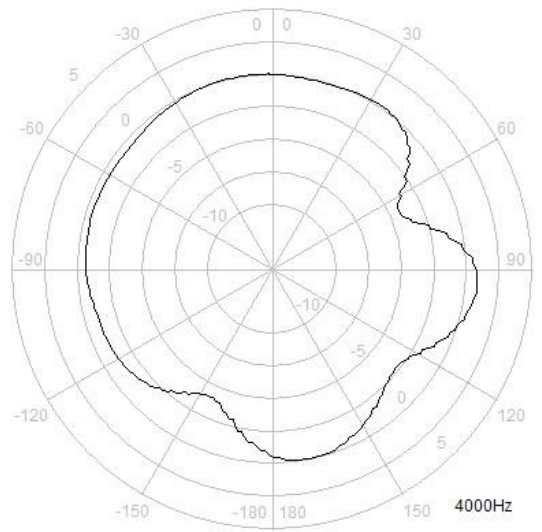
3150 Hz



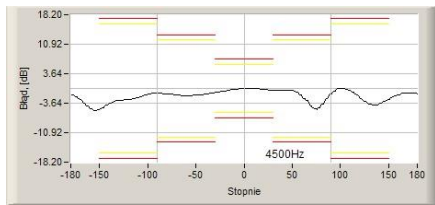
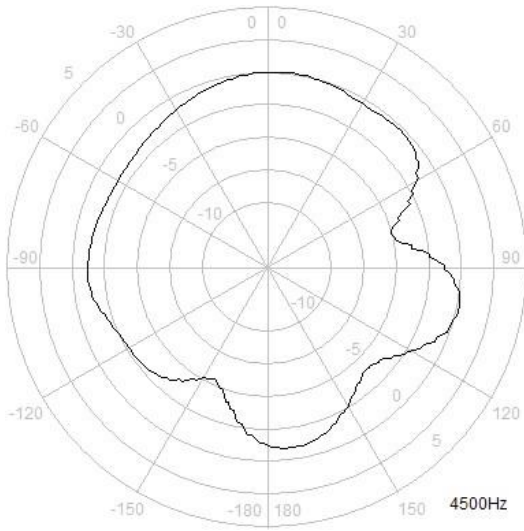
3550 Hz



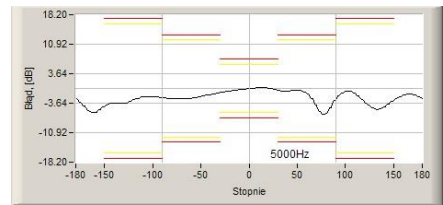
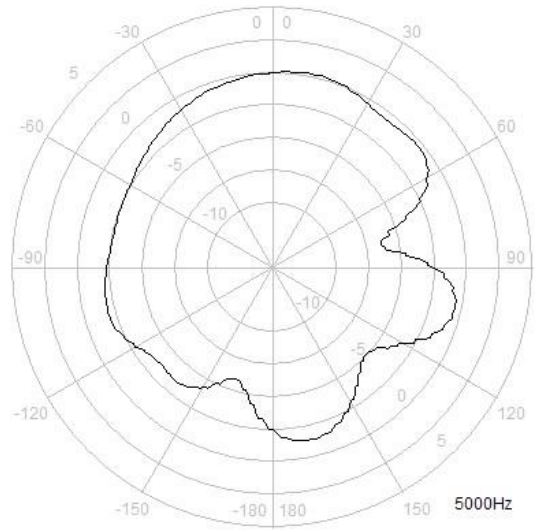
4000 Hz



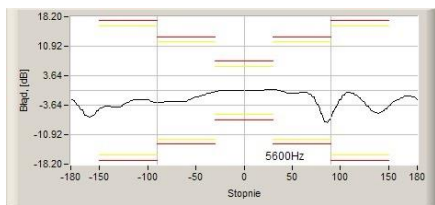
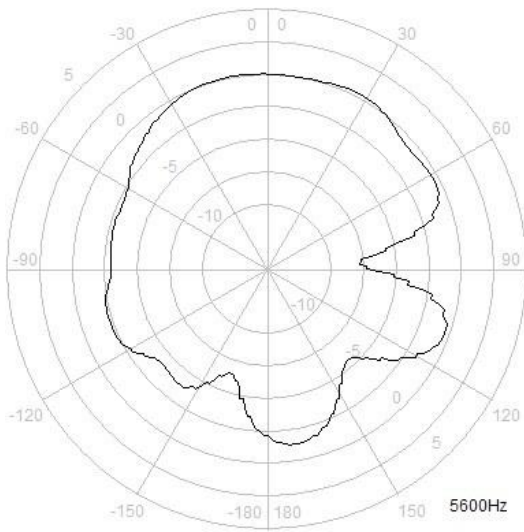
4500 Hz



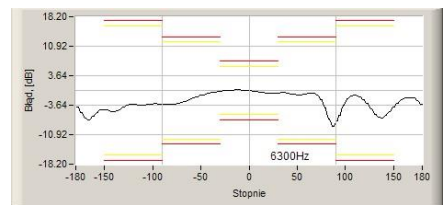
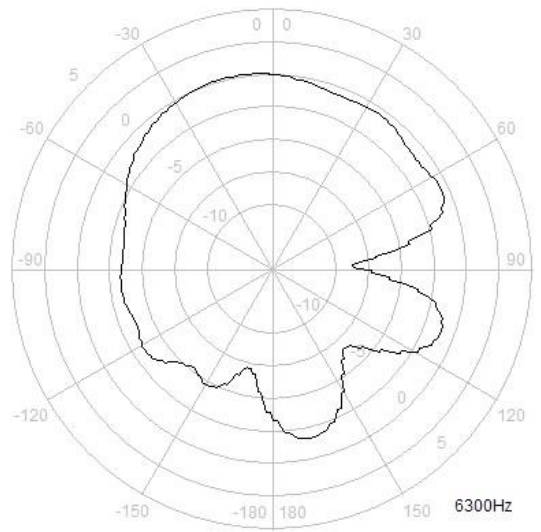
5000 Hz

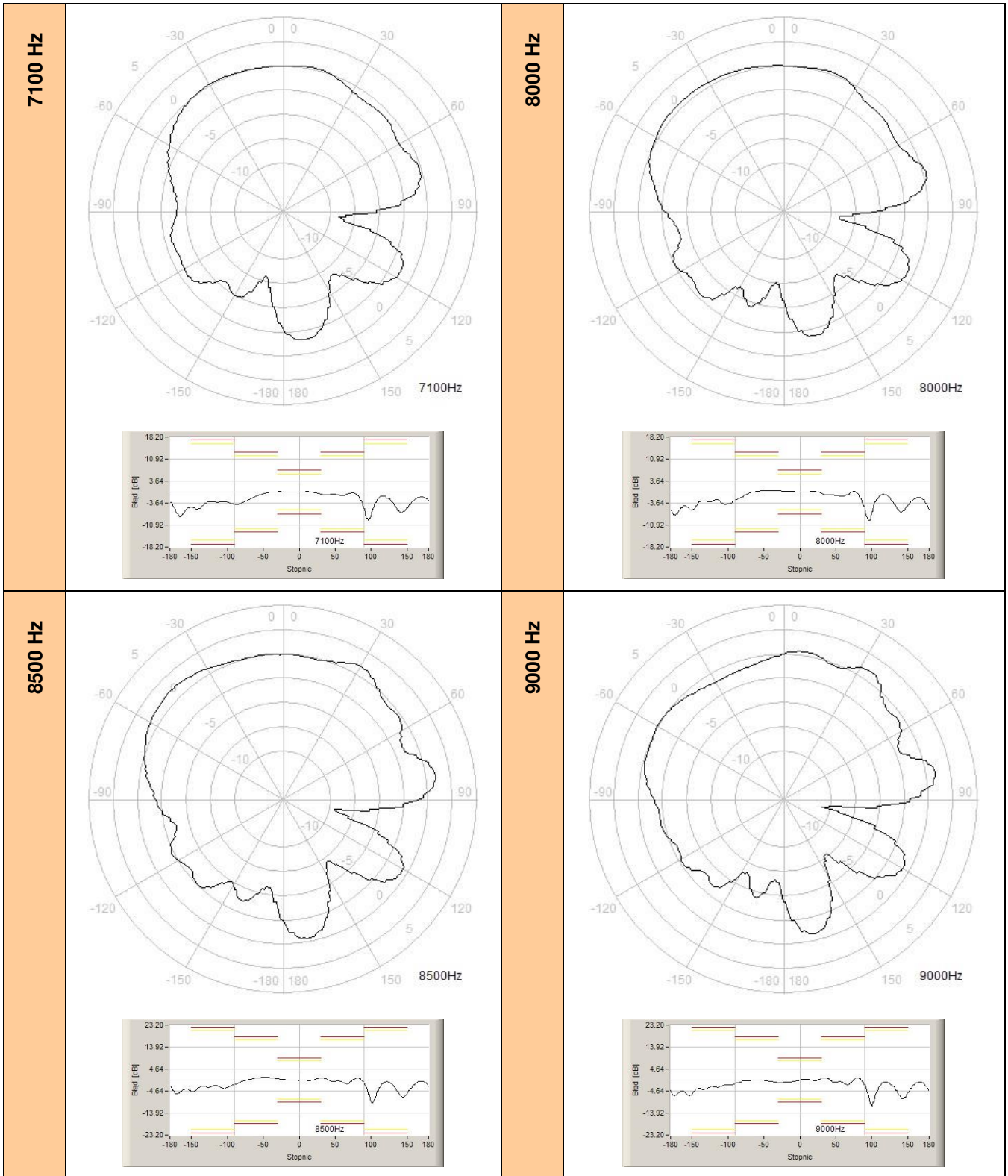


5600 Hz



6300 Hz





1000	-0.1	-0.1	-0.1	-0.0	-0.0	0.0	0.1	0.1	0.1
1250	-0.4	-0.4	-0.4	-0.4	-0.4	-0.5	-0.5	-0.5	-0.5
1600	-0.5	-0.6	-0.6	-0.6	-0.6	-0.5	-0.5	-0.5	-0.5
2000	-0.7	-0.7	-0.7	-0.7	-0.7	-0.6	-0.6	-0.5	-0.5
2240	-0.9	-0.9	-0.9	-0.8	-0.8	-0.7	-0.6	-0.5	-0.5
2500	-1.1	-1.2	-1.2	-1.1	-1.1	-0.9	-0.9	-0.8	-0.7
2800	-1.1	-1.4	-1.4	-1.4	-1.4	-1.1	-0.9	-0.7	-0.6
3150	-0.5	-0.9	-1.1	-1.1	-1.0	-0.7	-0.4	-0.2	-0.1
3550	0.9	-0.6	-1.0	-1.0	-0.9	-0.5	0.2	0.4	0.4
4000	0.9	-0.6	-0.8	-0.8	-0.7	0.2	0.5	0.7	0.7
4500	0.7	-1.0	-1.7	-2.1	-2.1	-1.5	-1.0	-0.3	-0.1
5000	0.8	-0.9	-2.1	-2.3	-2.3	-1.6	-0.8	-0.3	-0.3
5600	1.1	0.9	-1.3	-2.1	-2.1	-1.6	-0.8	-0.2	0.2
6300	0.8	-0.6	-1.9	-2.9	-2.8	-2.0	-1.0	-0.4	-0.6
7100	-1.4	-0.3	-2.0	-3.8	-4.1	-3.7	-2.6	-1.5	-1.3
8000	-2.3	-1.0	-3.1	-4.8	-5.1	-4.4	-2.7	-1.6	-2.5
8500	-6.4	-1.6	-1.8	-3.9	-5.7	-5.6	-3.7	-2.2	-2.2
9000	-7.4	-2.2	-2.2	-5.3	-6.8	-6.2	-4.1	-2.1	-3.4
9500	-9.3	-5.8	-2.0	-3.5	-6.6	-6.8	-5.3	-2.6	-2.8
10000	-9.3	-6.4	-1.2	-2.9	-6.6	-6.6	-4.2	-2.2	-5.9

Angle [°]

f [Hz]	180-190	190-200	200-210	210-220	220-230	230-240	240-250	250-260	260-270
630	-0.3	-0.4	-0.3	-0.3	-0.3	-0.3	-0.3	-0.3	-0.3
800	-0.5	-0.4	-0.4	-0.4	-0.4	-0.4	-0.4	-0.3	-0.3
1000	0.1	0.1	0.1	0.1	0.1	0.1	0.1	0.1	0.0
1250	-0.5	-0.5	-0.5	-0.4	-0.4	-0.4	-0.4	-0.4	-0.3
1600	-0.5	-0.5	-0.5	-0.5	-0.6	-0.6	-0.6	-0.5	-0.5
2000	-0.5	-0.5	-0.6	-0.6	-0.6	-0.6	-0.6	-0.6	-0.6
2240	-0.5	-0.6	-0.6	-0.7	-0.8	-0.9	-0.9	-0.9	-0.9
2500	-0.8	-0.9	-1.0	-1.1	-1.2	-1.2	-1.2	-1.2	-1.1
2800	-0.6	-0.7	-1.0	-1.2	-1.4	-1.5	-1.5	-1.4	-1.2
3150	-0.2	-0.6	-1.0	-1.4	-1.5	-1.5	-1.4	-1.1	-0.8
3550	0.4	0.2	-0.6	-1.2	-1.5	-1.6	-1.5	-1.2	-0.8
4000	0.6	-0.4	-1.1	-1.6	-1.6	-1.5	-1.0	-0.6	0.2
4500	-0.4	-1.2	-2.2	-2.9	-3.0	-2.7	-1.9	-1.2	-0.8
5000	-0.9	-2.4	-3.3	-3.5	-3.3	-2.3	-1.6	-0.9	-0.7
5600	-0.6	-2.0	-3.2	-3.3	-2.9	-1.9	-1.1	-0.5	-0.5
6300	-2.0	-3.7	-4.1	-3.9	-2.7	-1.8	-1.3	-1.2	-1.0
7100	-2.8	-5.0	-5.4	-5.0	-3.5	-2.9	-2.7	-2.1	-1.3
8000	-4.3	-5.9	-5.8	-4.1	-3.6	-3.5	-2.8	-1.9	-2.2
8500	-4.3	-6.5	-6.4	-4.3	-4.2	-4.0	-2.6	-2.4	-3.0
9000	-6.8	-7.2	-5.5	-5.3	-5.2	-3.8	-3.7	-3.7	-3.4
9500	-7.0	-8.1	-6.0	-5.6	-5.5	-3.4	-3.4	-3.3	-4.1
10000	-7.7	-6.6	-6.1	-5.8	-3.3	-3.3	-3.2	-4.1	-4.0

Angle [°]

f [Hz]	270-280	280-290	290-300	300-310	310-320	320-330	330-340	340-350	350-360
630	-0.2	-0.2	-0.2	-0.1	-0.1	-0.1	-0.1	-0.1	-0.1
800	-0.2	-0.2	-0.2	-0.1	-0.1	-0.1	-0.0	-0.0	0.0
1000	0.0	0.0	0.0	0.1	0.0	0.1	0.1	0.1	0.0
1250	-0.3	-0.3	-0.2	-0.2	-0.1	-0.1	-0.0	-0.0	0.0
1600	-0.5	-0.4	-0.4	-0.3	-0.2	-0.1	-0.1	-0.0	-0.3
2000	-0.5	-0.4	-0.4	-0.3	-0.2	-0.1	-0.1	-0.0	-0.3
2240	-0.8	-0.8	-0.6	-0.5	-0.4	-0.3	-0.2	-0.1	-0.0
2500	-1.0	-0.8	-0.7	-0.6	-0.5	-0.3	-0.2	-0.1	-0.1

2800	-1.0	-0.8	-0.7	-0.5	-0.4	-0.3	-0.2	-0.1	-0.1
3150	-0.4	-0.2	0.1	0.2	0.2	0.2	0.1	0.1	-0.0
3550	-0.3	0.1	0.3	0.4	0.4	0.4	0.4	0.3	-0.5
4000	0.5	0.6	0.7	0.7	0.7	0.6	0.5	0.4	0.2
4500	-0.6	-0.4	-0.1	-0.1	-0.0	-0.0	0.0	0.0	0.0
5000	-0.5	-0.2	-0.2	-0.2	-0.3	-0.3	-0.2	-0.2	-0.1
5600	-0.5	-0.1	0.1	-0.1	-0.2	-0.2	-0.1	-0.1	-0.1
6300	-0.7	-0.6	-0.5	-0.6	-0.6	-0.4	-0.2	0.0	0.0
7100	-1.3	-1.5	-1.7	-1.7	-1.6	-1.3	-0.9	-0.5	-0.2
8000	-2.5	-2.5	-2.5	-2.3	-1.8	-1.4	-0.8	-0.5	-0.2
8500	-3.0	-2.8	-2.8	-2.5	-1.5	-0.9	-0.3	0.1	0.2
9000	-3.5	-3.4	-3.0	-1.9	-1.2	-0.5	-0.1	0.1	0.1
9500	-4.1	-3.5	-2.5	-1.4	-0.5	0.1	0.1	0.1	-0.0
10000	-2.4	-1.6	-0.2	0.4	0.4	0.4	0.3	0.2	0.1

C.2 SPECIFICATION OF THE SV 104BIS AS 1/1 AND 1/3 OCTAVE ANALYSER

The SV 104BIS instrument operating as **1/1 OCTAVE** or **1/3 OCTAVE** sound analyser meets the IEC 61260-1:2014 standard for the pass band filters.



Note: Simultaneously to the frequency analysis SV 104BIS operates as a Dosimeter!

Signal input

Connector	6 pin SVANTEK
Maximum input voltage	SV 104BIS meets the requirements of the EN/IEC 61010-1 category I measurement circuit. The input voltage shall not exceed the limits between 0 V and +3 V.
Impedance	2 x 39kΩ / 44nF.

Linear operating ranges

For the sinusoidal signal and microphone sensitivity 1 mV/Pa.

See Table C.1 on page [129](#) for details.



Note: For the signals with the crest factor $n > 1.41$ upper measuring range of the RMS (**LEQ** and **SPL**) is reduced. The valid upper limit can be calculated according to the below given formula:

$$A_n = 137 - 20 \log(n/\sqrt{2}), \text{ where } A \text{ is the upper limit for the sinusoidal signal}$$

Example: For the crest factor $n = 10$ the upper limit is $A_{10} = 120 \text{ dB}$

Measuring frequency range with the Z filter (-3 dB): 20 Hz ÷ 10.0 kHz

Maximum peak voltage of input sinusoidal signal, which can be led to the Dose Meter without destruction of the meter: 3 V Peak-Peak

RMS detector

Digital	"True RMS" with Peak detection
Resolution	0.1 dB
Range	327.7 dB
Crest Factor	unlimited (for signals in 10 kHz band)

Reference conditions as per IEC 61260-1:2014

Reference frequency	1000 Hz
Reference level	114 dB
Reference temperature	from +20°C to +26°C
Reference relative humidity	from 35% to 65%

Calibration (electrical)

Calibration level	114.0 dB (ref. $1\mu\text{V}_{\text{RMS}}$)
Basic accuracy	$< \pm 0.1$ dB (for the temperature $T = +23^{\circ}\text{C} \pm 5^{\circ}\text{C}$ for the sinusoidal signal 114 dB _{RMS} in the bandwidth 20 Hz ÷ 10 kHz with the Z input filter)

Voltage measurement error in the full temperature range

$< \pm 0.1$ dB when the temperature is from -10°C to $+40^{\circ}\text{C}$ for the sinusoidal signal.

Overload detector

The instrument has the built-in overload detectors. The overload in the measurement channel (in its analogue part) and the overload of the analogue / digital converter are both detected. The “overload” indication is when the input signal amplitude is **0.5 dB above** the declared “Peak measurement range”

Anti-aliasing filter

Built-in electric anti-aliasing filter ensuring correct sampling of the measured signal.

Pass band (-3 dB)	11.3 kHz
Stop band	14.4 kHz
Attenuation in the stop band	> 50 dB
Sampling frequency	24 kHz
Analogue to digital converter	sigma-delta 24 bit
Internal oscillator accuracy	0.01% (for $f = 1$ kHz and $T = +23^{\circ}\text{C}$)

Digital filters

Weighting filters

Z meeting requirements of the IEC 61672-1:2013 standard for the Class 2 “**Z**” filter

A meeting requirements of the IEC 651 and IEC 61672-1:2013 standard for the Class 2 “**A**” filter

C meeting requirements of the IEC 651 and IEC 61672-1:2013 standard for the Class 2 “**C**” filter

See part for the A and C filters characteristics.

Noise levels (measured with the **SC 104BT** and source impedance **50 Ω**, **Microphone** compensation switched-off)

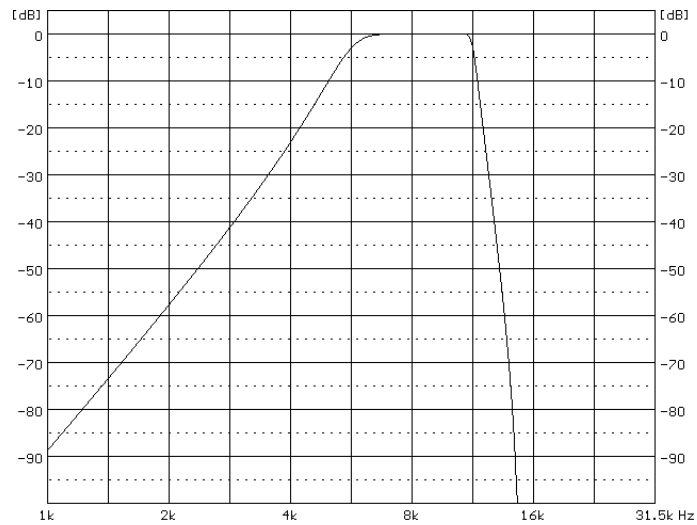
“ Z ” weighting	$< 316 \mu\text{V}_{\text{RMS}}$, (50 dB)
“ A ” weighting	$< 126 \mu\text{V}_{\text{RMS}}$, (42 dB)
“ C ” weighting	$< 112 \mu\text{V}_{\text{RMS}}$, (41 dB)

Noise levels during test according IEC 61252 p.12.5 (measured in presence of magnetic field 80A/m @ 50Hz, “the worst device orientation”, with the **SC 104BT** and source impedance **50 Ω**, **Microphone** compensation switched-off)

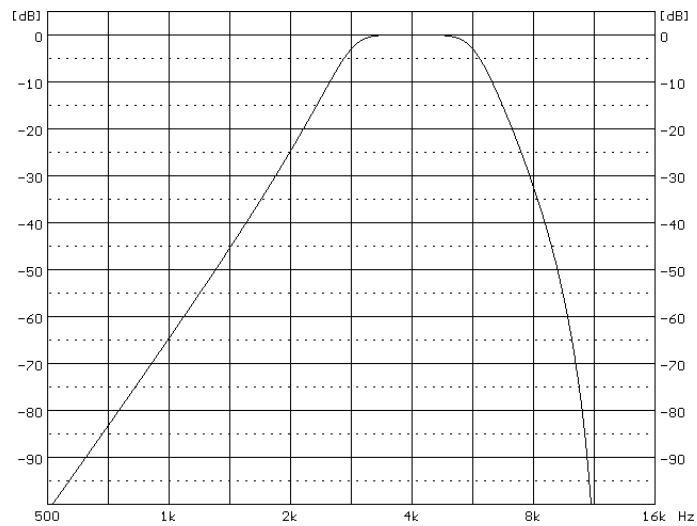
“ Z ” weighting	$< 251 \mu\text{V}_{\text{RMS}}$, (48.0 dB)
“ A ” weighting	$< 114 \mu\text{V}_{\text{RMS}}$, (41.2 dB)
“ C ” weighting	$< 104 \mu\text{V}_{\text{RMS}}$, (40.4 dB)

1/1-octave filters

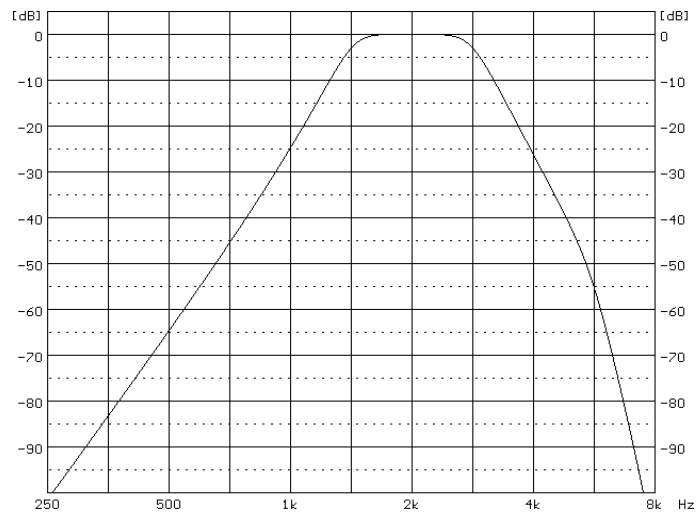
9 filters with centre frequencies from 31.5 Hz to 8 kHz (base 10), meeting IEC 61260-1:2014 for Class 1.



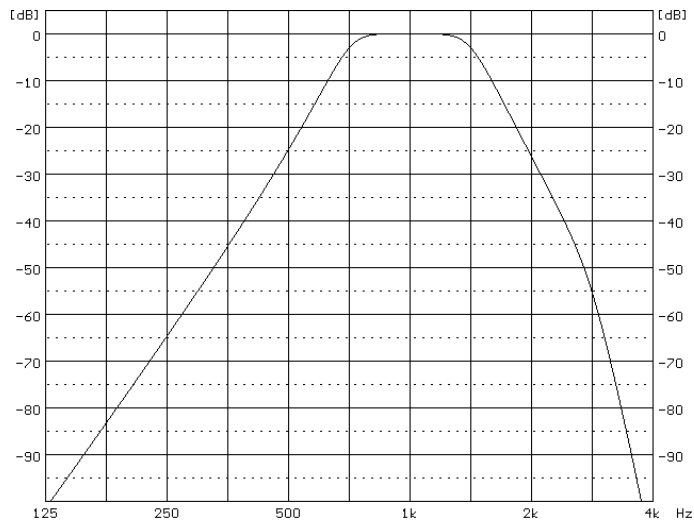
8.0 kHz 1/1 octave filter



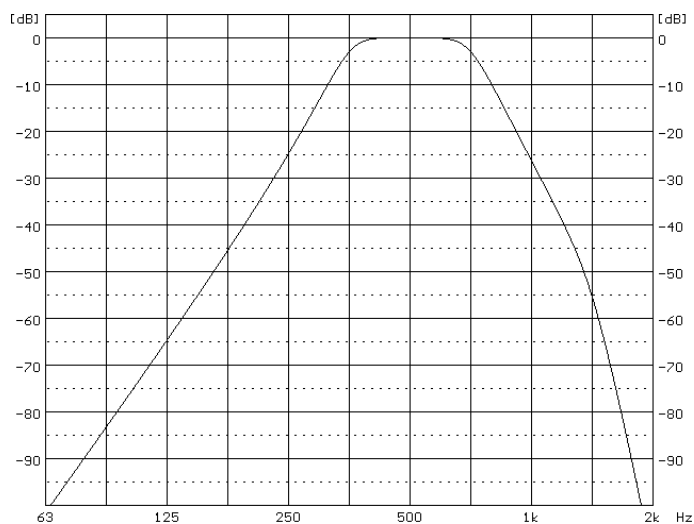
4.0 kHz 1/1 octave filter



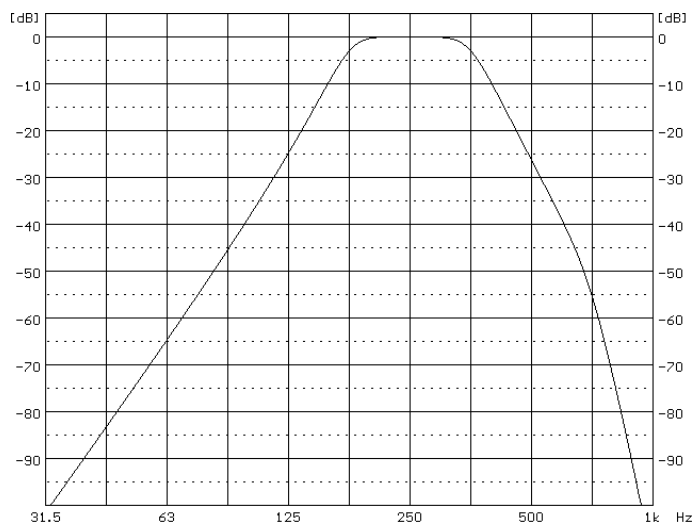
2.0 kHz 1/1 octave filter



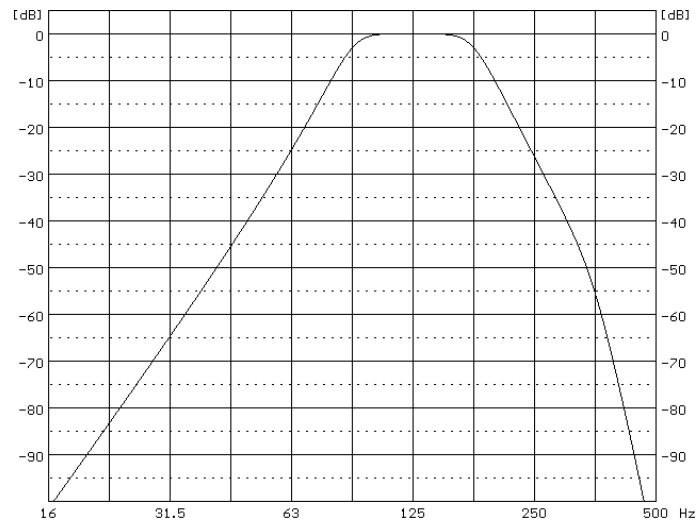
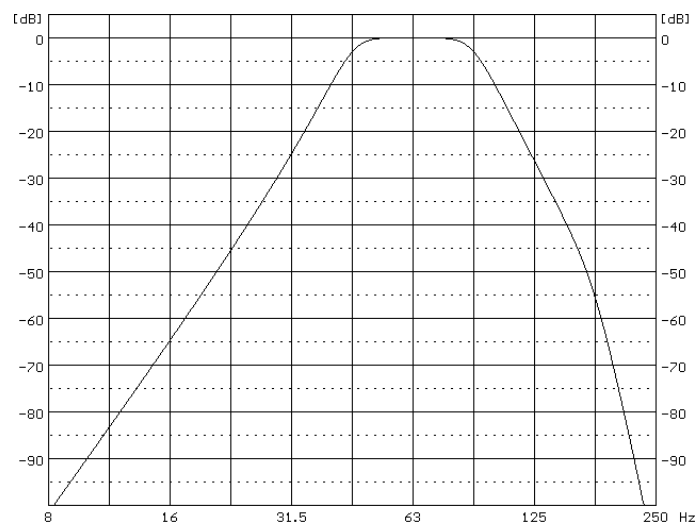
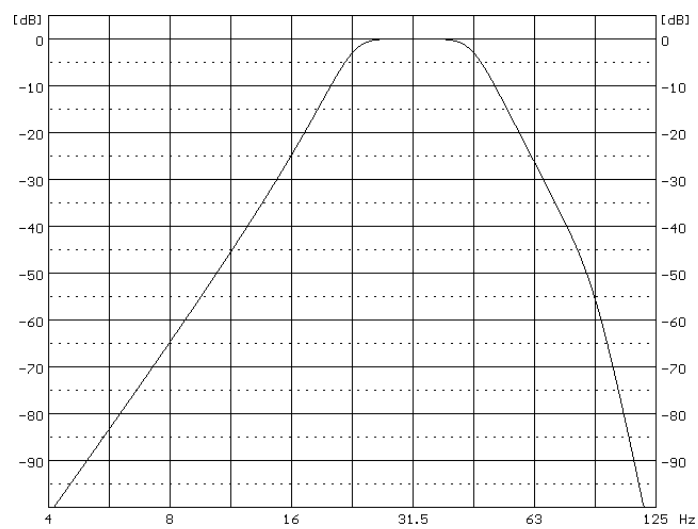
1.0 kHz 1/1 octave filter



500 Hz 1/1 octave filter

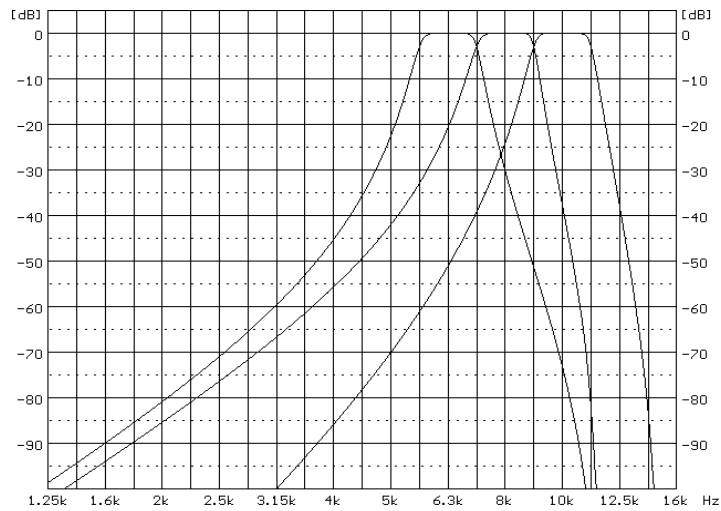


250 Hz 1/1 octave filter

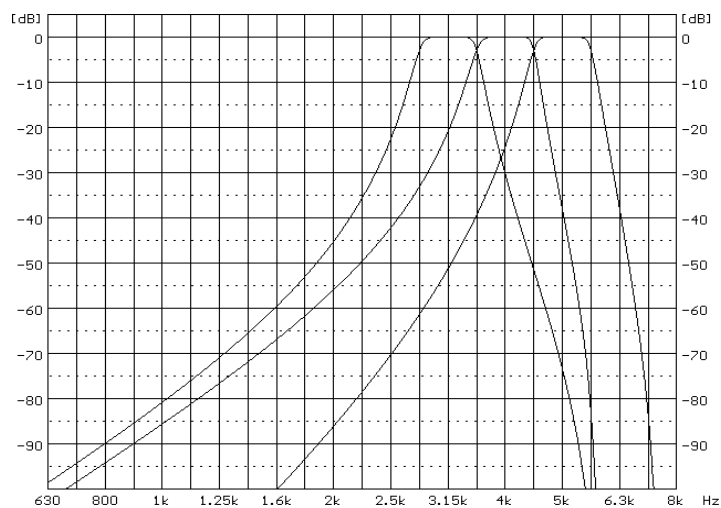
**125 Hz 1/1 octave filter****63.0 Hz 1/1 octave filter****31.5 Hz 1/1 octave filter**

1/3-octave filters

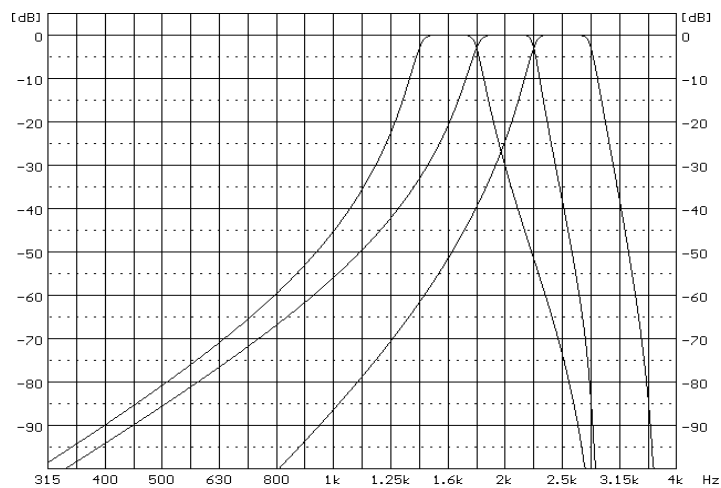
28 filters with centre frequencies from 20 Hz to 10 kHz (base 10), meeting IEC 61260-1:2014 for Class 1.



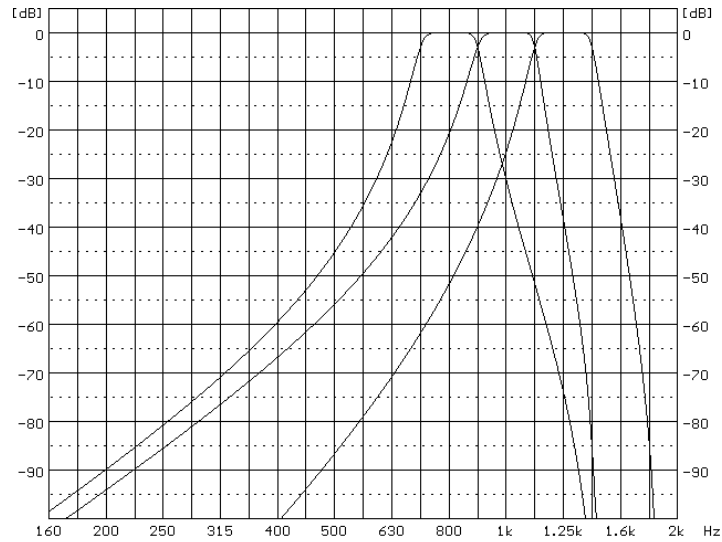
1/3 octave filters for 8.0 kHz 1/1 octave filter



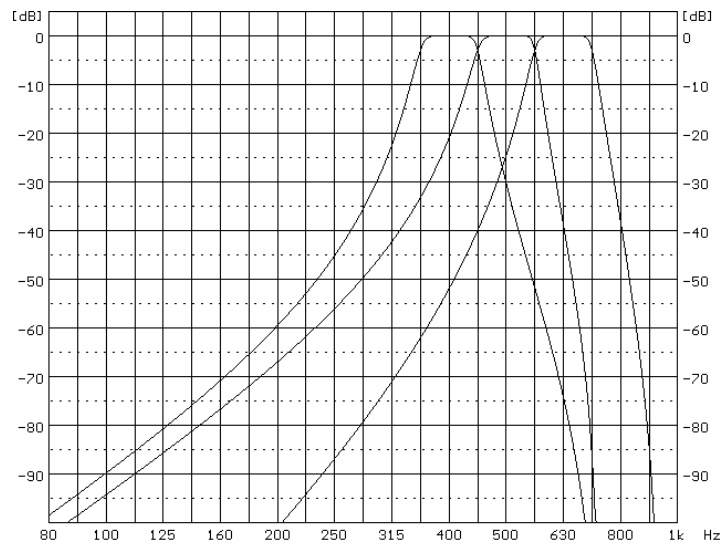
1/3 octave filters for 4.0 kHz 1/1 octave filter



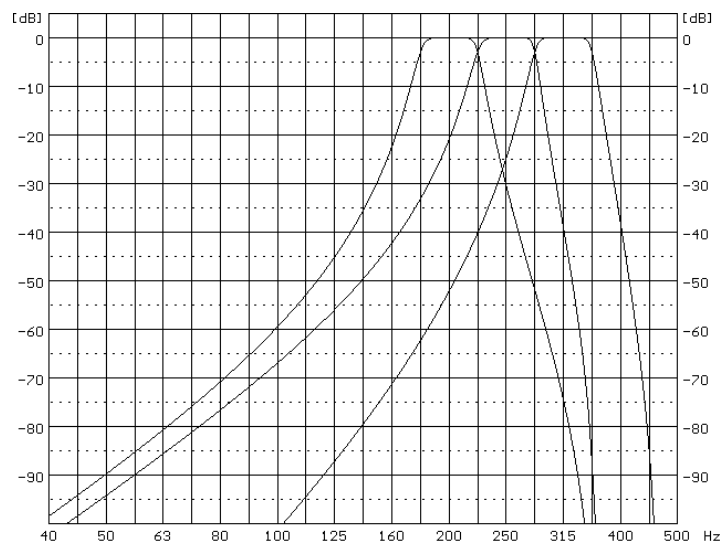
1/3 octave filters for 2.0 kHz 1/1 octave filter



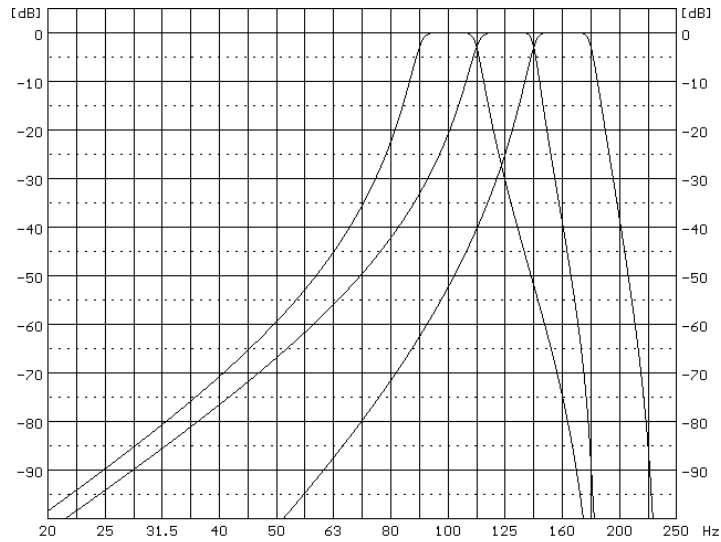
1/3 octave filters for 1.00 kHz 1/1 octave filter



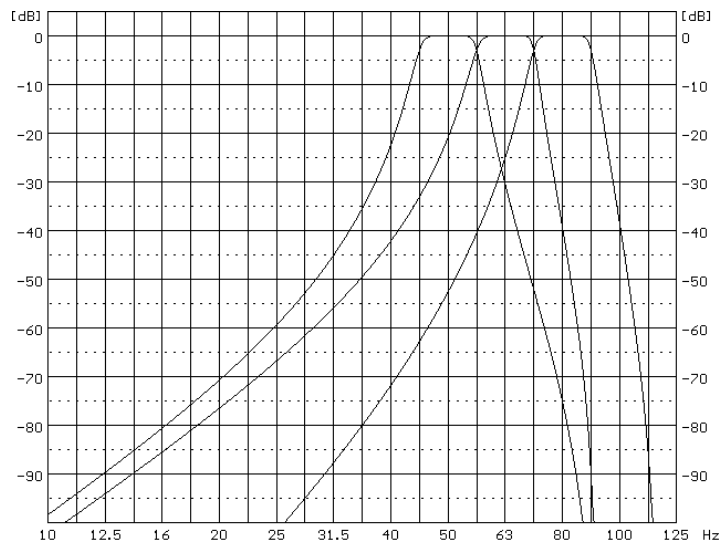
1/3 octave filters for 500 Hz 1/1 octave filter



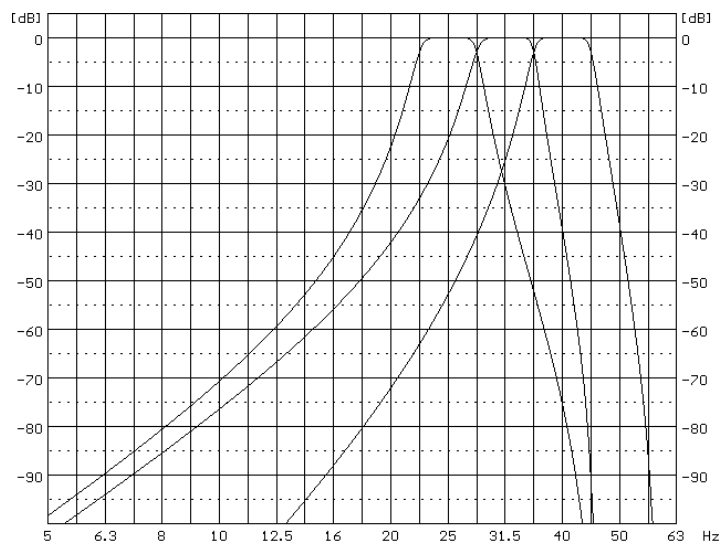
1/3 octave filters for 250 Hz 1/1 octave filter



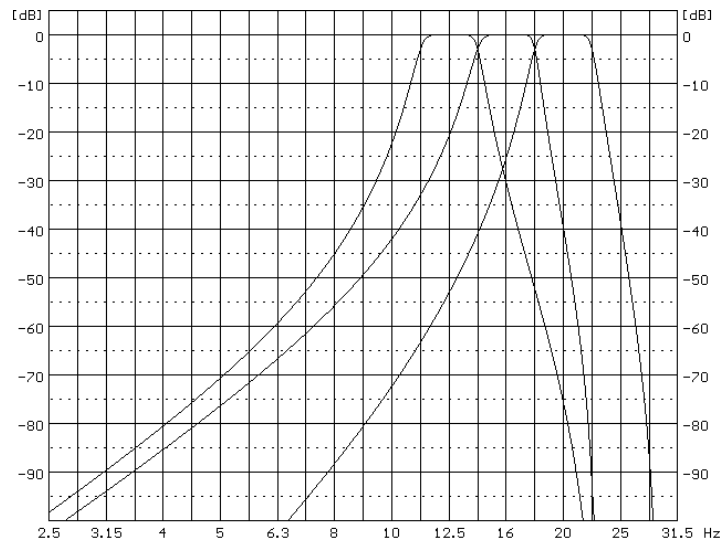
1/3 octave filters for 125 Hz 1/1 octave filter



1/3 octave filters for 63.0 Hz 1/1 octave filter



1/3 octave filters for 31.5 Hz 1/1 octave filter

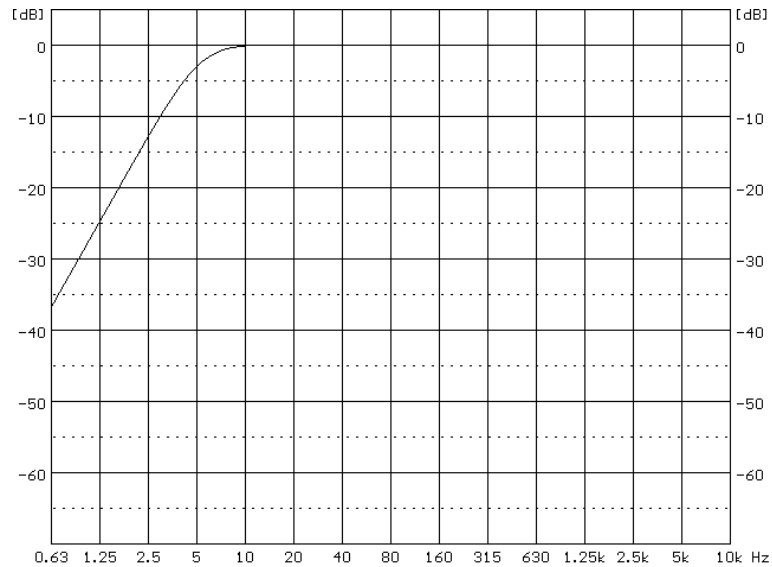


1/3 octave filters for 16.0 Hz 1/1 octave filter

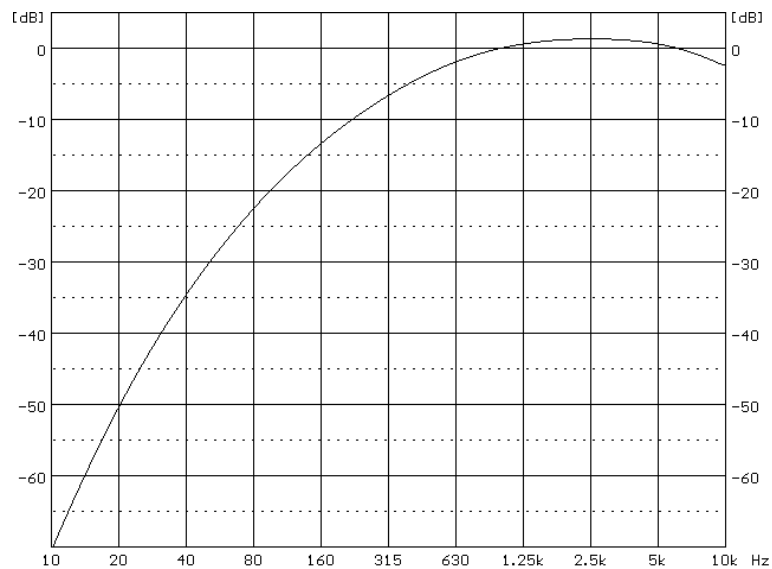
C.3 FREQUENCY CHARACTERISTICS OF THE IMPLEMENTED DIGITAL FILTERS

Digital weighting filters implemented in dose and octave mode

Z Filter: Class 2 according to the IEC 61672-1:2013 standard.

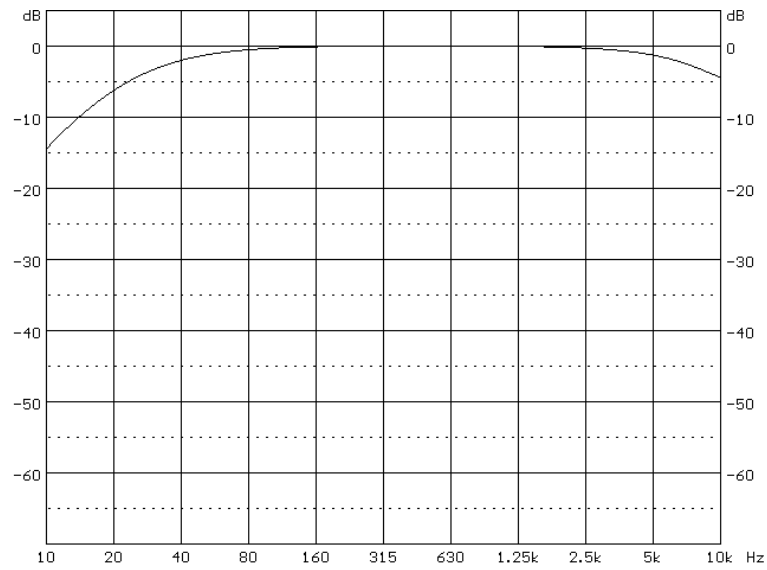


A Filter: Class 2 according to the IEC 61672-1:2013 standard.



C Filter

Class 2 according to the IEC 61672-1:2013 standard.



The weighting filters, which are available in sound modes (**Z**, **A**, and **C**) are selected in thru SUPERVISOR software under the settings window.

C.4 GENERAL SPECIFICATION OF THE SV 104BIS

Signal input

The input of the measured signal (mounting head):

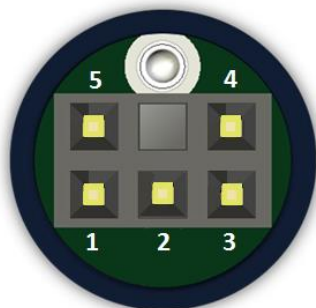


Figure C.10 ST 104B microphone connector (mounting head outer view)

Table C.6 Pin out of the microphone connector

Pin Number	Function
1	“SIGNAL” Input channel 1
2	2.8V/5mA supply DC voltage
3	“SIGNAL” Input channel 2
4	TEDS
5	GND
Chassis	Ground

Power supply

The instrument is dedicated for the operation from the internal rechargeable battery only.

- Instrument is dedicated for the operation from the internal rechargeable battery.
- Power consumption 14 mA³ under measurement run from 3.7V internal cells.
- Typical operating time from internal single Li-ion rechargeable batteries is about **45 hours**.
- The recommended charging docking station is: **SB 104B-1, SB 104B-5**.
- Power consumption from the external ---6V source is approx. 190 mA (250mA max) at + 20°C under battery charging,
- Internal rechargeable battery is protected against overcurrent and overvoltage conditions. Safety Maximum Charging Current for Li-ion cells used in SV 104B is 725 mA and Maximum Charging Voltage is 4.4 VDC.



Note: For the temperatures below 10°C operating time can decrease.



Note: The equipment shall only be charged in non-hazardous area by manufacturer's chargers on a fireproof surface.

³ display off, octave/one-third analysis off

Communication Interface and external Power Connector

The SV 104BIS electrical interface enables remote control of the instrument and data transfer up to attainable with 3 MHz clock.

“Client” communication port

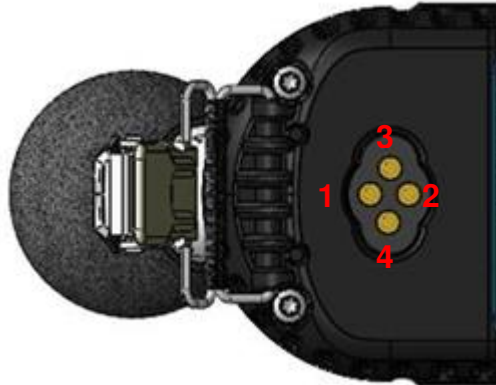


Figure C.11 Power and Communication Port (external bottom view)

Table C.7 Pin-out of the electrical interface

Pin number	Function
1	Power supply: $\approx 6V \pm 1.3V$ NOTE: $U_m=8V$
2	Ground
3	Receiver
4	Transmitter

Real Time Clock	built-in, accuracy better than 1 minute/month
Weight with the battery	~140 g (SV 104BIS with mounting clips and ST 104B and SA 122BIS)
Dimensions	90x50x31 mm (base: no microphone, no mounting accessories).

Safety

The product described above is compliant with following standards: EN/IEC 61010-1:2010




Note: The measurement circuit is safety category I according to EN/IEC 61010-1:2010 standard. This measurement equipment should not be used for measurements in categories II, III, IV. The input voltage should be within the 30 V Peak – Peak.

Category I equipment: dedicated to measurements performed on circuits not directly connected to mains, such as circuits not derived from mains or protected mains-derived circuits, including low-voltage circuits from power supplies.



Note: SV 104BIS acoustic measurement is contactless.

The device marked with symbol , meaning:

ATTENTION, CONSULT ACCOMPANYING DOCUMENTS

Environmental Ingress Protection: **IP65** per EN 60529:1991/A2:2013 (IEC 60529:1989/Amd2:2013). Dust-tight. Protected against water jets. Suitable for outdoor use.

Environmental parameters

Dedicated for indoor and outdoor use:

Operating temperature range	-10°C ÷ +50°C
Storing temperature range	-20°C ÷ +50°C
Charging temperature range	0°C ÷ +35°C
Humidity	≤ 90% RH in 40°C (uncondensed vapour)
Atmospheric pressure	80 kPa ÷ 110 kPa
Atmosphere	air with normal oxygen content, typically 21% v/v

WIRELESS BLUETOOTH 5.2 CONNECTIVITY

This dosimeter supports wireless connection via Bluetooth® 5.2 (Low energy). This connectivity is compatible with mobile and PC devices that support Bluetooth® 5.2.

- TX power: up to 8 dBm
- Receiver sensitivity: -90 dBm
- Range: typically, ≤50m line-of-sight and depending on local RF conditions.

The instrument contains a wireless transmission module, BGM121 from Silicon Laboratories. Copies of the modules regional approvals certificates may be obtained from Svantek or Silicon Laboratories.

- Declaration ID: D033250, Controller Subsystem Qualified Design ID: 88831

FCC and ISEDC

This product contains an FCC and Industry Canada certified Bluetooth® Low energy wireless transmission module:

- **FCC IDENTIFIER:** QOQBGM12LMA
- **Industry Canada IC:** 5123A-BGM12LMA
- Producer: Silicon Laboratories Inc.
- Model: BGM121V Bluetooth smart module
- Modular Type: Single Modular

FCC Statements:

This device complies with Part 15 of the FCC Rules. Operation is subject to the following two conditions:

- (1) this device may not cause harmful interference, and
- (2) this device must accept any interference received, including interference that may cause undesired operation

This equipment complies with FCC radiation exposure limits set forth for an uncontrolled environment. End users must follow the specific operating instructions for satisfying RF exposure compliance. This transmitter meets both portable and mobile limits as demonstrated in the RF Exposure Analysis and SAR

test report. This transmitter must not be co-located or operating in conjunction with any other antenna or transmitter except in accordance with FCC multi-transmitter product procedures.

ISED Statements:

This radio transmitter has been approved by Industry Canada to operate with its embedded antenna. Other antenna types are strictly prohibited for use with this device. This device complies with Industry Canada's license-exempt RSS standards. Operation is subject to the following two conditions:

- (1) this device may not cause interference, and
- (2) this device must accept any interference, including interference that may cause undesired operation of the device.

Exception from routine SAR evaluation limits are given in RSS-102 Issue5. BGM121N meets the given requirements when the minimum separation distance to human body is less than equal to 15 mm. RF exposure or SAR evaluation is not required when the separation distance is 15 mm or more. BGM121A module has been tested for worst case RF exposure. As demonstrated in the SAR test report, BGM121A and BGM123A can be mounted in touch with human body without further SAR evaluation.

Compliance with EU Directives

CE mark indicates compliance with:

- **RED**, Radio Equipment Directive 2014/53/EU
- **RoHS2**, Restriction of Hazardous Substances in Electrical and Electronic Equipment 2011/65/EU
- **WEEE**, Waste of Electrical and Electronic Equipment 2012/19/EU

APPENDIX D DEFINITIONS AND FORMULAE OF MEASURED VALUES

D.1 BASIC TERMS AND DEFINITIONS

T	Current time period of the measurement in seconds.
T₁	Last second of the measurement.
T_e	Exposure time in seconds (time period during which a person is exposed to the action of noise). This parameter can be set in the Exposure Time setup (Measurement menu). The available values are from 1 minute to 12 hours with 1-minute step.
T_{8h}	Time period equal to 8 hours (28 800 seconds).
τ	Exponential time constant in seconds for the giving time-weighting. Three time constants are available: Slow (1000 ms), Fast (125 ms), Impulse (35 ms, but on falling values a longer time constant of 1500 ms is applied).
W	Frequency-weighting filter: A , C , B or Z .
p_w(t)	Instantaneous frequency-weighted sound pressure with the weighting filter W . Sound pressure is expressed in pascals (Pa).
p_{wτ}(t)	Instantaneous frequency and time-weighted sound pressure with the weighting filter W and time constant τ calculated from the equation: $p_{w\tau}(t) = \sqrt{\frac{1}{\tau} \int_{-\infty}^t p_w^2(\xi) e^{-(t-\xi)/\tau} d\xi}$
	where: ξ – variable of integration.
r(t)	Instantaneous sound pressure depends on the <RMS Integration> parameter: $r(t) = \begin{cases} p_w(t) & \text{RMS Integration = Lin} \\ p_{w\tau}(t) & \text{RMS Integration = Exp} \end{cases}$
p₀	Reference value (20 μPa).
log(x)	Logarithm of x to the base 10.
Q	Exchange rate in decibels is equal to 2, 3, 4, 5 or 6. The value of Q influences the calculations of dose meter results, namely DOSE , D_{8h} and LAV . The exposure rate equal to 3 complies with ISO R 1999 “Assessment of Occupational Noise Exposure for Hearing Conservation Purposes”, while Q equal to 5 complies with the American “Occupational Safety and Health Act” – OSHA.

- q** Value of q is used in the calculations of **DOSE**, **D_8h** and **LAV** is taken from the formula
- $$q = \begin{cases} \frac{Q}{\log 2} & \text{for } Q \neq 3 \\ 10 & \text{for } Q = 3 \end{cases}$$
- L_T** Threshold sound level set in the **Threshold Level** via the SUPERVISOR software. The available values are as follows: **None**, **60dB** up to **90dB** in 5 dB steps.
- L_c** Criterion sound level set in the **Criterion Level** set via the SUPERVISOR software. The available values are from **60dB** up to **90dB** in 5 dB steps.
- L(t)** Sound level (a function of time) measured with the selected time constant (**IMPULSE**, **FAST** or **SLOW**) and the weighting filter (equal to **A**, **C** or **Z**)
- $$L(t) = 20 \log \frac{p_w(t)}{p_0}$$
- L_d(t)** Sound level (a function of time) depends on the selected threshold level.

In case the **None** option is selected

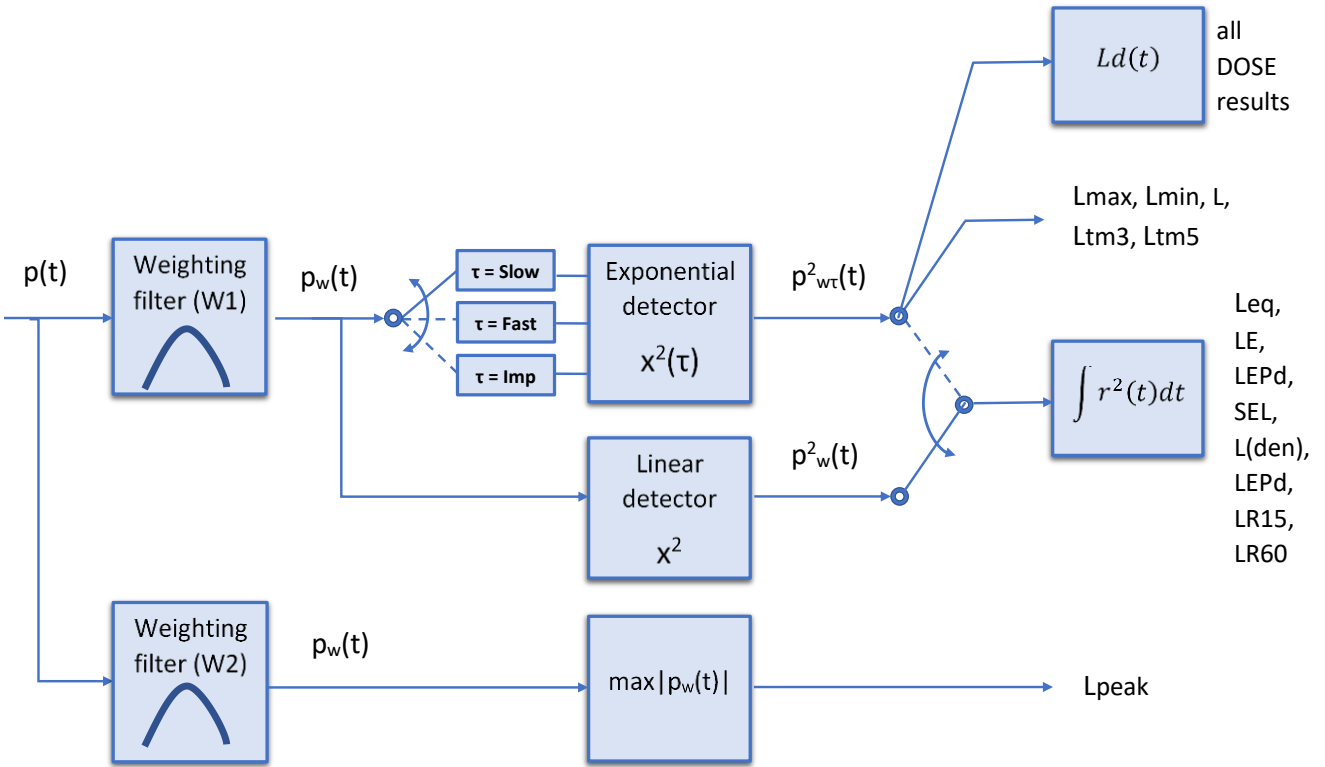
$$L_d(t) = L(t)$$

In other cases (when the **Threshold Level** set via the SUPERVISOR software is not set to none and equal to **60 dB** ... or up to **90 dB**)

$$L_d(t) = \begin{cases} L(t) & \text{for } L(t) \geq L_T \\ -\infty & \text{for } L(t) < L_T \end{cases}$$

D.2 DEFINITIONS AND FORMULAS OF THE SLM FUNCTION RESULTS

The instrument calculates the sound measurement results for three profiles. The calculation flow diagram for one profile is presented below:



OVL Percentage of the overloaded input signal, which occurred during the current time period of the measurement (**T**)

L(A/C/Z)peak Peak sound level expressed in dB, for frequency weightings A, C, Z, symbols are **LApeak**, **LCpeak** and **LZpeak**. Peak sound level is calculated for the given **T**.

$$\text{Peak} = 10 \log \left(\max_T \frac{p_w^2(t)}{p_0^2} \right)$$

L(A/C/Z)(S/F/I) max The highest time weighted sound level (**Max**) expressed in dB, within a stated time interval, for frequency weightings A, C, Z and time weightings F, S, I symbols are **LAFmax**, **LASmax**, **LCFmax**, **LCSmax** etc.

$$\text{Max} = 10 \log \left(\max_T \frac{p_{w\tau}^2(t)}{p_0^2} \right)$$

L(A/C/Z)(S/F/I) min	The lowest time weighted sound level (Min) expressed in dB, within a stated time interval, for frequency weightings A, C, Z and time weightings F, S, I symbols are LAFmin , LASmin , LCFmin , LCSmin etc.	$\text{Min} = 10 \log \left(\min_T \frac{p_{wT}^2(t)}{p_0^2} \right)$
L(A/C/Z)(S/F/I)	Time weighted sound level expressed at observation time, expressed in dB, for frequency weightings A, C, Z and time weightings F, S, I symbols are LAF , LAS , LCF , LCS etc.	$L = 10 \log \left(1/\tau \frac{p_{wT}^2(t)}{p_0^2} \right)$
L(A/C/Z)eq	Time averaged equivalent continuous sound level (Leq) expressed in dB, for frequency weightings A, C, Z symbols are LAEq , LCeq and LZeq . In principle time weighting is not involved in a determination of time averaged sound level. Time-averaged sound level is calculated for current time period of the measurement (T).	$\text{Leq} = 10 \log \left(\frac{1}{T} \int_0^T (r(t)/p_0)^2 dt \right)$
L(A/C/Z)E	Sound Exposure Level (SEL) expressed in dB, for frequency weightings A, C, Z symbols are LAE , LCE and LZE . SEL is essentially the subset of the Leq result. Its value is equal to the Leq result referred to the integration time equal to one second (so, for the Integration time equal to 1 s, SEL is always equal to Leq).	$\text{SEL} = 10 \log \left(\int_0^T (r(t)/p_0)^2 dt \right) = \text{Leq} + 10 \log \frac{T}{1s}$
LEPd	Daily Personal Noise Exposure is the noise exposure level for a nominal 8-hour working day. The LEPd result is calculated on the base of the LEQ	$\text{LEPd} = \text{Leq} + 10 \log \frac{T_e}{T_{8h}}$
LTM3 and LTM5	The LTM3 and LTM5 results (Takt-Maximal Levels) are calculated according to the German standard TA Lärm.	
Ln	Statistical level is the certain boundary level surpassed by the temporary noise level values in not more than nn % of the observation period	Example: Let us assume that L35 is equal to 76.8 dB. It means that during the measurements the noise level 76.8 dB was exceeded in not more than 35% of the observation period.

D.3 DEFINITIONS AND FORMULAS OF THE ADDITIONAL DOSIMETER FUNCTION RESULTS

DOSE	Quantity of noise received by the worker, expressed as the percentage of the whole day acceptable value.	$\text{DOSE} = \frac{100\%}{T_{8h}} \int_0^T 10^{\frac{L_d(t)-L_c}{q}} dt$
D_8h	Quantity of noise received by the worker during 8 hours.	$D_{8h} = \frac{100\%}{T} \int_0^T 10^{\frac{L_d(t)-L_c}{q}} dt = \frac{T_{8h}}{T} \cdot \text{DOSE}$
PrDOSE	Quantity of noise received by the worker during exposure time.	$\text{Pr DOSE} = \frac{100\%}{T} \int_0^T 10^{\frac{L_d(t)-L_c}{q}} dt = \frac{T_e}{T} \cdot \text{DOSE}$
LAV	Average level of the acoustic pressure for the given time period of the measurement.	$\text{LAV} = q \cdot \log \left(\frac{1}{T} \int_0^T 10^{\frac{L_d(t)}{q}} dt \right)$
SEL8	SEL result corresponding to the integration time equal to 8 hours. The SEL8 result is calculated on the base of the LEQ .	$\text{SEL8} = \text{LEQ} + 10 \cdot \log \frac{T_{8h}[\text{s}]}{1[\text{s}]}$
PSEL	Individual Sound Exposure Level to the noise is equal to the standing sound level in a measurement period. The PSEL result is calculated on the base of the LEQ .	$\text{PSEL} = \text{LEQ} + 10 \cdot \log \frac{T}{T_{8h}}$
E	Amount of the acoustical energy received by the worker.	$E = \frac{T[\text{s}]}{3600} p_o^2 \cdot 10^{\frac{\text{LEQ}}{10}}$
E_8h	The E_8h result (Exposition in 8 hours) represents the amount of the acoustical energy received by the worker during 8 hours. The E_8h result is expressed in the linear units [Pa ² h].	$E_{8h} = 8[\text{h}] \cdot p_o^2 \cdot 10^{\frac{\text{LEQ}}{10}}$
PTC	Peak Threshold Counter – the number of the overpasses of the Threshold Level by Lpeak result. This result is incremented in 100 ms intervals.	

PTP	PTC result expressed in percent.	$PTP = \frac{100 \cdot PTC}{10T_c}$
ULT	Upper Limit Time: the time that the SPL exceeded the "ULT Threshold Level" set during configuration.	
TWA	<p>Time Weighted Average is the average A-weighted sound level for a nominal 8-hour workday with Time Weighting S and Exchange Rate 5. TWA is usually measured with A-weighting and Slow response detector type. TWA is calculated from the measured LAV (taking Threshold Level into account) and a Reference time of 8 h. Mainly used in the USA for assessing the noise exposure for a worker during a workday.</p>	<ul style="list-style-type: none"> • Sound levels at or above the THRESHOLD LEVEL are averaged into the calculations relating to noise exposure. TWA is calculated with no threshold level, or with threshold level (typically 80dB or 90dB) • In case the time period is below 8 hours, the TWA is less than the LAV In case the time period is more than 8 hours, the TWA is greater than the LAV
PrTWA	Projected Time Weighted Average is calculated from the measured LAV (taking THRESHOLD LEVEL into account) and the exposure time.	
Lc-a	The C-A measurement is an Leq that enhances the low-frequency components of the sound signal. It is the result of subtracting an A-weighted LAeq from a simultaneously collected C-weighted Leq	$Lc-a = LCeq - LAeq$

D.4 STATISTICAL LEVELS – Ln DEFINITION

The noise level $L(t)$ is the continuous random variable. The probability that the temporary noise level $L(t)$ belongs to the interval $\langle L_k, L_k + \Delta L \rangle$ is called the class density and it can be expressed by the equation:

$$P_k [L_k \leq L(t) \leq L_k + \Delta L] = \sum_{i=1}^n \Delta t_i / P$$

where: Δt_i - time intervals, in which the noise level $L(t) \in \langle L_k, L_k + \Delta L \rangle$ occurs,
 ΔL - so-called class interval or distribution class of the series,
 P - total observation period.

In case when the class interval approaches infinity, the probability of $L(t)$ tends to the probability of L_k . In practice, ΔL value is strictly determined, and it depends mainly on the dynamics of the measurements performed in the instrument. There are 100 classes in the instrument and the width of each class is 1 dB. The histogram is the set of the class density values calculated for all classes.

The statistical distribution function, which determines the probability (expressed in %) of the noise occurrence on the level equal or less than $L_k + \Delta L$ is given by the formulae:

$$P[L(t) \leq L_j] = \sum_{k=1}^j P_k(L)$$

The cumulative density function, expressed by the equation:

$$P[L(t) > L_j] = 1 - P[L(t) \leq L_j]$$

is directly used to determine so-called statistical levels L_n or position parameters of the distribution.

The L_n is the certain boundary level surpassed by the temporary noise level values in not more than $n\%$ of the observation period.

Example:

Let us assume that L_{35} is equal to 76.8 dB. It means that during the measurements the noise level 76.8 dB was exceeded in not more than 35% of the observation period.

The cumulative density function for the exemplary data is presented in Figure on the right side. In order to determine the L_n level, one has to draw the horizontal cursor and find out the crossing point between the cumulative density function and the cursor. In the instrument the user can determine 10 statistical levels - from L_{01} to L_{99} (1% step of observation period).

The display in the instrument presents only first statistical level $N1$ (set to: L_{01} up to L_{99}).

The statistical level L_n value, the profile's number the statistics are taken from, the RMS detector (**Lin.**, or **Exp.: Fast, Slow** or **Imp.**), the filter's name (**A, C** or **Z**) and real time are displayed in the top-right side of the display in one-result view mode.

Exemplary cumulative density

